

SH 40101  
 Bottom X Brace for Bottom Frame SH 40102  
 Zone 40F

Folder: 08-02-19; 08-02-19; SH 40101



SH40101\_1



SH40101\_2

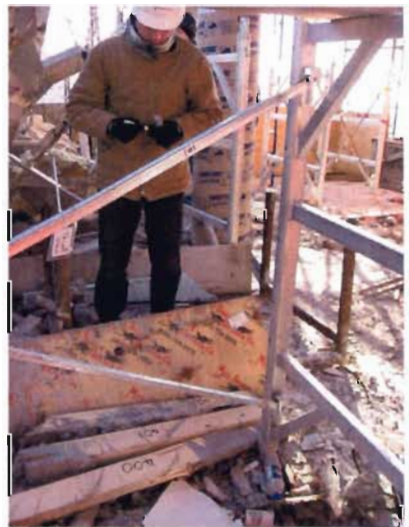

SH40101\_3

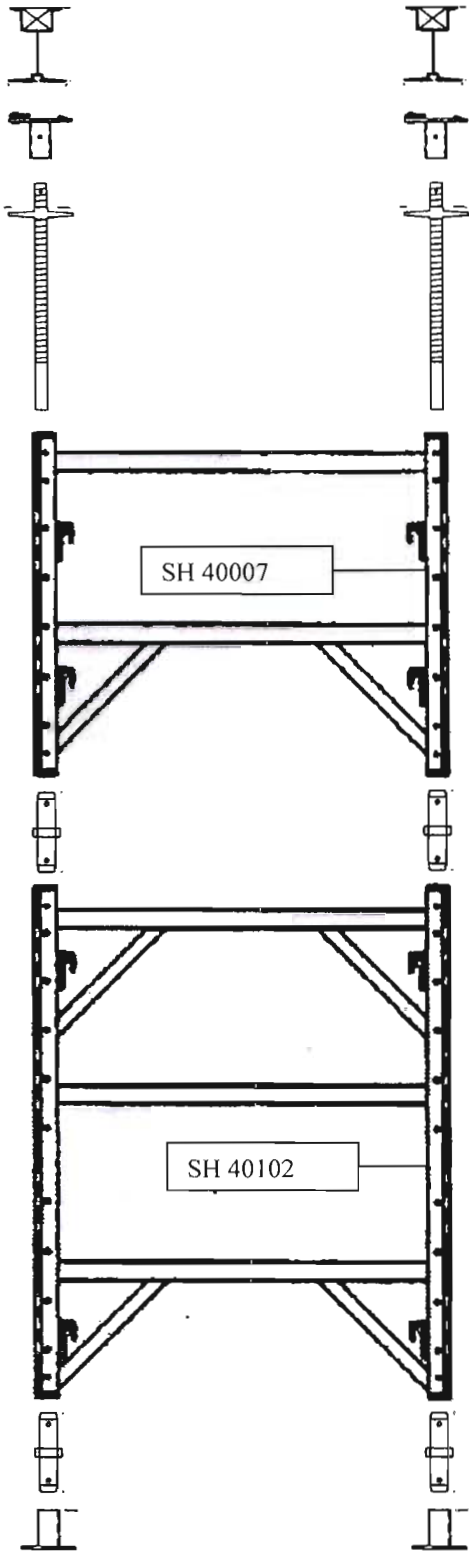

SH 40102  
 Bottom Frame of SH 40007  
 Connected to Brace SH 40101  
 Zone 40F

Folder: 08-02-19; 08-02-19; SH 40102



SH40102\_1



SH40102\_2



SH40102\_3

SH 40103 on 41<sup>st</sup> floor  
Top Shore of SH 40124  
Support AB 40014  
Zone 40F

Folder: 08-02-19; SH 40103

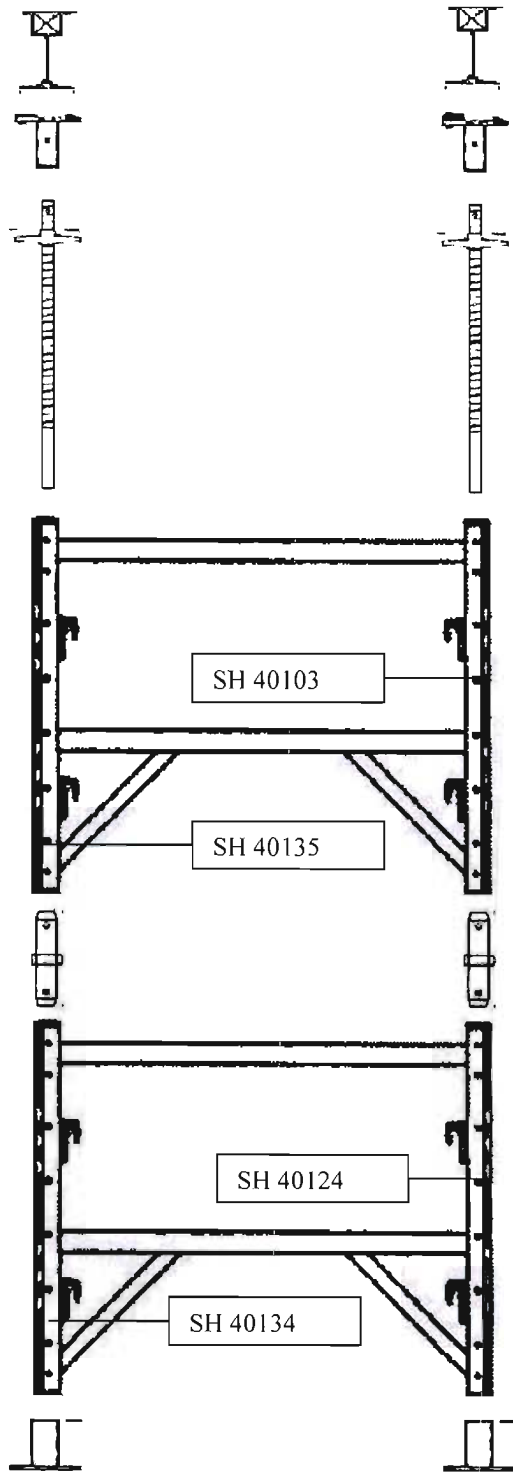

SH40103\_4



SH40103\_2



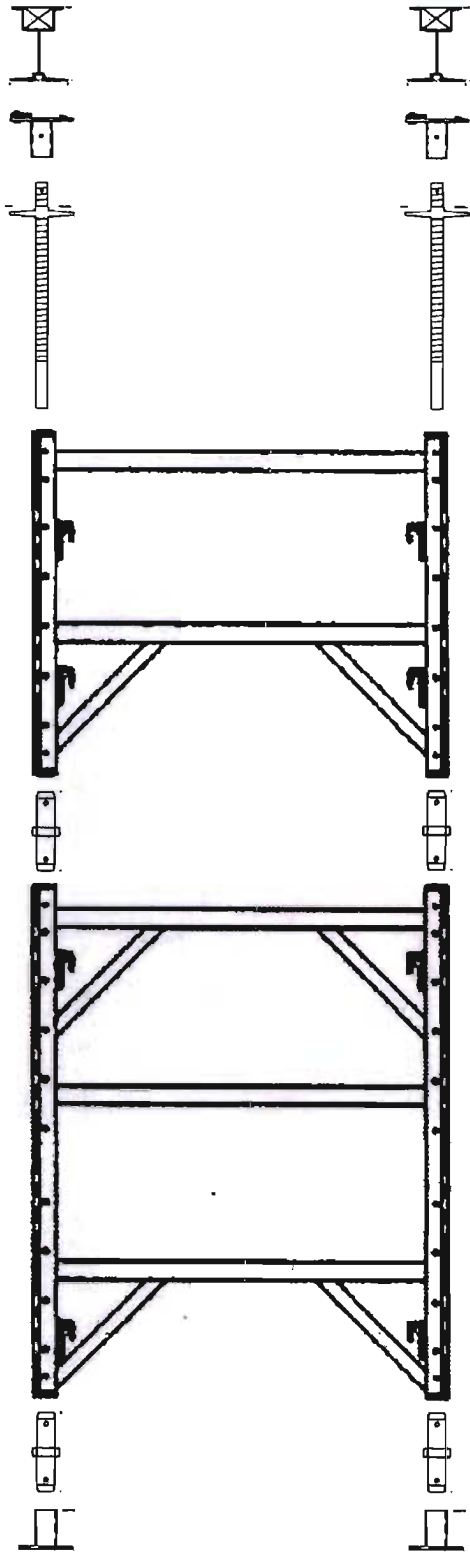

SH 40104  
 X Brace collapsed near SH 40103  
 Zone 40F

Folder: 08-02-19; 08-02-19; SH 40104



SH40104\_1



SH40104\_2



SH40104\_3

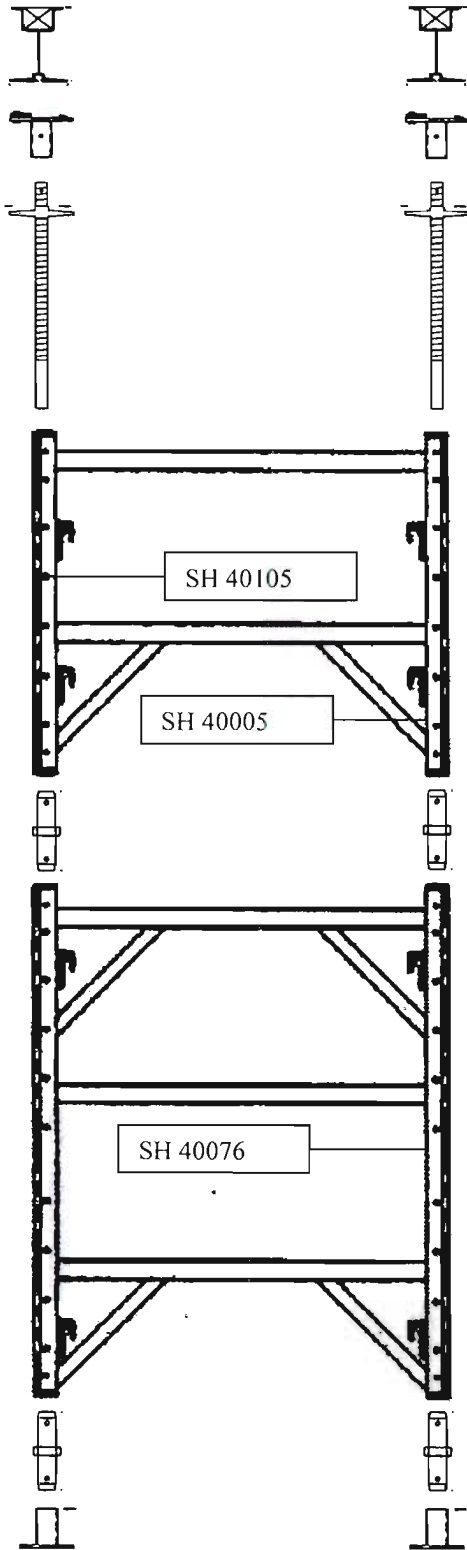

SH 40105  
 Attached to Screw Jack & Top plate  
 Supports AB 40042  
 Zone 40F

Folder: 08-02-19; 08-02-19; SH 40105



SH40105\_1



SH40105\_2



SH40105\_3

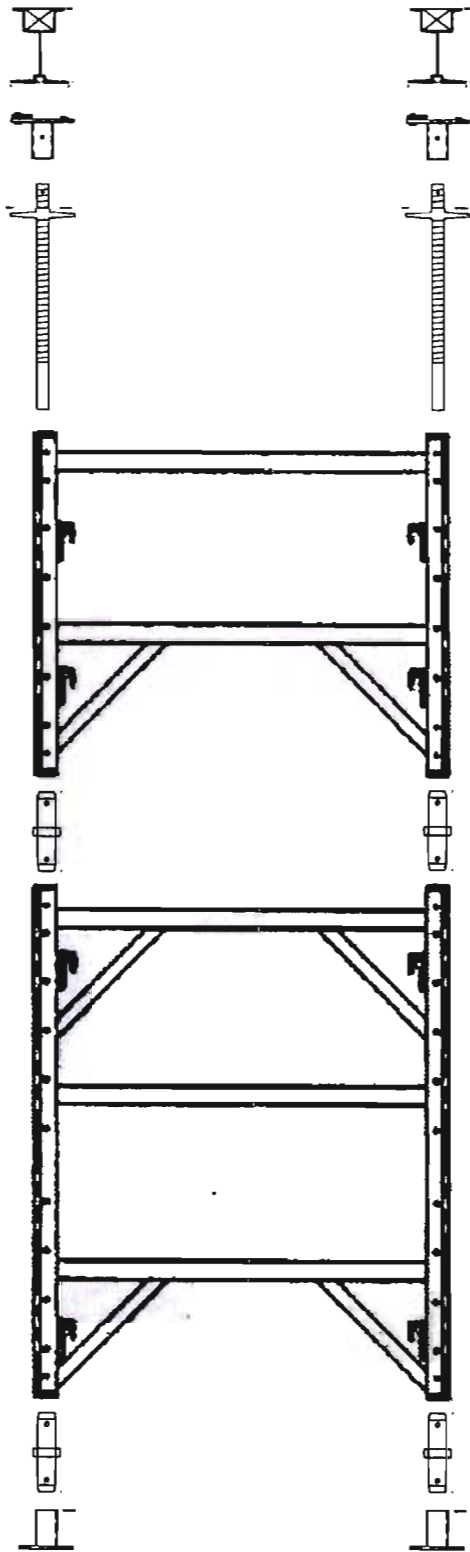

SH 40106-SH 40108

SH 40106 Bottom Plate

Zone 40F

Folder: 08-02-19; SH 40106



SH40106\_1

SH 40107

Bottom Plate

Zone 40F

Folder: 08-02-19; SH 40107

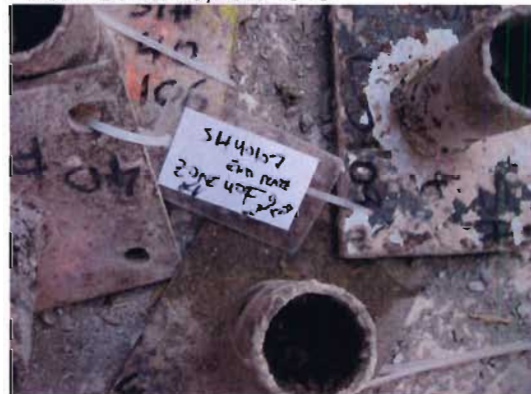

SH40107\_1

SH 40108

Bottom Plate

Zone 40F

Folder: 08-02-19; SH 40108



SH40108\_1

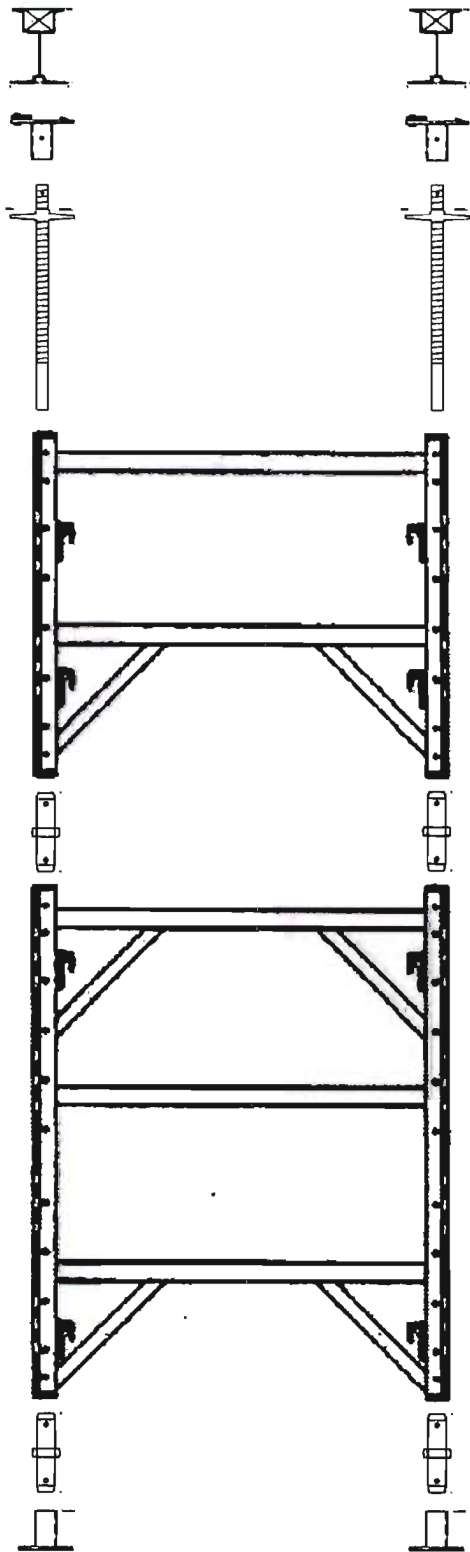

SH 40109 – SH 40110

SH 40109  
 Bottom Plate  
 Zone 40F

Folder: 08-02-19; 08-02-19; SH



SH40109\_1

SH 40110  
 Coupler  
 Moved from original position  
 Zone 40F

Folder: 08-02-19; 08-02-19; SH

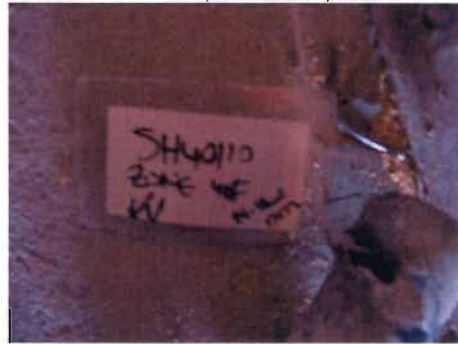

SH40110\_1



SH40110\_2



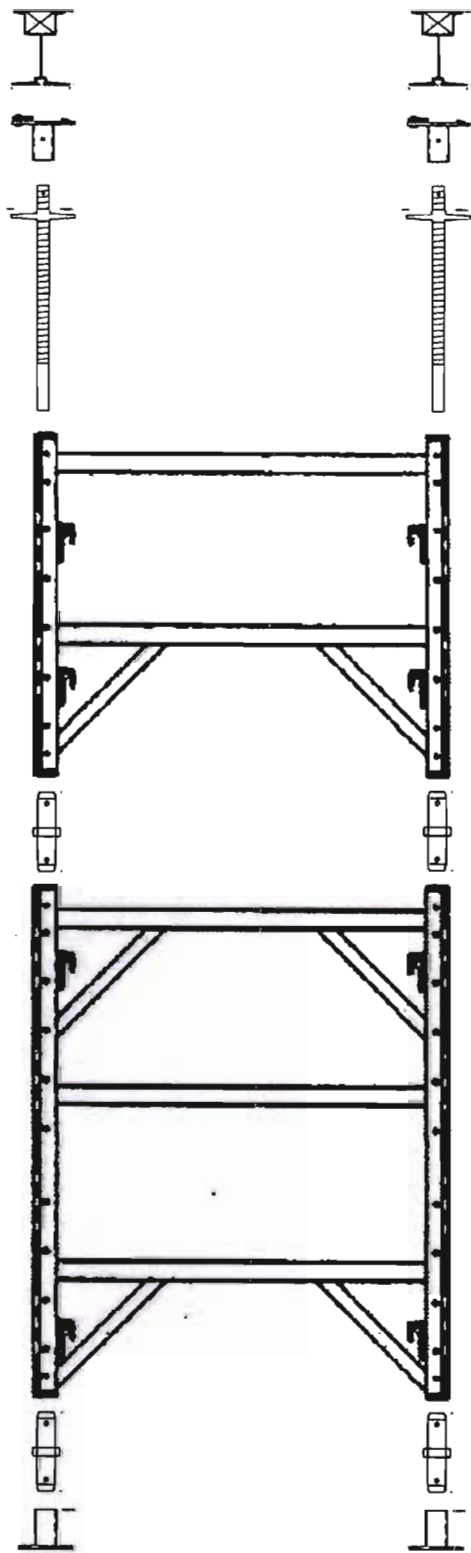

SH 40111  
 Coupler  
 Moved from original position  
 Zone 40F

Folder: 08-02-19; SH 40111

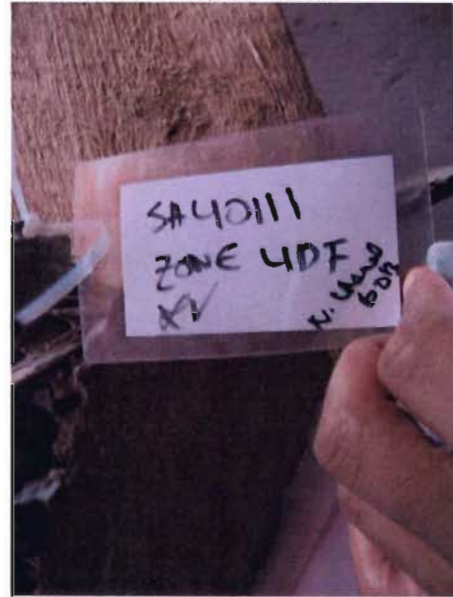

SH40111\_1



SH40111\_2



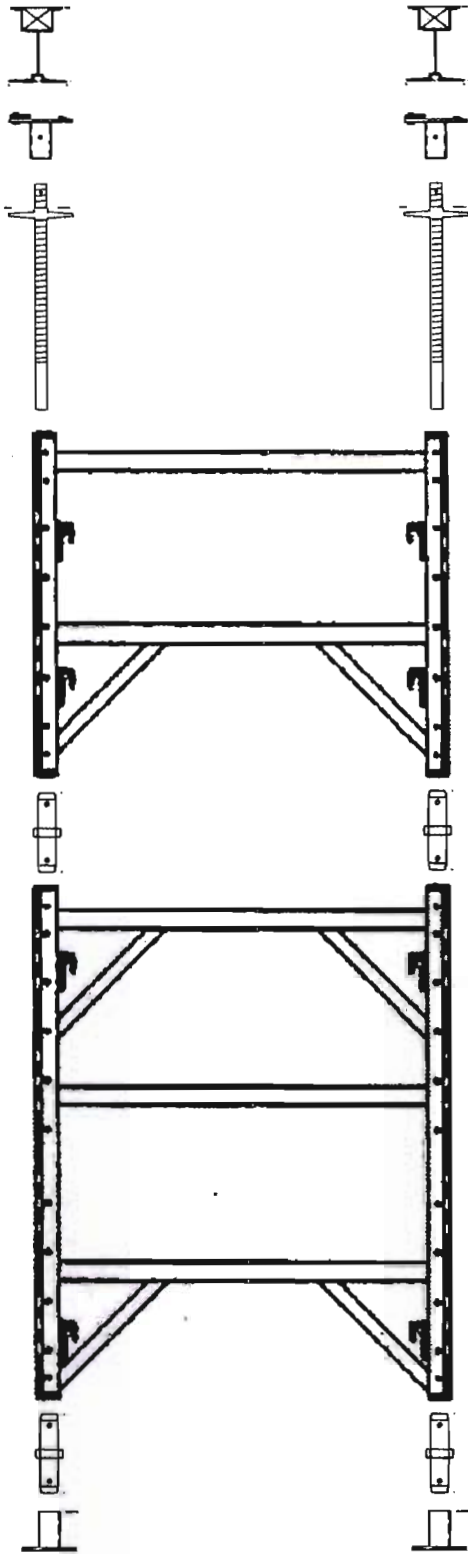

SH 40112  
Broken piece of frame  
Moved from original position  
Zone 40J

Folder: 08-02-19; SH 40112



SH40112\_1



SH40112\_2

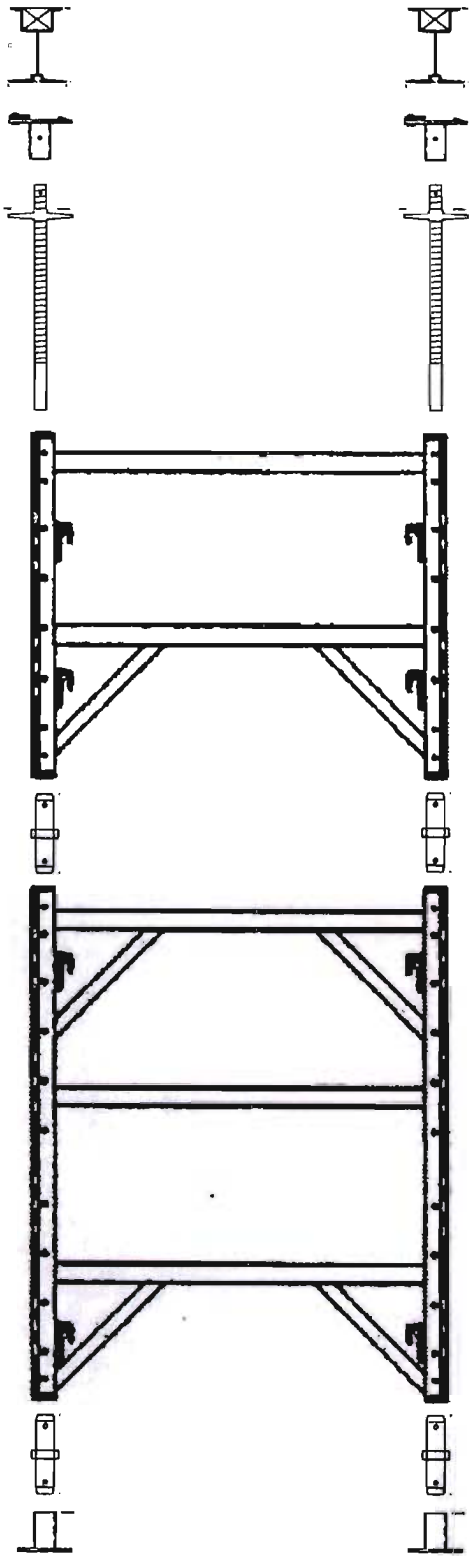

SH 40113  
 Coupler  
 Zone 40G

Folder: 08-02-19; SH 40113



SH40113\_1



SH40113\_2



SH40113\_3

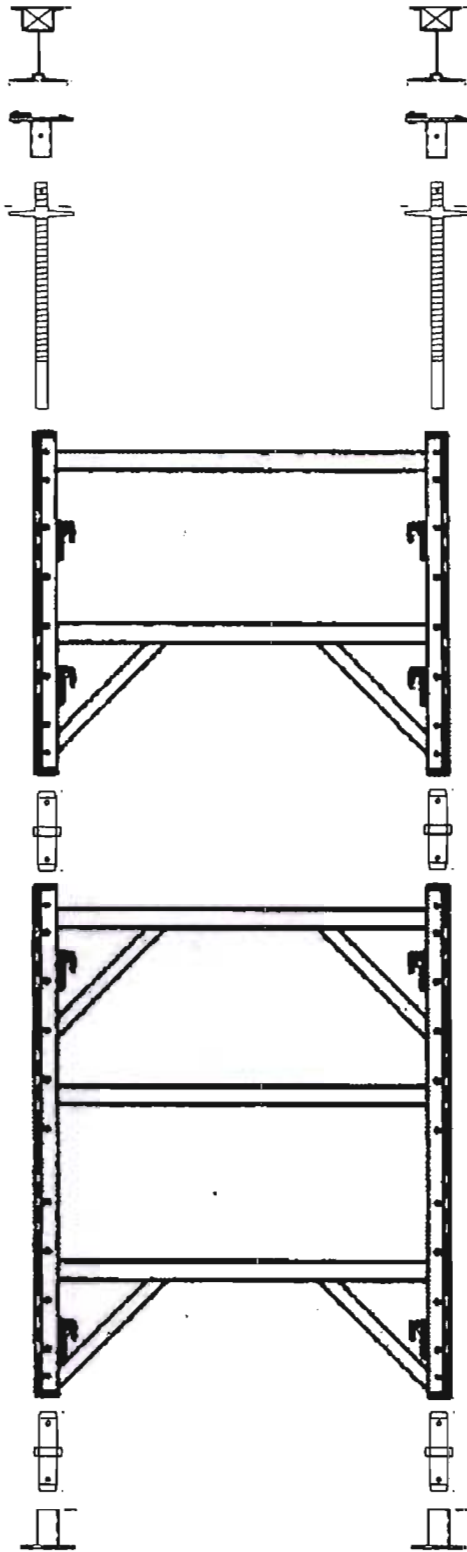

SH 40114  
 Coupler with Bottom Plate  
 Zone 40F

Folder: 08-02-19; 08-02-19; SH 40114



SH40114\_1



SH40114\_2



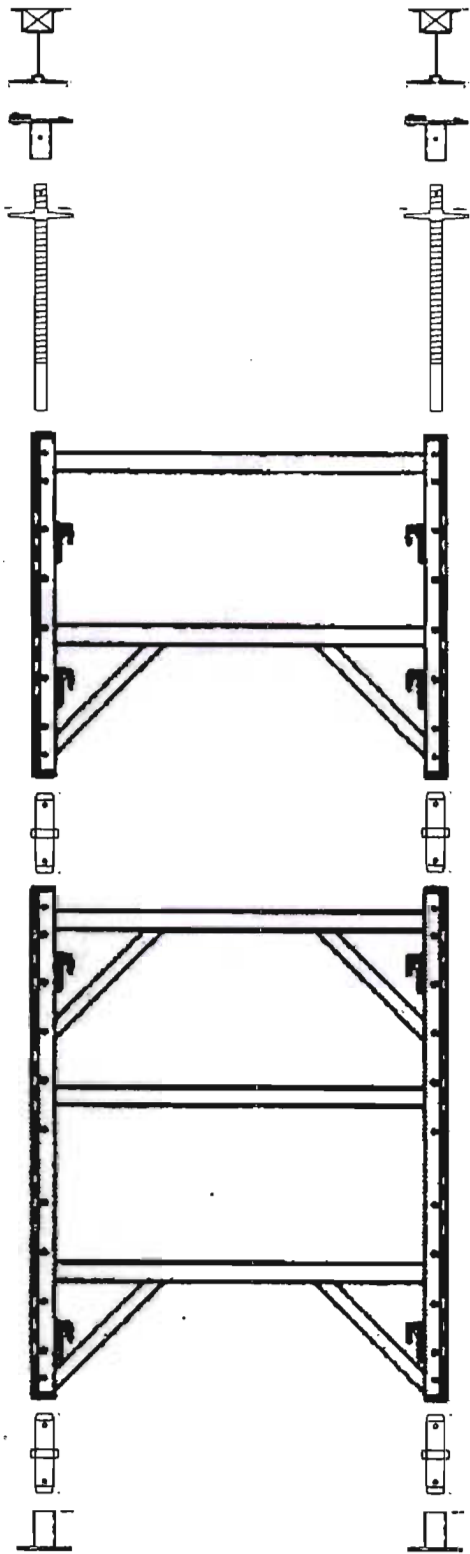

SH 40115  
 Coupler  
 Zone 40G

Folder: 08-02-19; 08-02-19; SH 40115



SH40115\_1



SH40115\_2

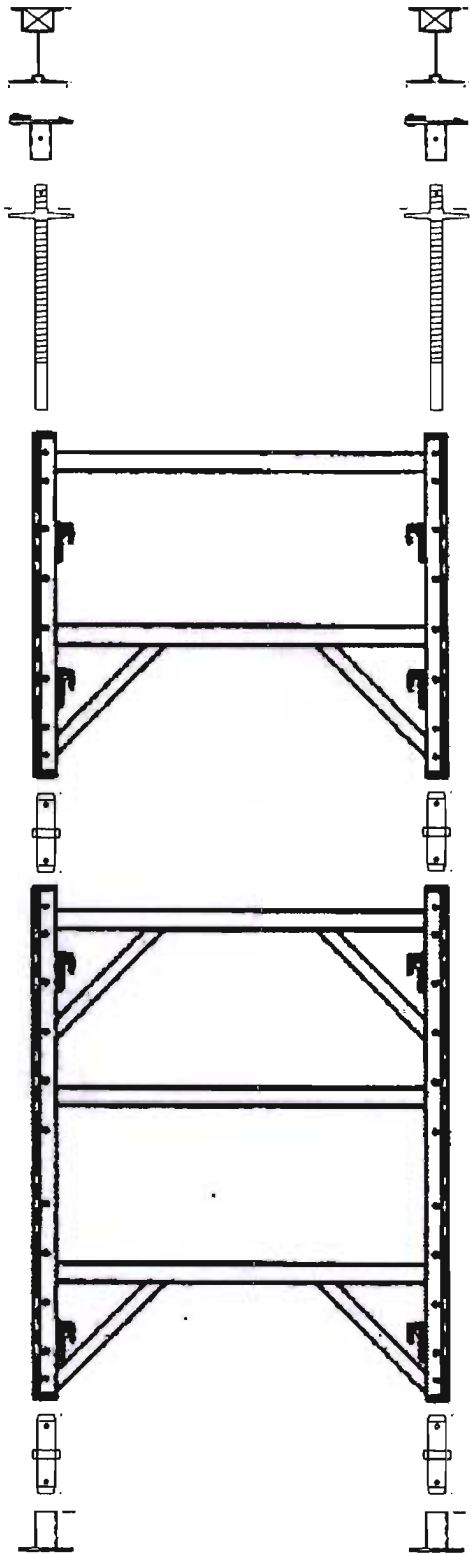

SH 40116  
 Piece of frame  
 Moved from original position  
 Zone 40F

Folder: 08-02-19; SH 40116



SH40116\_1



SH40116\_2

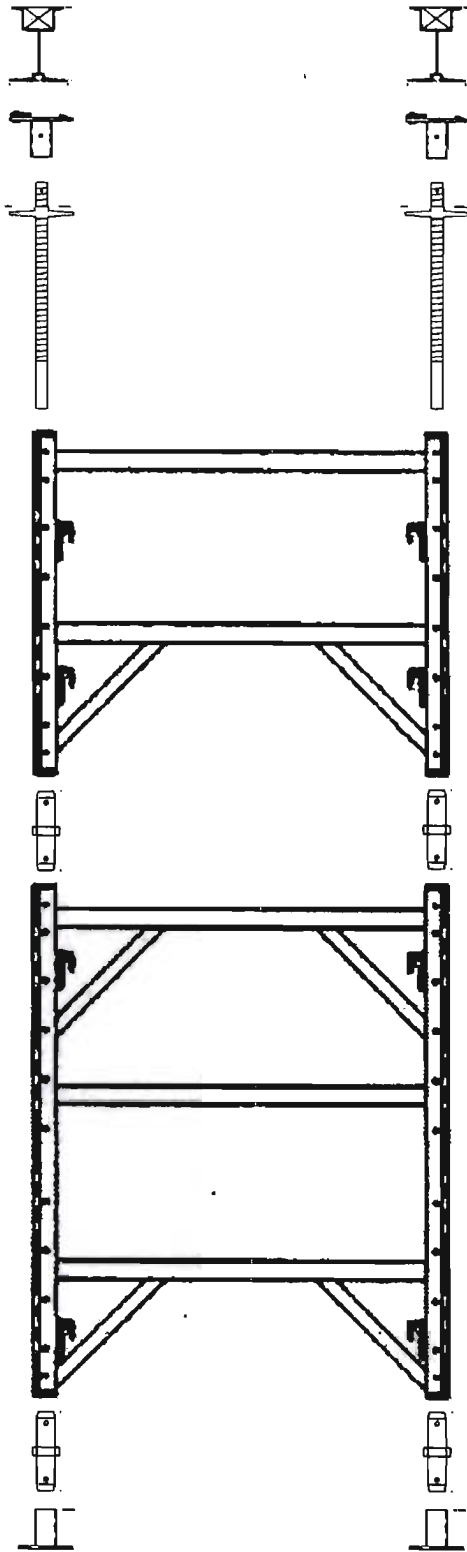

SH 40117  
Broken piece of frame found under SH  
40088 (retagged)  
Zone 40F

Folder: 08-02-19; SH 40117

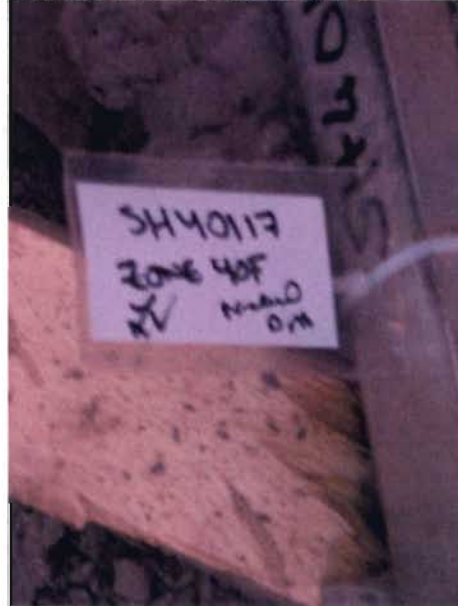

SH40117\_1



SH40117\_2



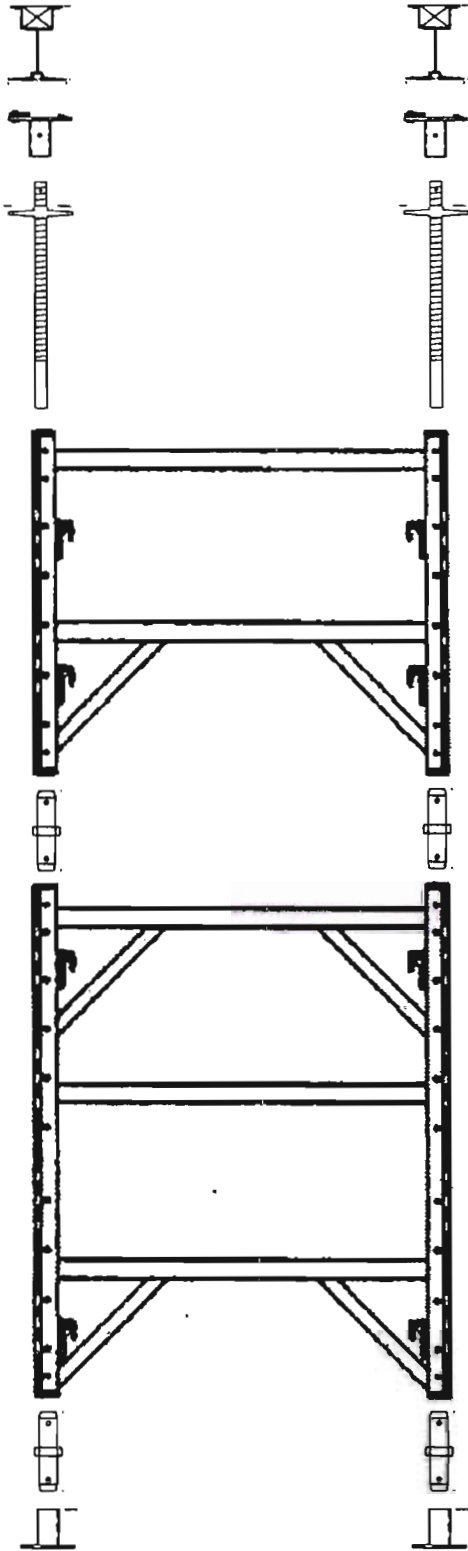

SH 40118  
Brace Connected to SH 40088  
Zone 40F

Folder: 08-02-19; SH 40118

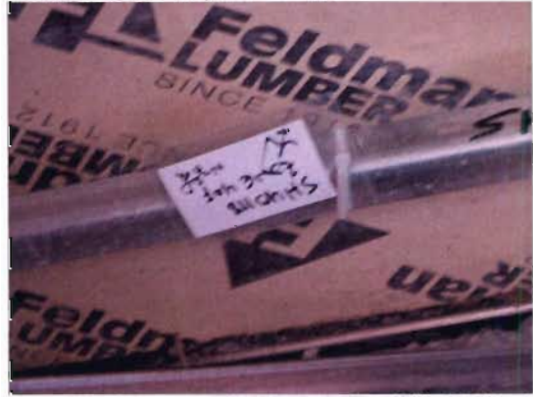

SH40118\_1



SH40118\_2

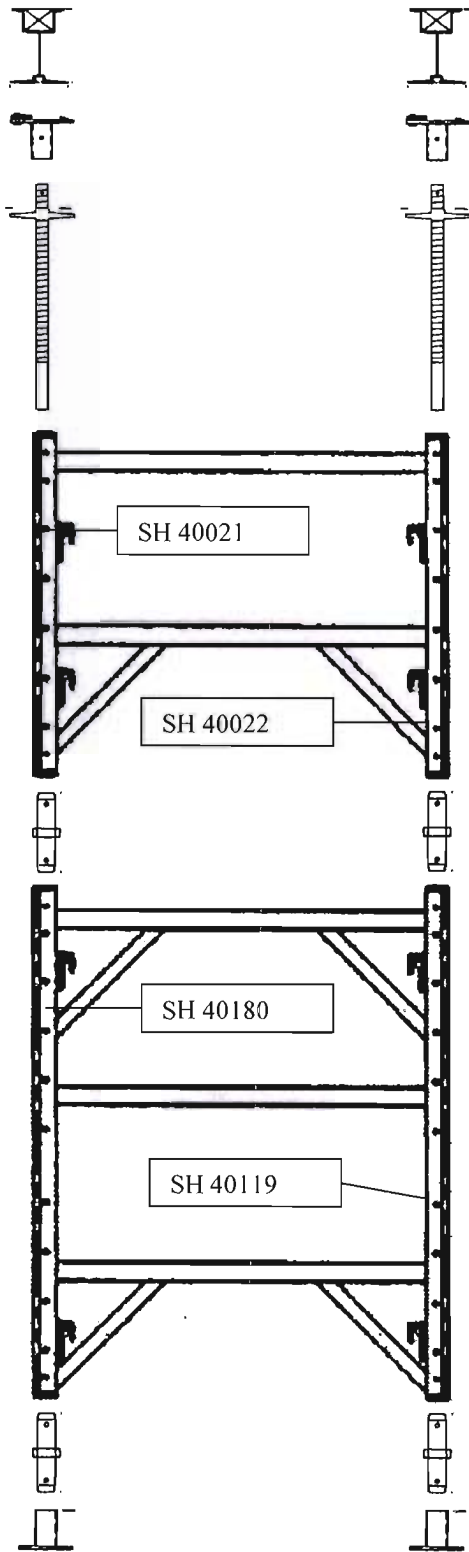

SH 40119 Bottom Shore  
 Broken with SH 40180  
 Zone 40F

Folder: 08-02-19; SH 40119



SH40119\_1



SH40119\_2

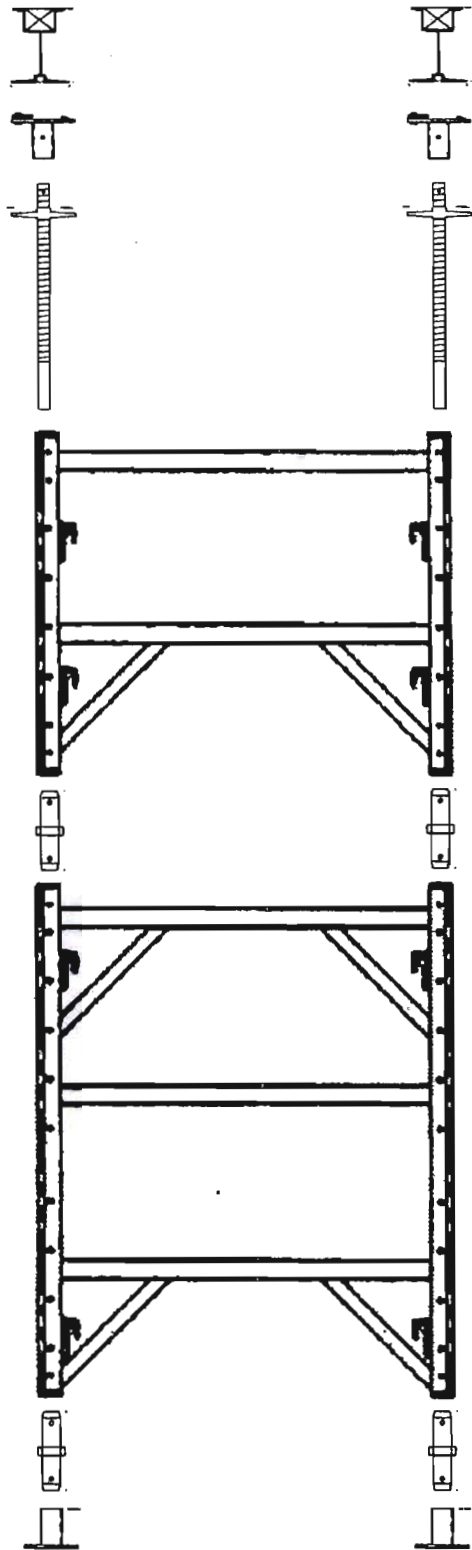

SH 40120  
Coupler  
Zone 40F

Folder: 08-02-20; SH 40120



SH40120\_1



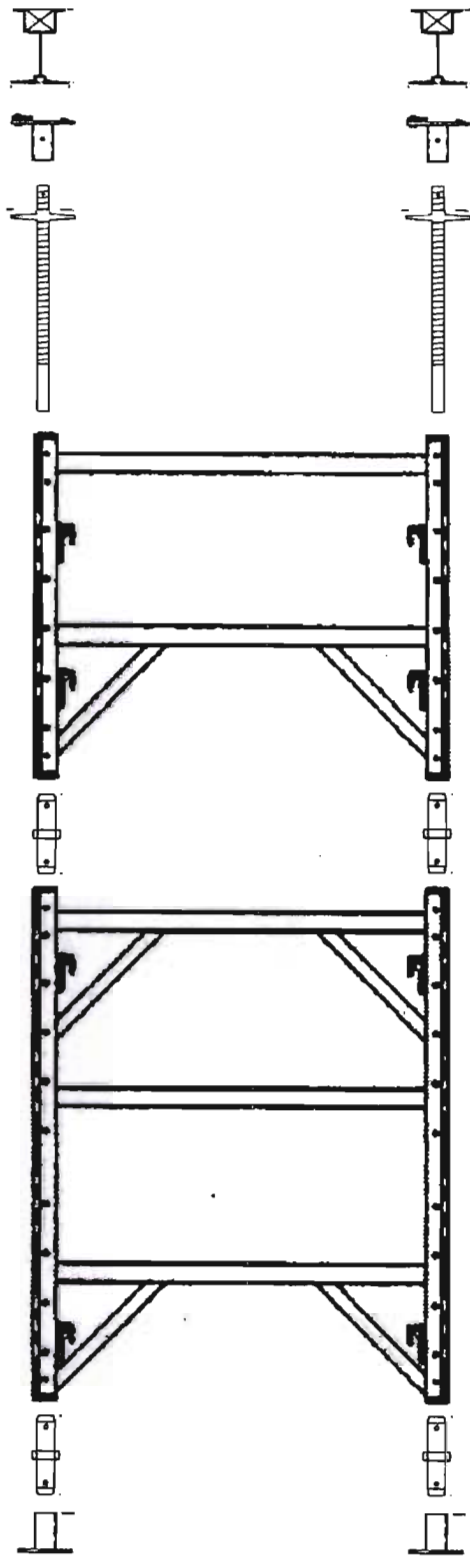

SH 40121  
 X Brace connect to SH 40119  
 Zone 40F

Folder: 08-02-19; SH 40121



SH40121\_2



SH40121\_3

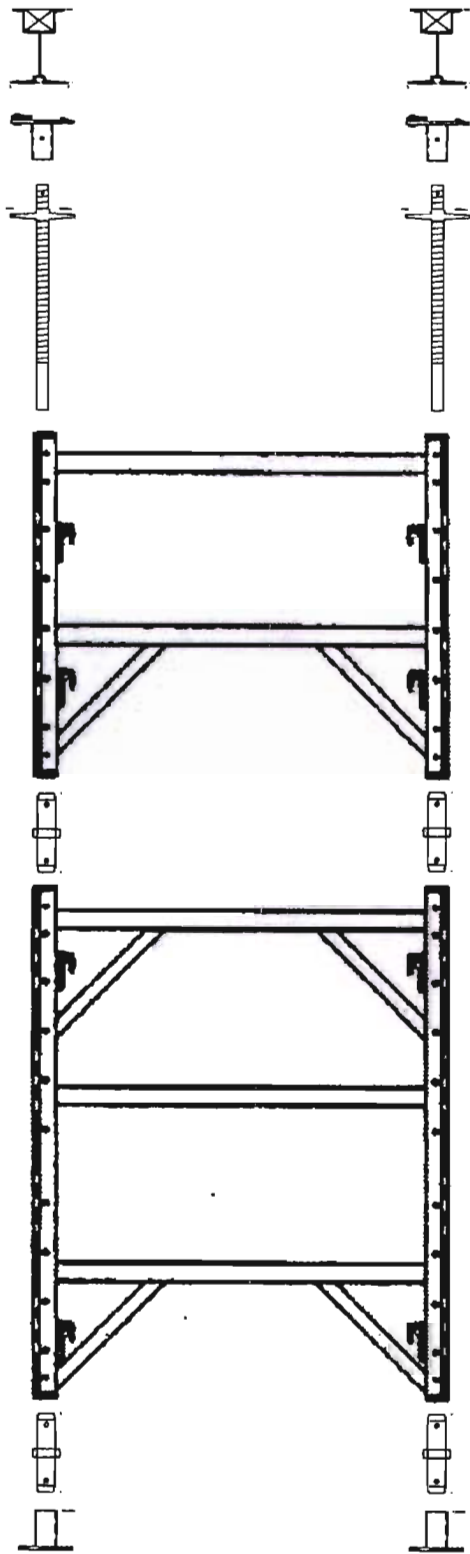

SH 40122  
 Screw Jack cut  
 Zone 40G

Folder: 08-02-20; SH 40122



SH40122\_2



SH40122\_1

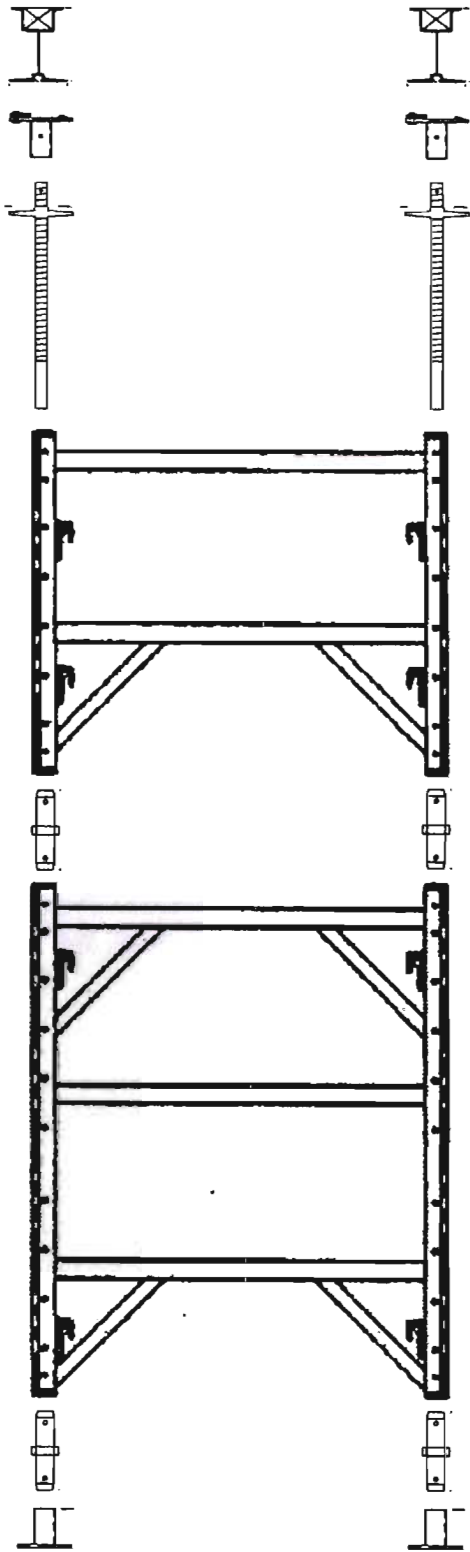

SH 40123  
 X Brace  
 Zone 40G

Folder: 08-02-20; SH 40123



SH40123\_1



SH40123\_2

SH 40124 on 41<sup>st</sup> floor  
Bottom frame of SH 40103  
Attached to bottom brace SH 40126  
Zone 40F

Folder: 08-02-20; SH 40124

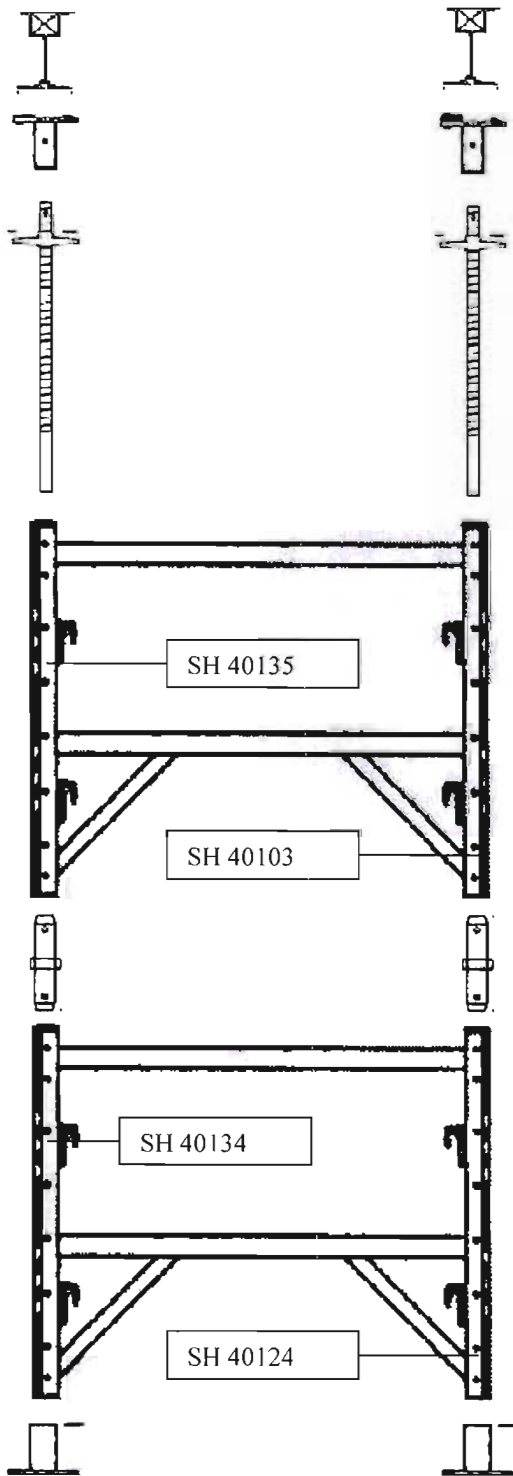

SH40124\_1



SH40124\_3



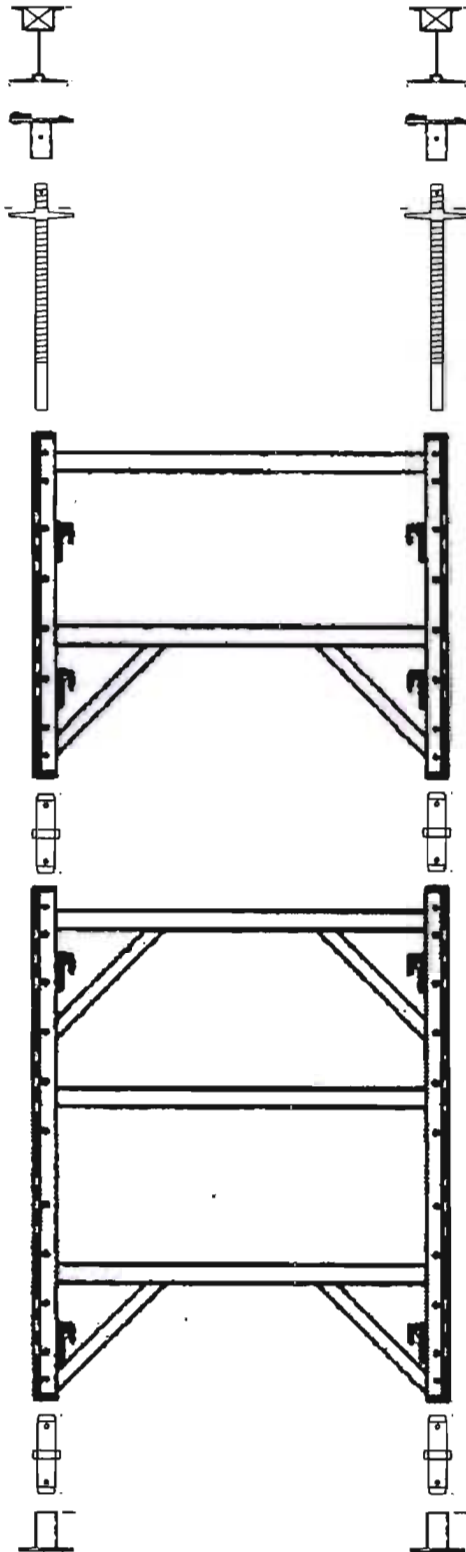

SH 40125  
 Broken piece near SH 40124  
 Zone 40G

Folder: 08-02-20; SH 40125



SH40125\_1



SH40125\_2



SH40125\_3

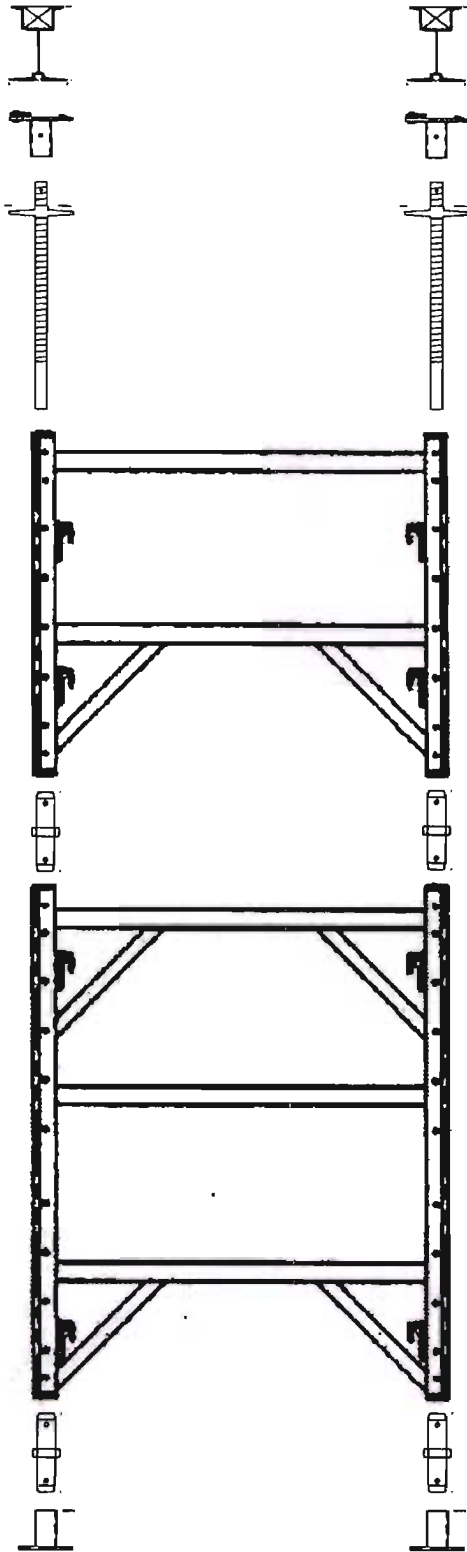

SH 40126  
Brace  
Zone 40G-F

Folder: 08-02-20; SH 40126



SH40126\_2



SH40126\_3

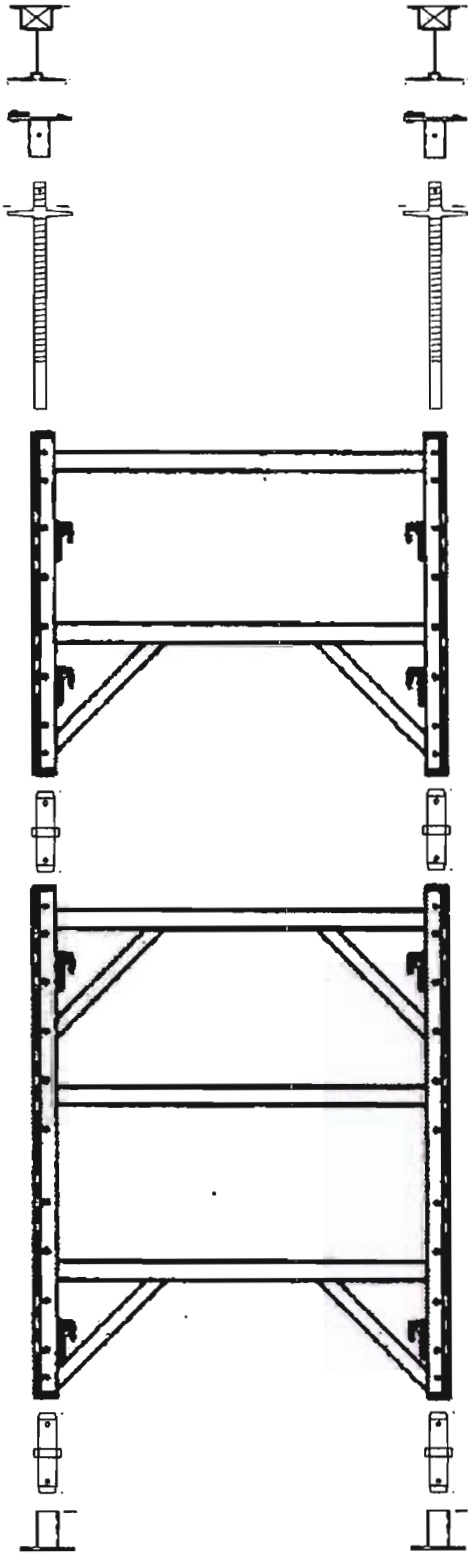

SH 40127  
Broken piece  
Zone 40F

Folder: 08-02-20; SH 40127



SH40127\_1



SH40127\_2

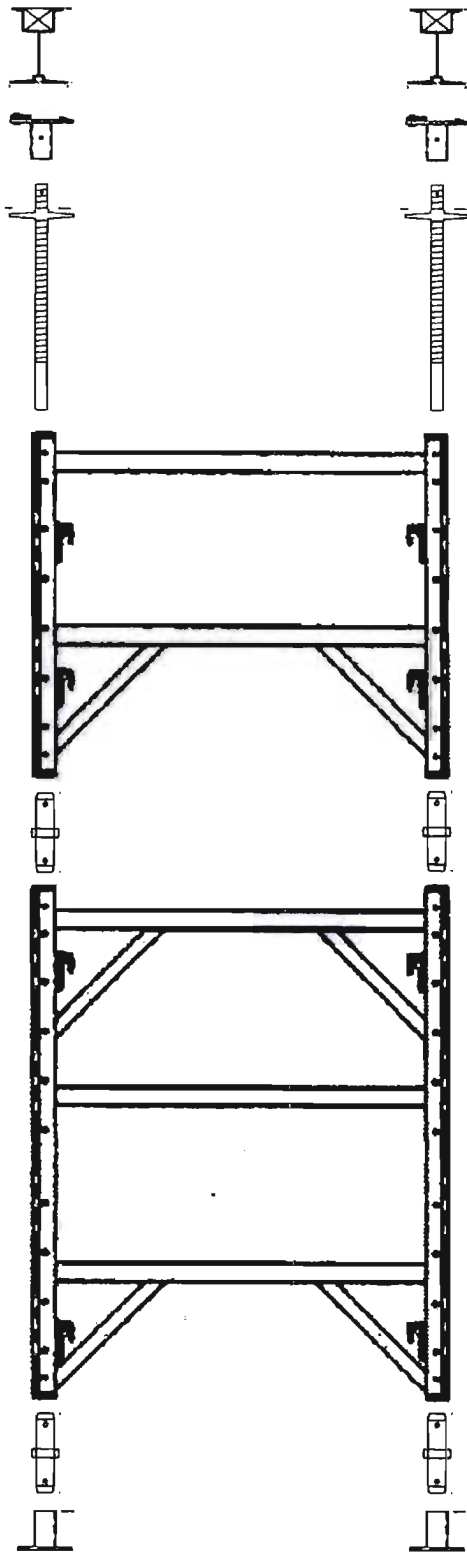

SH 40128  
 Broken Piece  
 Zone 40G

Folder: 08-02-20; SH



SH40128\_2



SH40128\_3



SH40128\_4



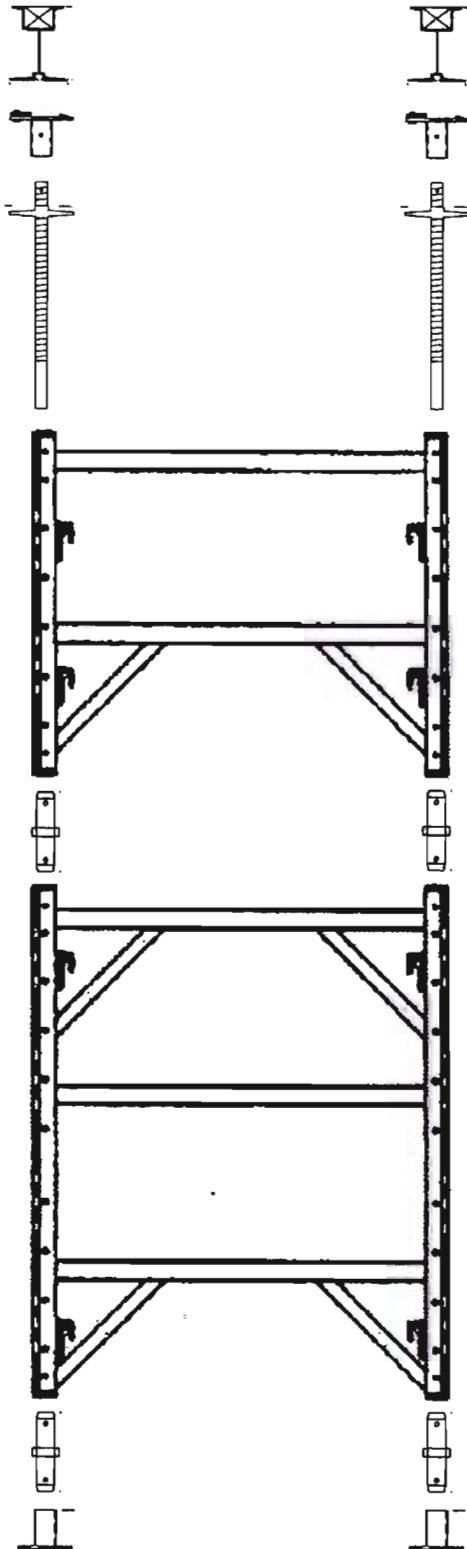

SH 40129  
Top plate  
Zone 40F

Folder: 08-02-20; 08-02-20; SH



SH40129\_1



SH40129\_2

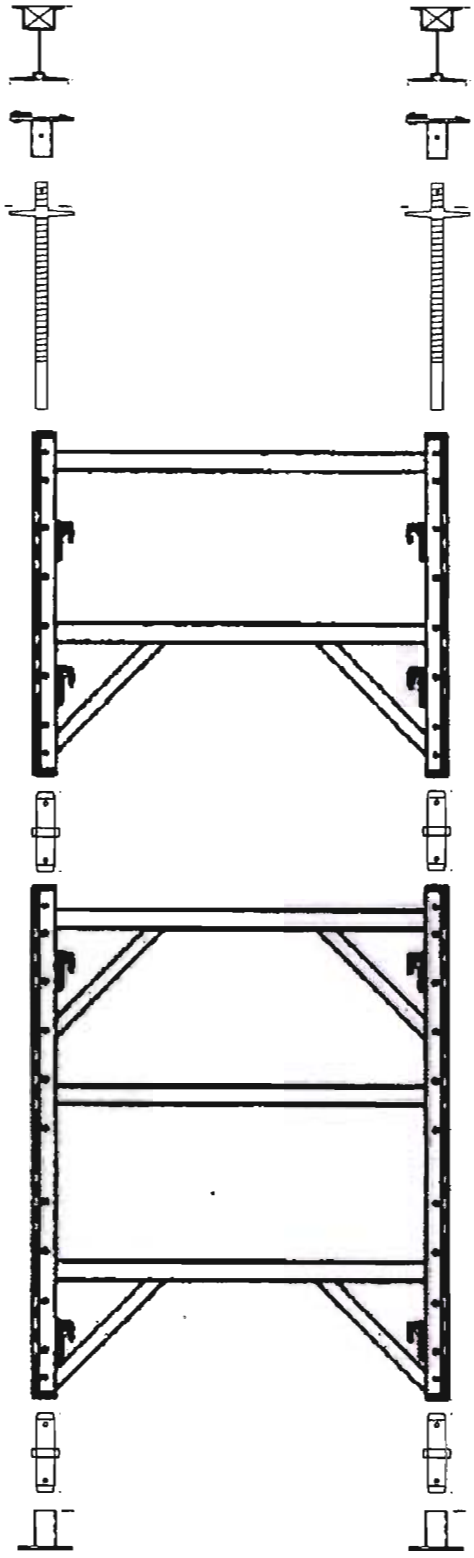

SH 40130  
Top plate  
Zone 40F

Folder: 08-02-20; SH 40130



SH40130\_1



SH40130\_2

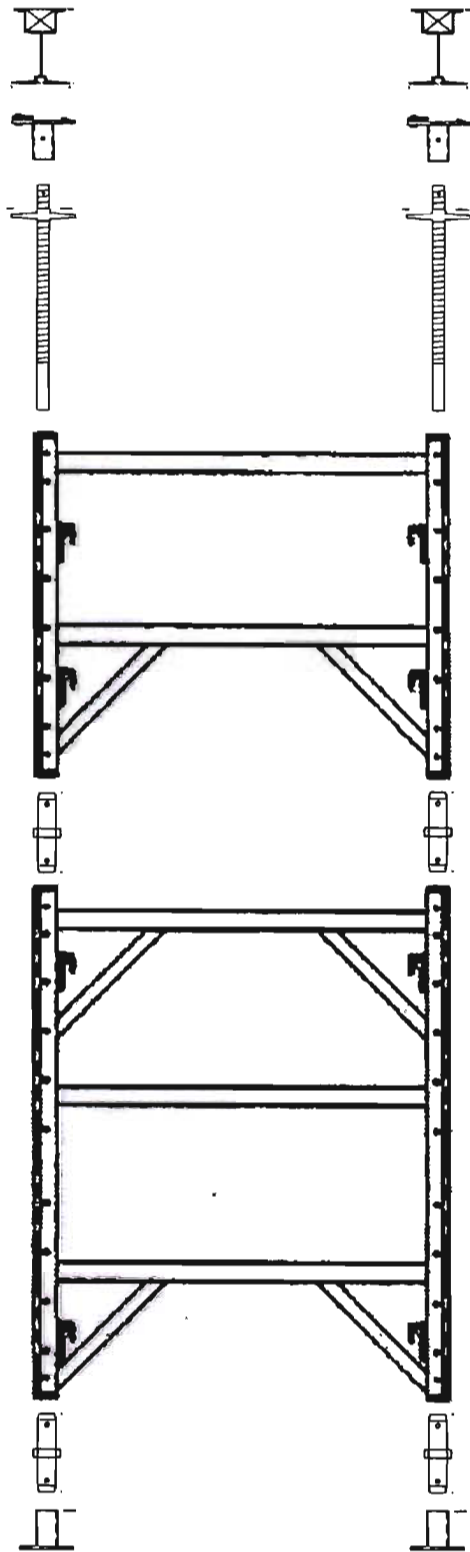

SH 40131  
 Top plate  
 Zone 40F

Folder: 08-02-20; SH 40131



SH40131\_1



SH40131\_2



SH40131\_3

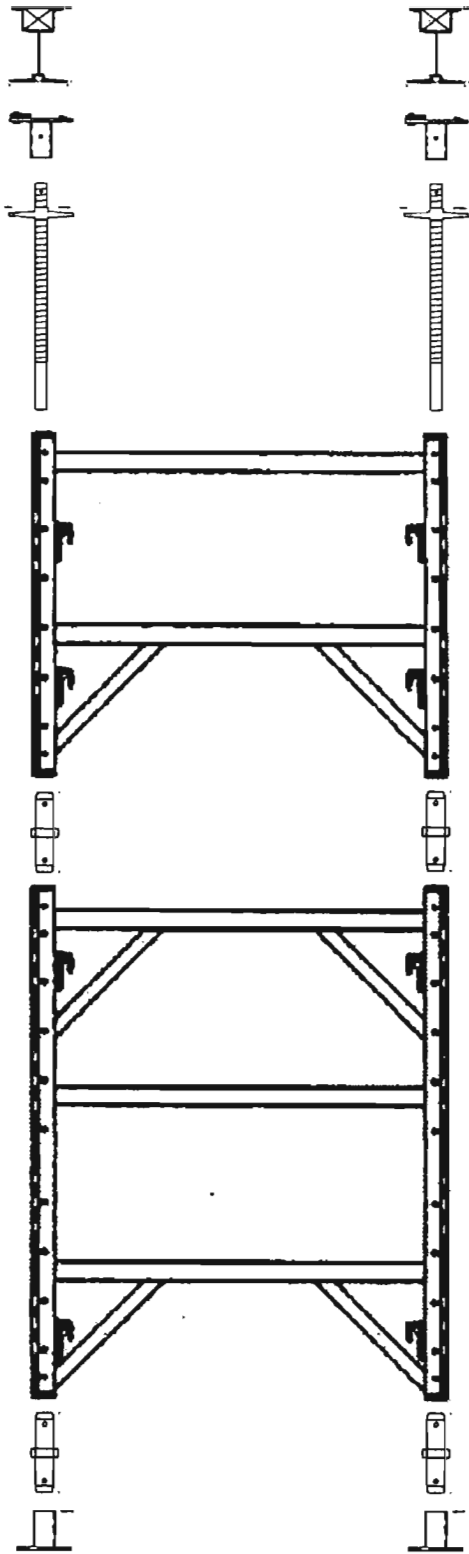

SH 40132  
 Clip  
 Zone 40G

Folder: 08-02-21; SH 40132



SH40132\_1



SH40132\_2



SH40132\_3



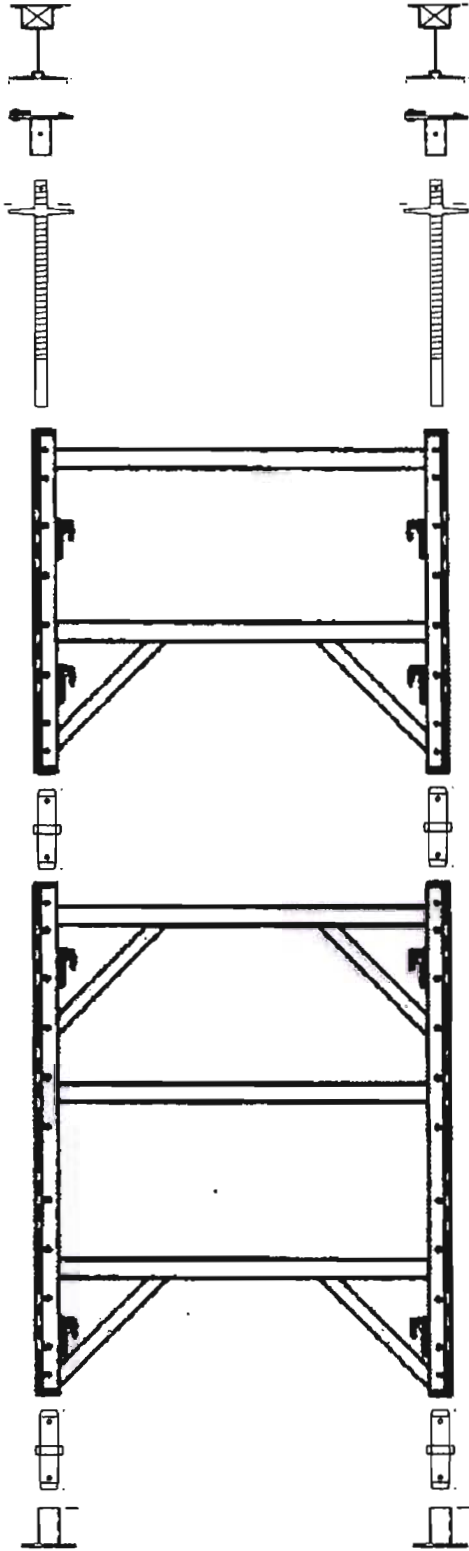

SH 40133 Frame Piece Near SH 40124

Folder: 08-02-21; SH 40133



SH40133\_1



SH40133\_3

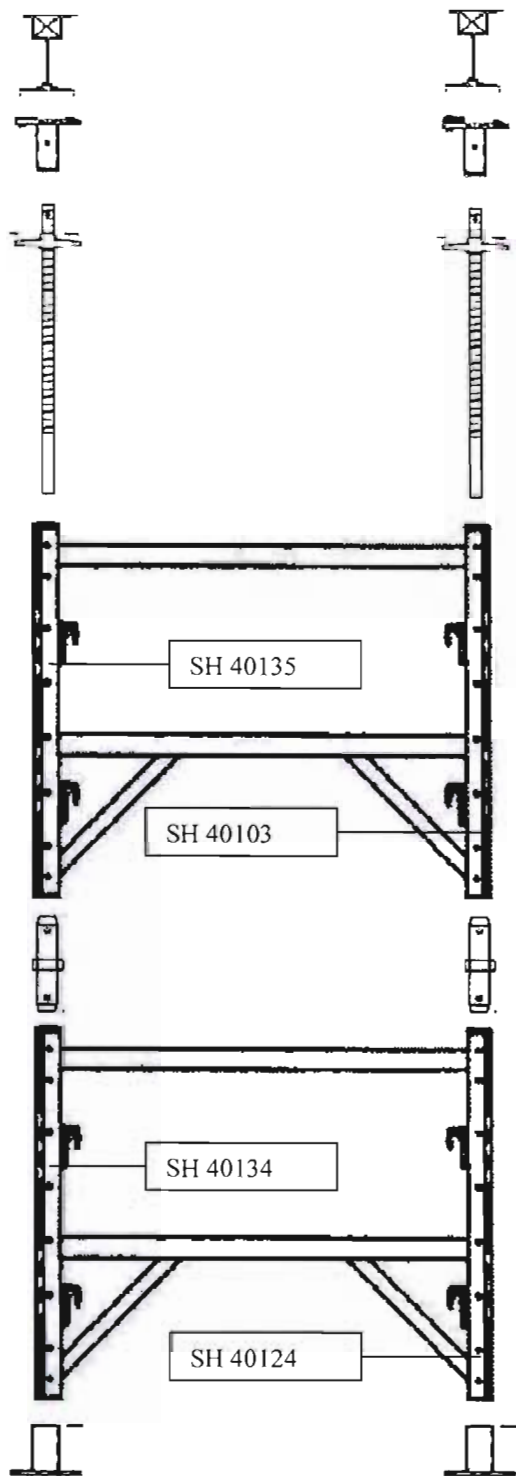

SH 40134  
 Frame buried in Concrete  
 Bottom Frame of SH 135  
 Zone 40G

Folder: 08-02-25 SH 40134



SH 40134\_1

SH 40135  
Frame buried in Concrete  
Zone 40G

Folder: 08-02-25 SH 40135



SH 40135\_1

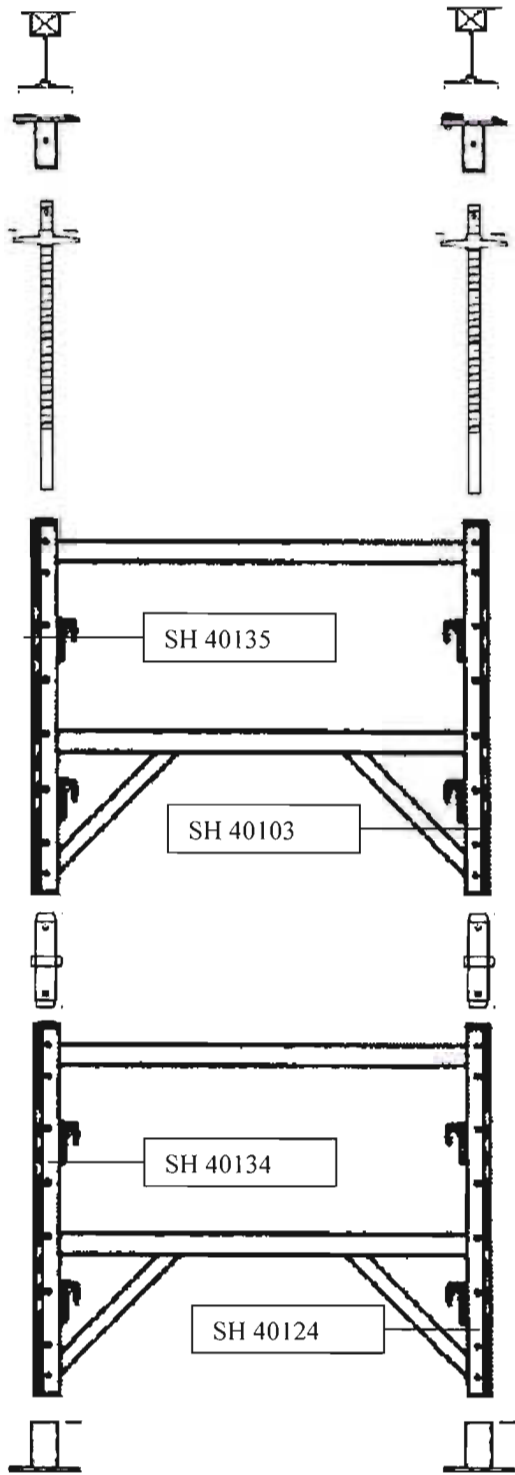

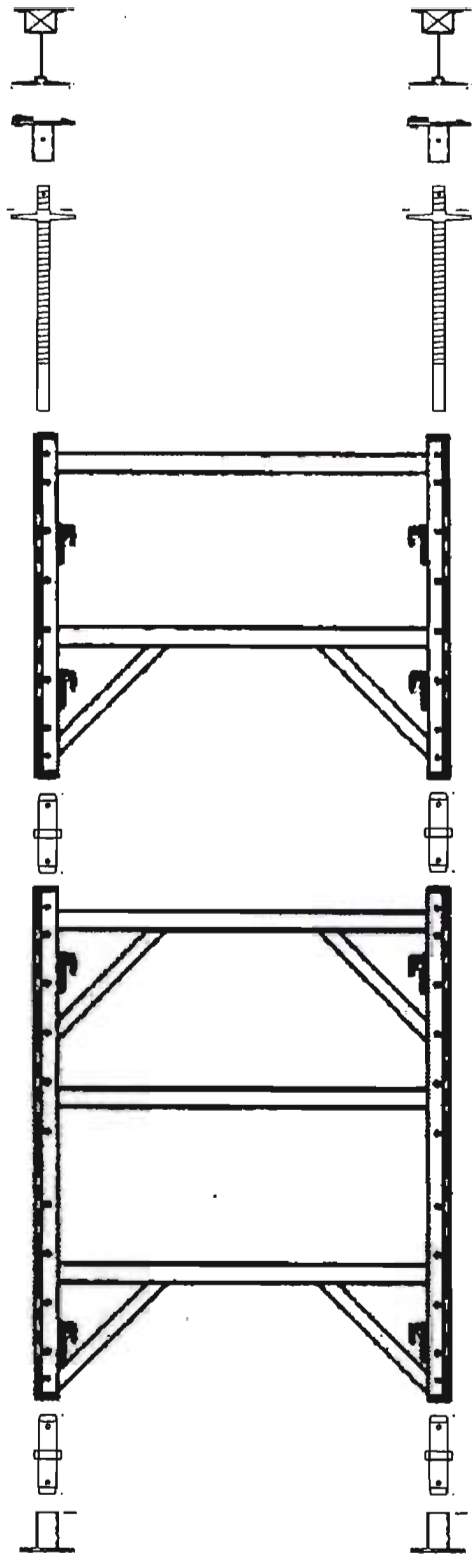

SH 40136  
 Brace  
 Zone 40G

Folder: 08-02-25 SH 40136

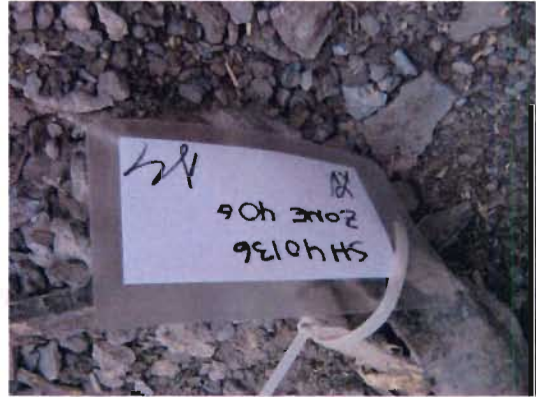

SH 40136\_1



SH 40136\_2



SH 40136\_4



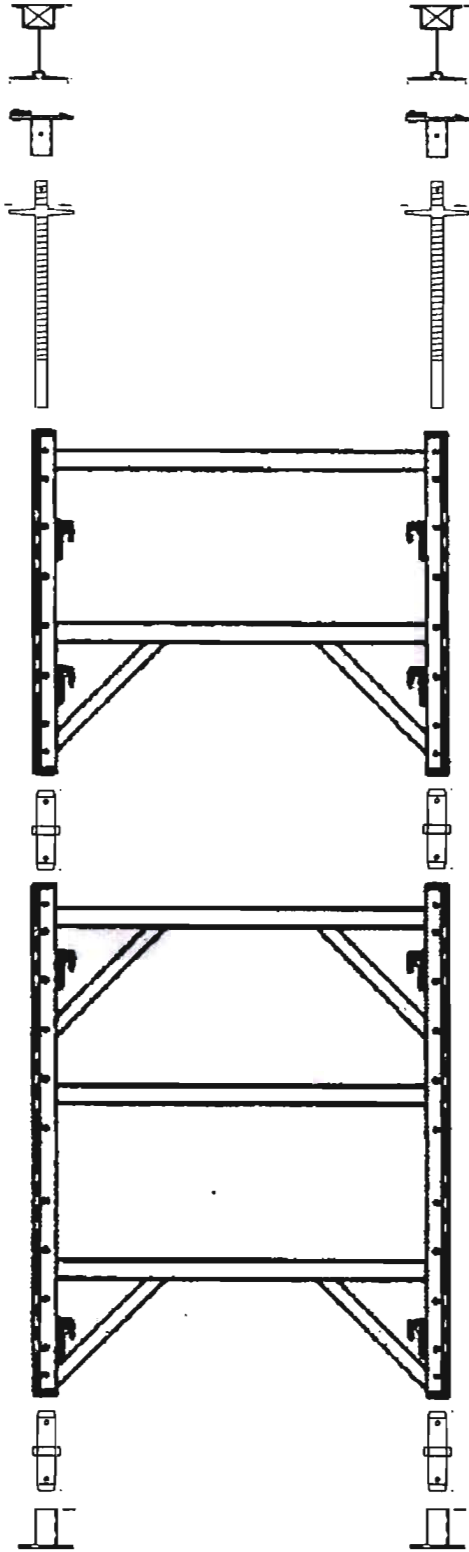

SH 40137  
 X Brace  
 Zone 40G

Folder: 08-02-20; SH 40137



SH40137\_1



SH40137\_2



SH40137\_3

SH 40138 on 41<sup>st</sup> floor  
Broken top frame of SH 40166  
Zone 40F

Folder: 08-02-20; SH 40138



SH40138\_1

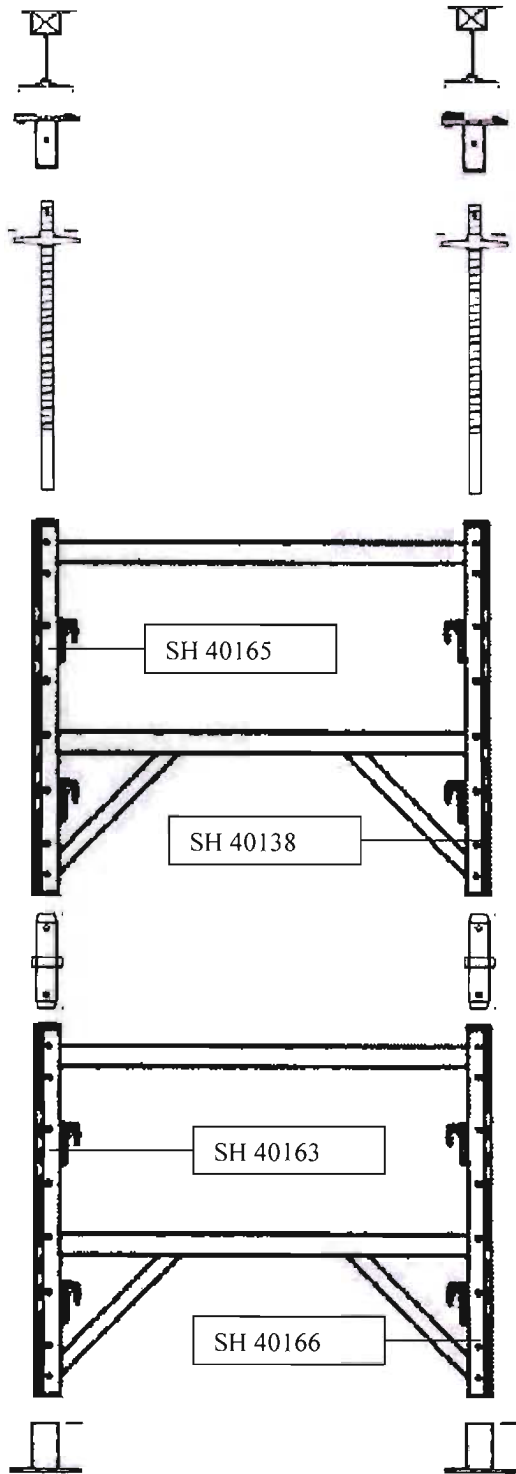

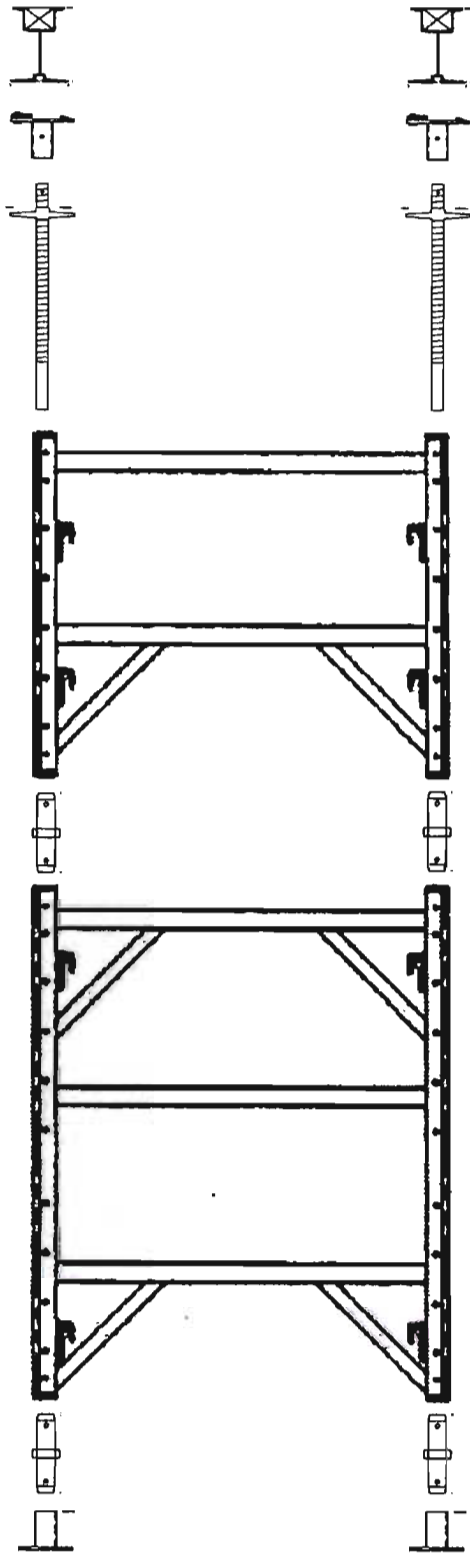

SH 40139  
 X Brace  
 Zone 40F

Folder: 08-02-20; SH 40139



SH40139\_1



SH40139\_2

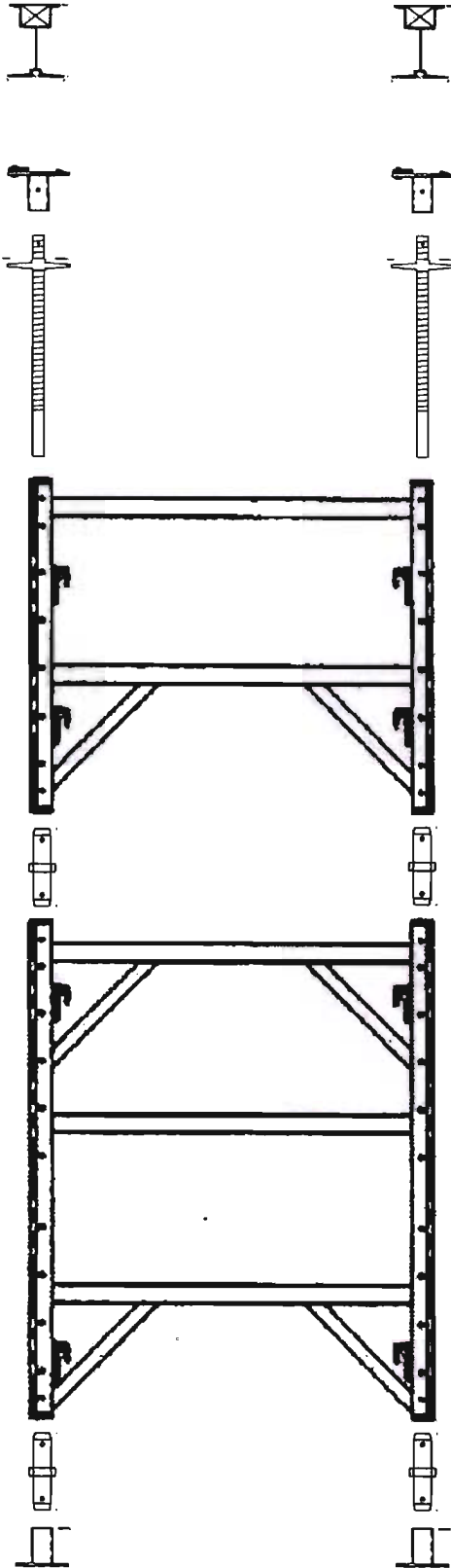

SH 40140  
 Top plate  
 Zone 40C

Folder: 08-02-25; 08-02-25; SH 40140



SH40140\_3



SH40140\_1



SH40140\_2



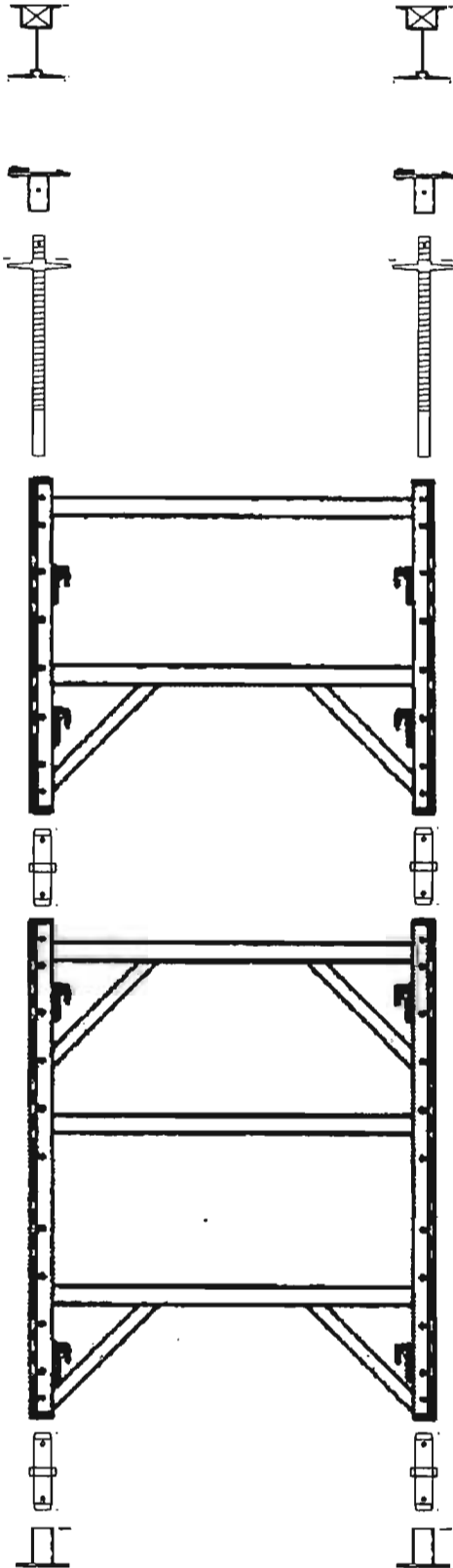

SH 40141  
 Brace  
 Zone 40G

Folder: 08-02-25; 08-02-25; SH 40141



SH40141\_1



SH40140\_2



SH40140\_3

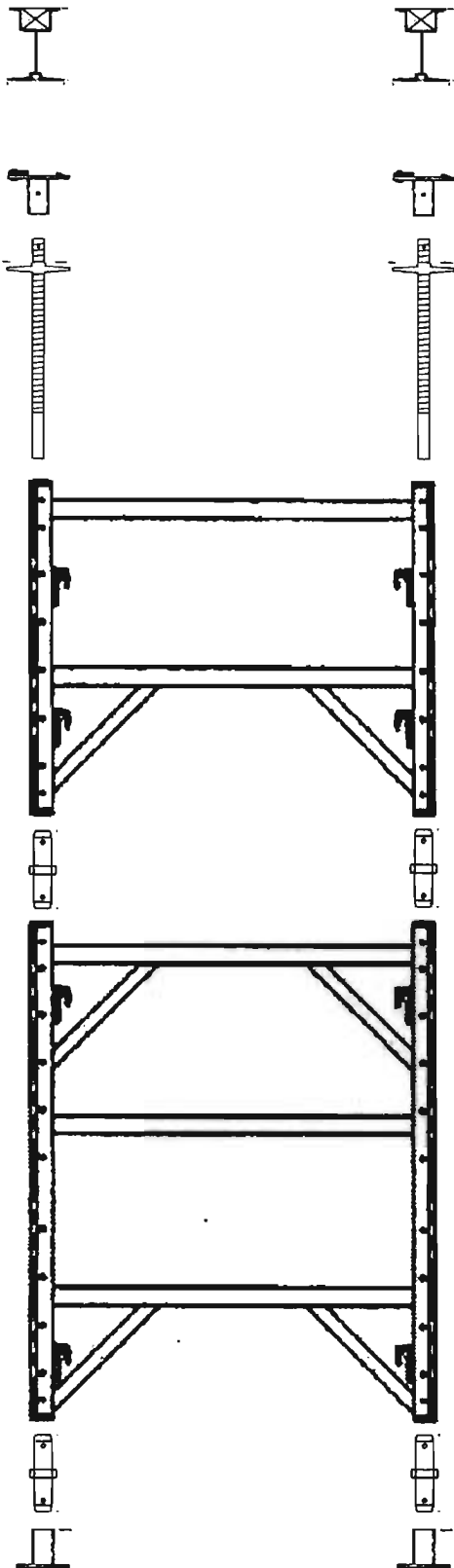

SH 40142  
 Bottom Plate  
 Moved from original position  
 Zone 40G-C

Folder: 08-02-26; SH 40142



SH40142\_1

Folder: 08-02-27; 08-02-27; SH

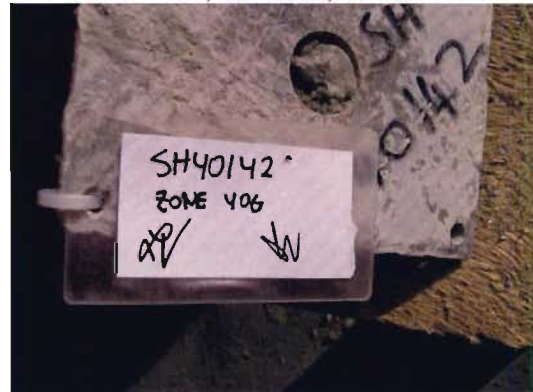

SH40142\_2



SH40142\_4

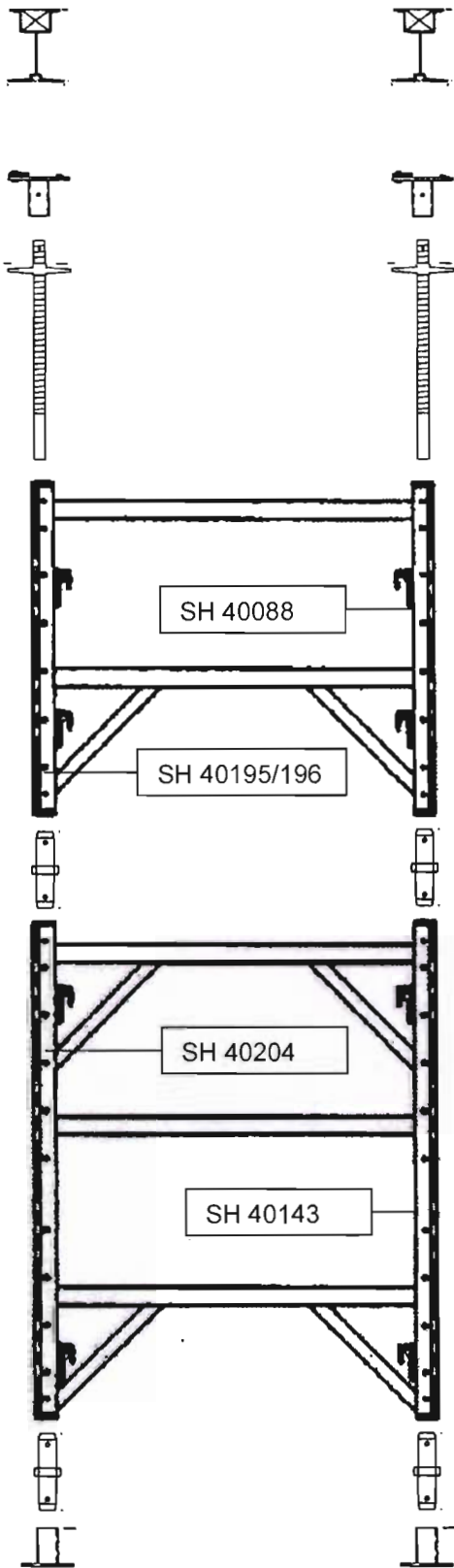

SH 40143  
Screw jack and Broken Bottom Frame  
Zone 40G-C

Folder: 08-02-26; 08-02-27 SH 40143





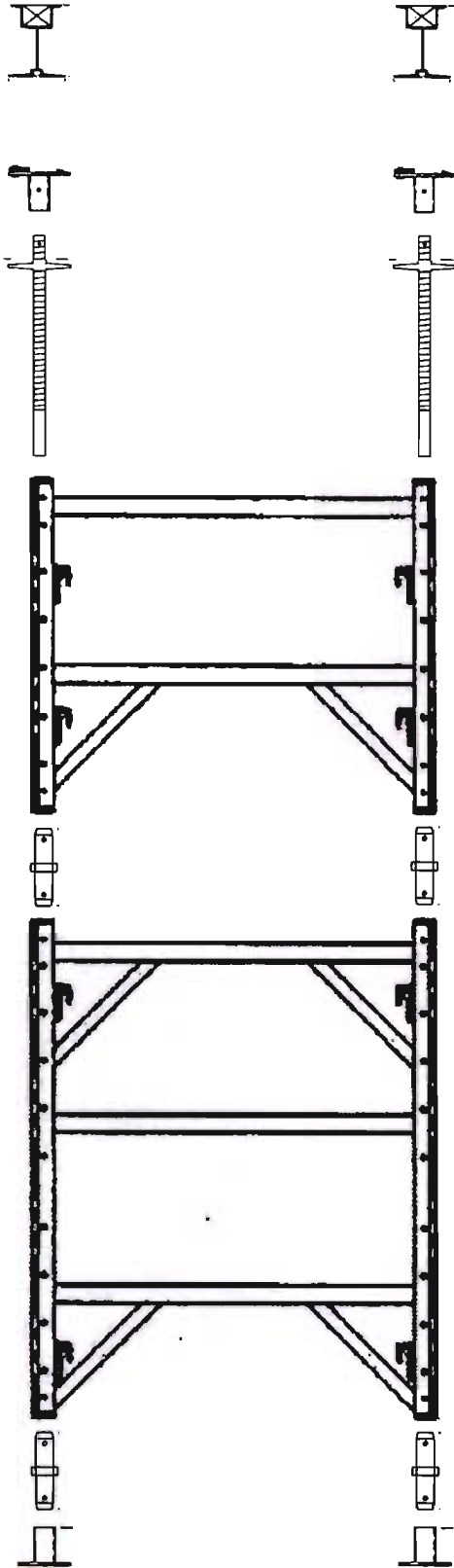

SH 40144  
 Clip  
 Zone 40G-C

Folder: 08-02-26; 08-02-27; SH 40144



SH40144\_2

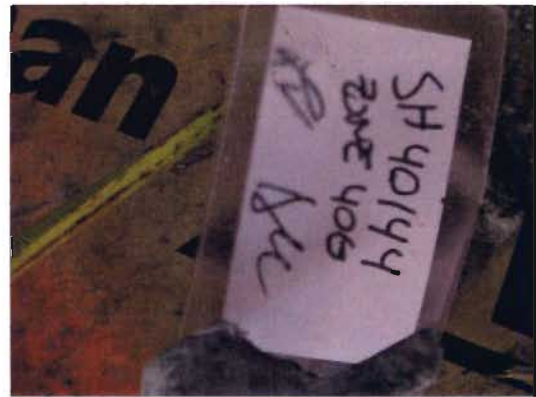

SH40144\_3



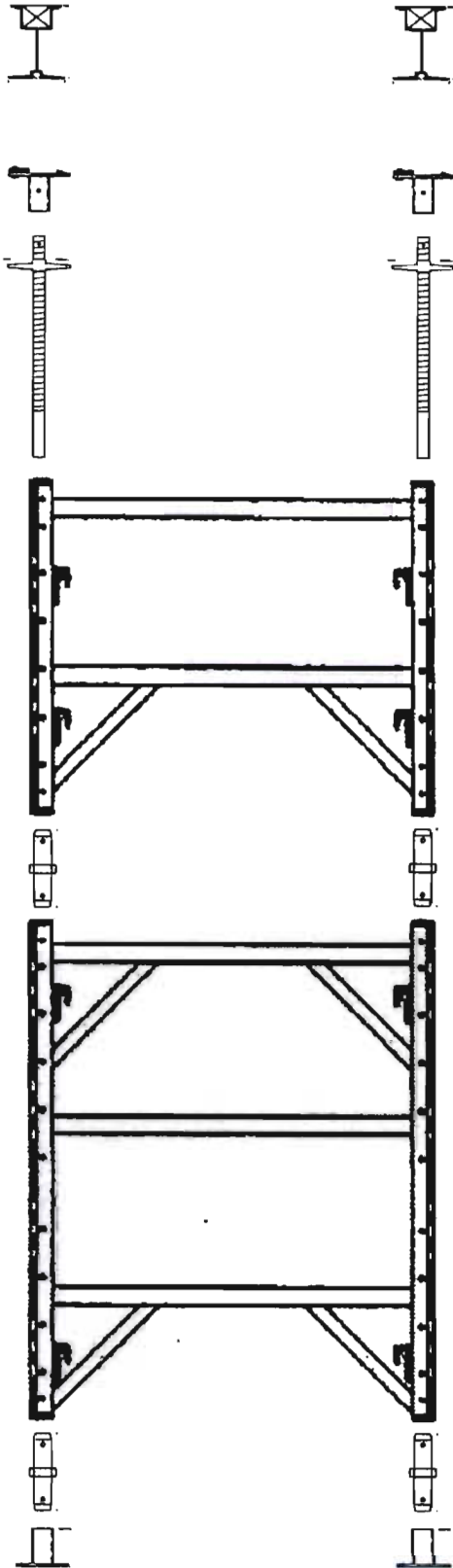

SH 40145  
 Broken piece of frame  
 Zone 40F

Folder: 08-02-26; 08-02-27; SH 40145



SH 40145\_1



SH40145\_2



SH40145\_3

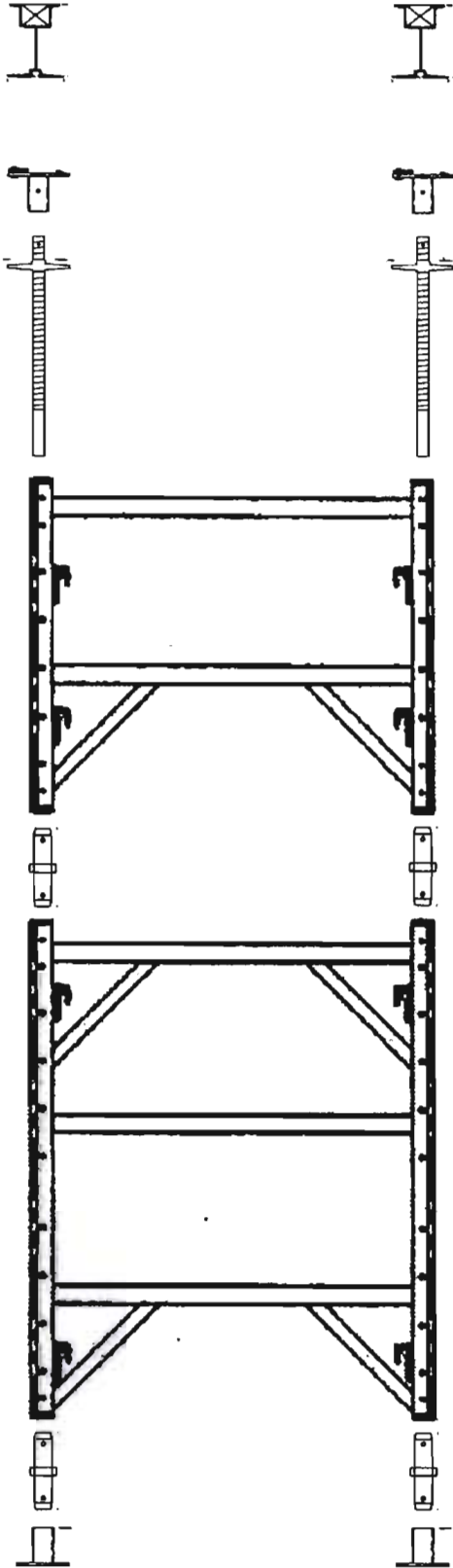

SH 40146  
 Broken piece of frame  
 Zone 40F

Folder: 08-02-26; 08-02-27; SH 40146



SH40146\_1



SH40146\_2



SH40146\_3



SH 40147  
Piece of frame  
Zone 40F



Folder: 08-02-26; 08-02-27; SH



SH40147\_1

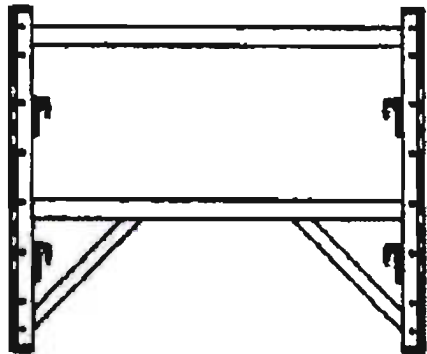

SH40147\_2



SH40147\_3

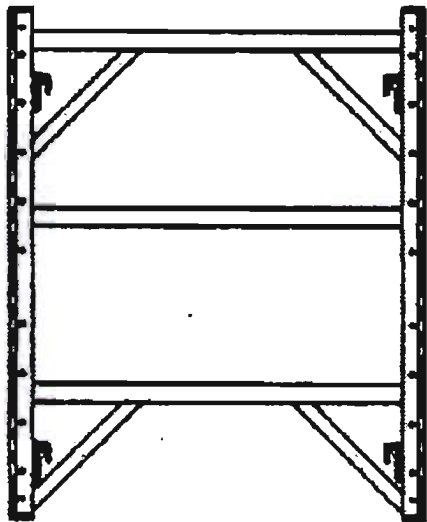



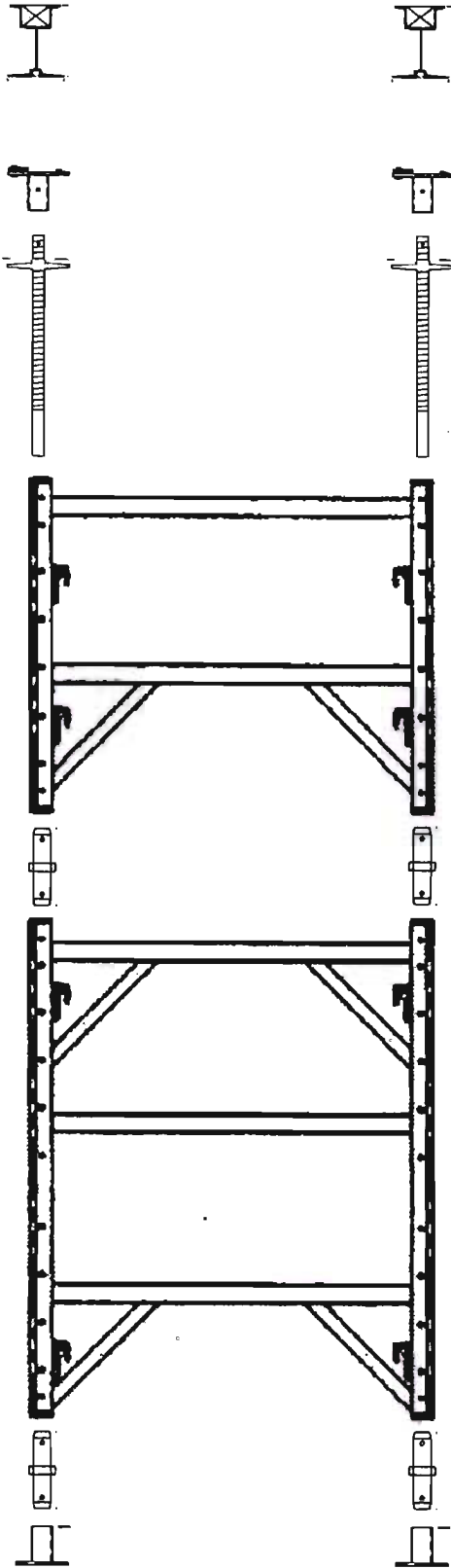

SH 40148  
 Piece of Frame  
 Zone 40F

Folder: 08-02-26; 08-02-27; SH 40148



SH40148\_2



SH40148\_1



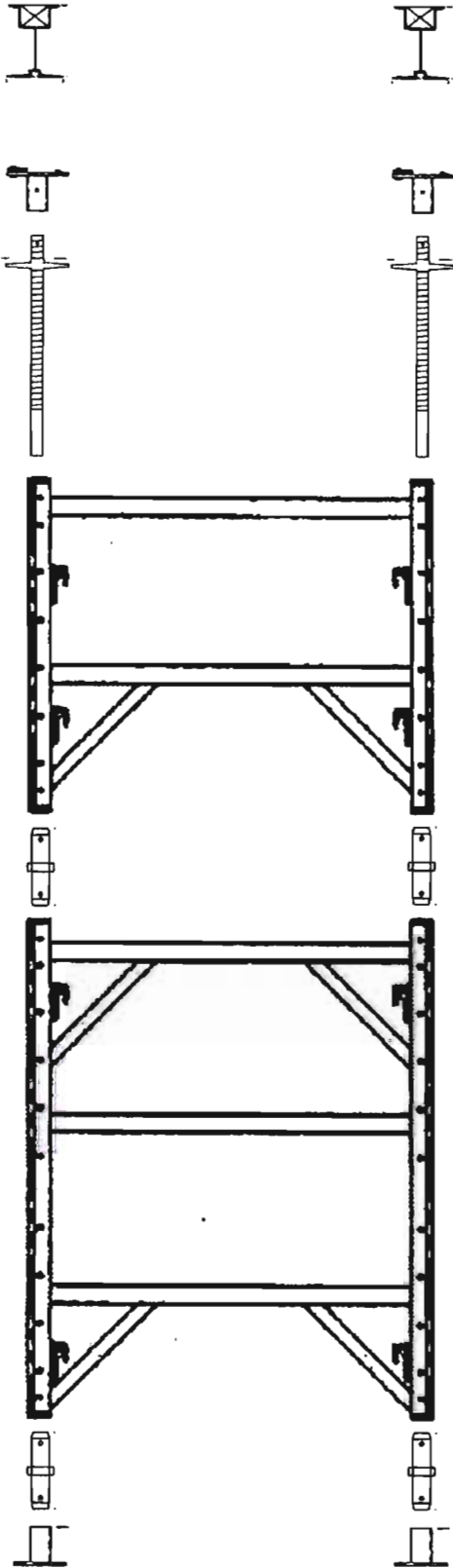

SH 40149  
 Broken piece of frame  
 Zone 40G

Folder: 08-02-26; 08-02-27; SH 40149



SH40149\_1



SH40149\_2



SH40149\_5

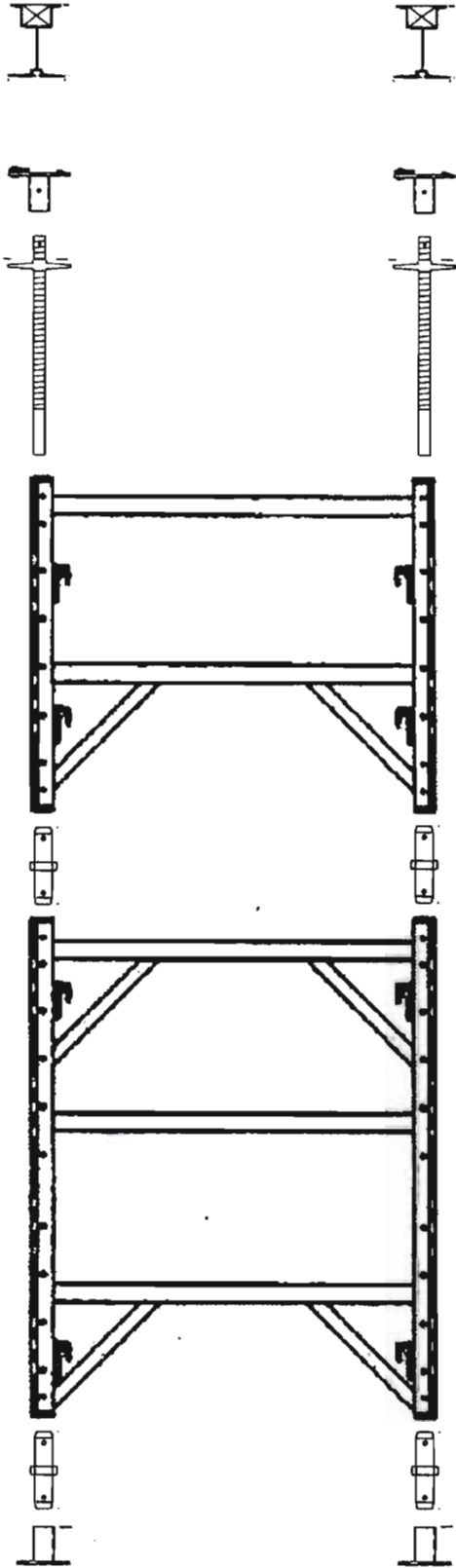

SH 40150  
Screw Jack  
Zone 40G

Folder: 08-02-26; 08-02-27; SH 40150



SH40150\_1



SH40150\_2

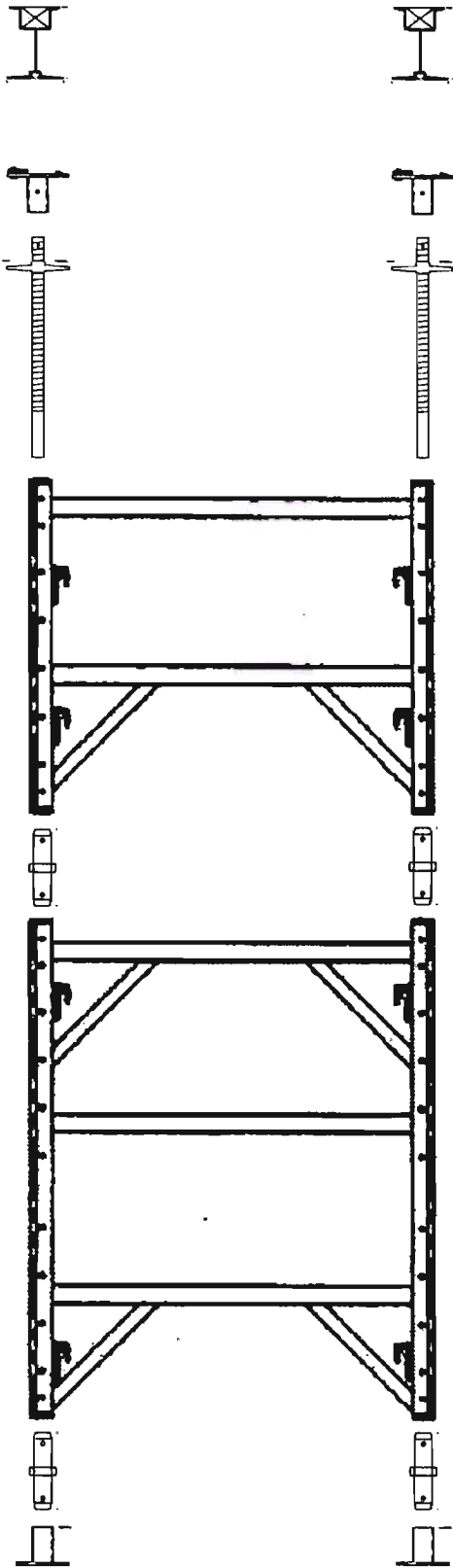

SH 40151  
Screw for Brace  
Zone 40G

Folder: 08-02-26; 08-02-27; SH 40151

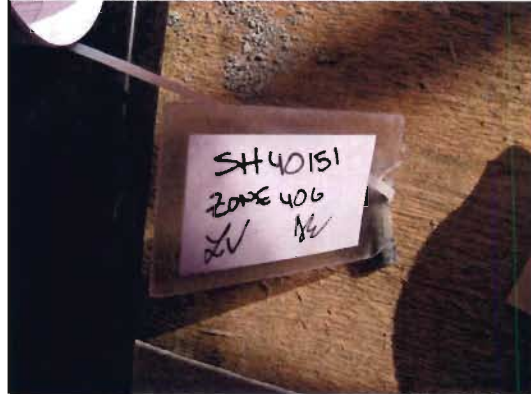

SH40151\_1

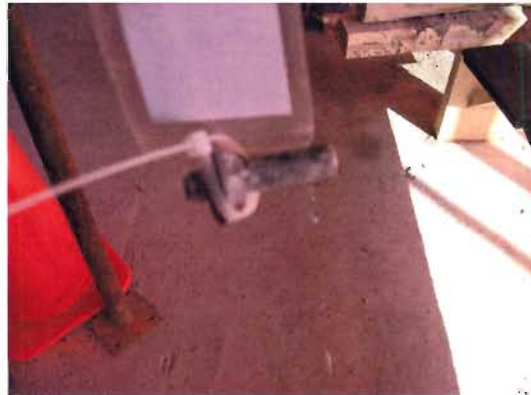

SH40151\_2

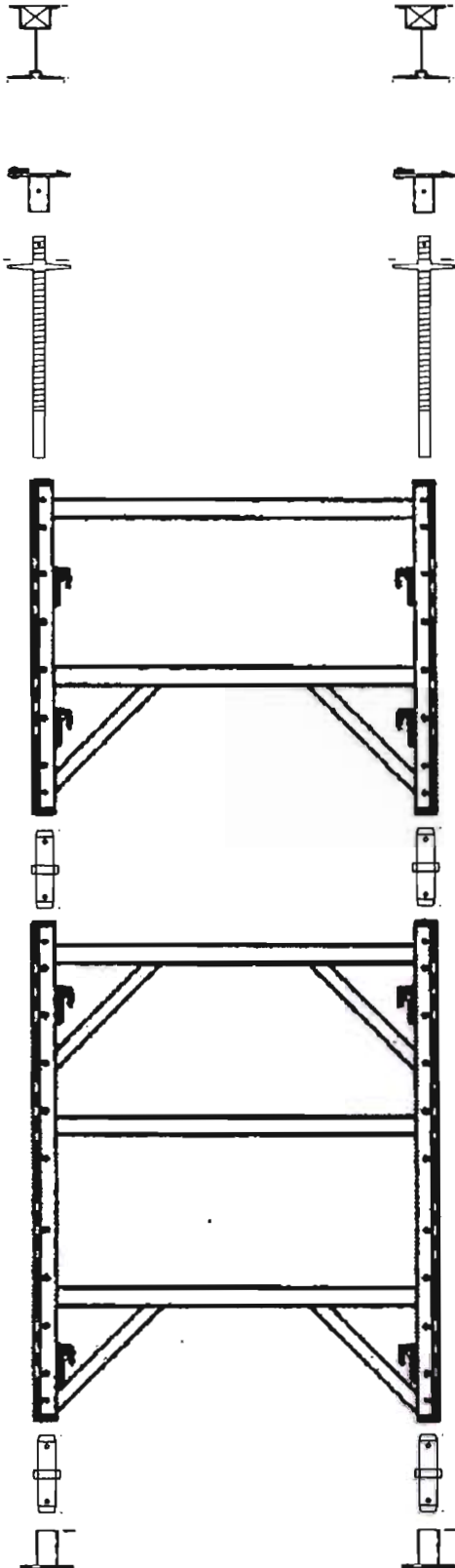

SH 40152  
 Bott Plate 3' East and 1' North of Col. 103  
 Zone 40G

Folder: 08-02-26; 08-02-27; SH 40152

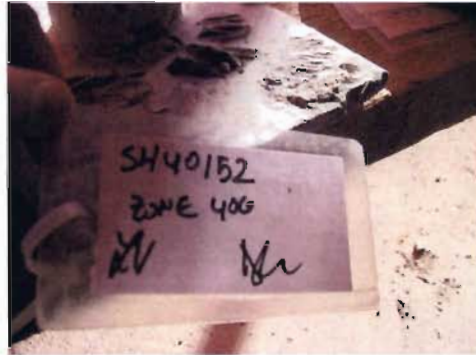

SH40152\_1



SH40152\_4



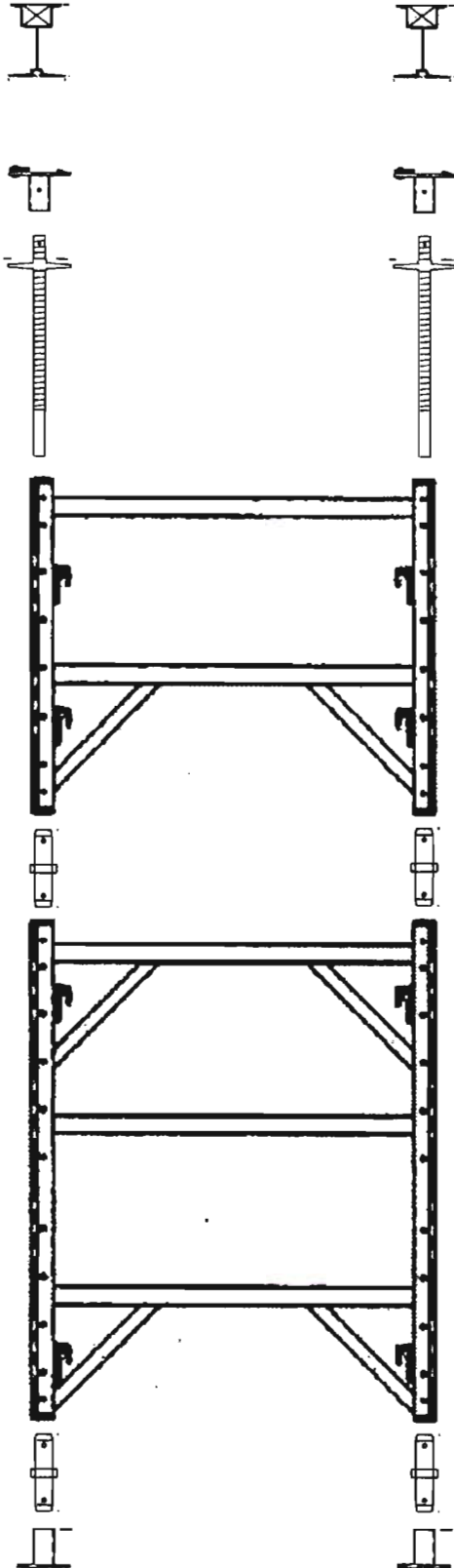

SH 40153  
 Brace  
 Zone 40G-C

Folder: 08-02-26; 08-02-27; SH 40153



SH40153\_3



SH40153\_1



SH40153\_2

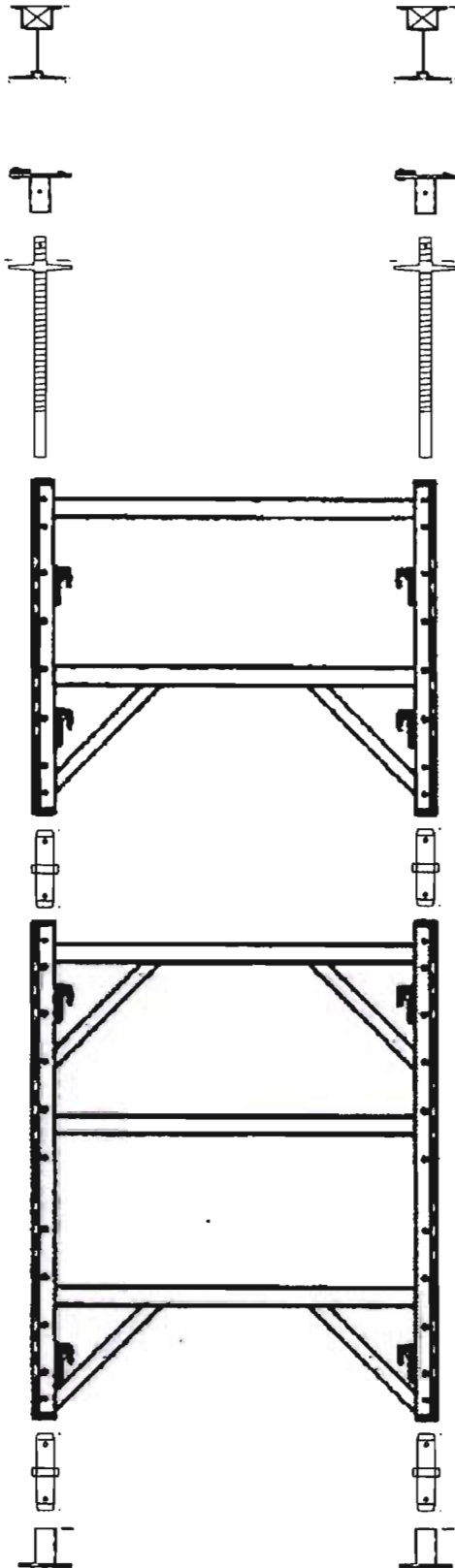

SH 40154  
 Bottom Brace  
 Zone 40B

Folder: 08-02-25; 08-02-27; SH 40154

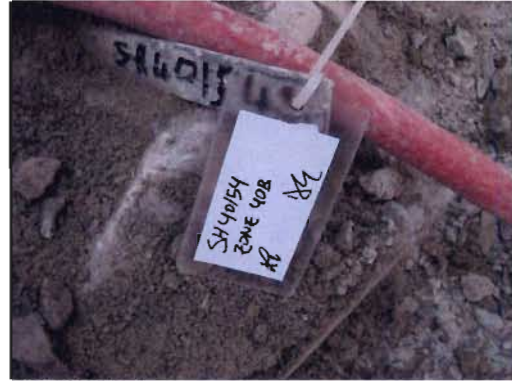

SH40154\_1



SH40154\_2



SH40154\_3

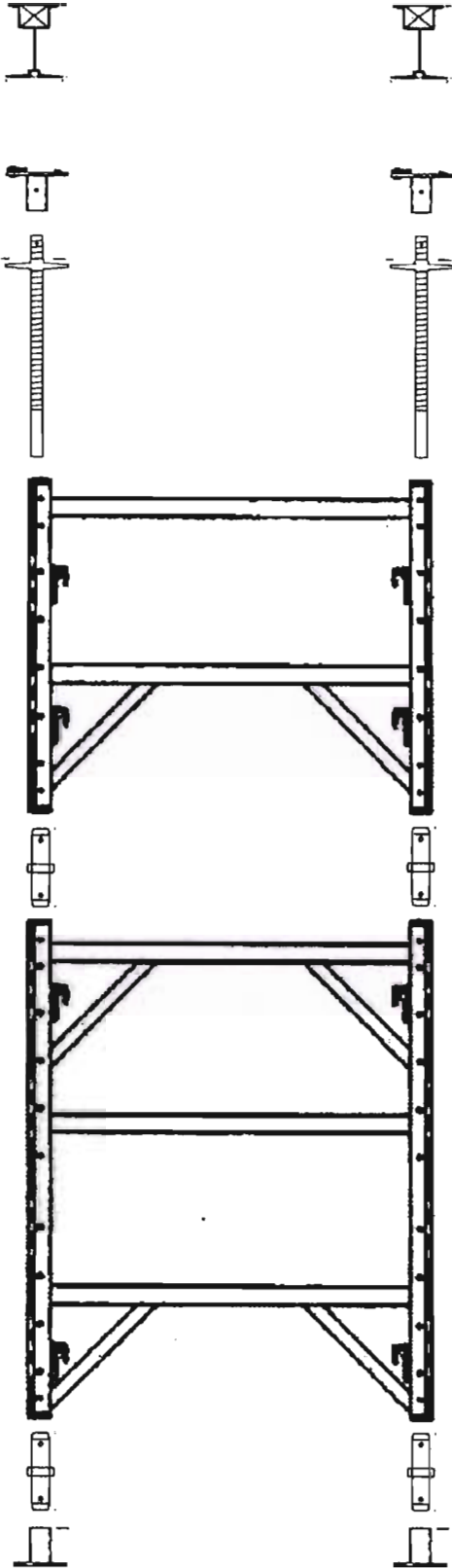

SH 40155  
Bracket  
Zone 40B

Folder: 08-02-25; 08-02-27; SH 40155



SH40155\_1



SH40155\_2



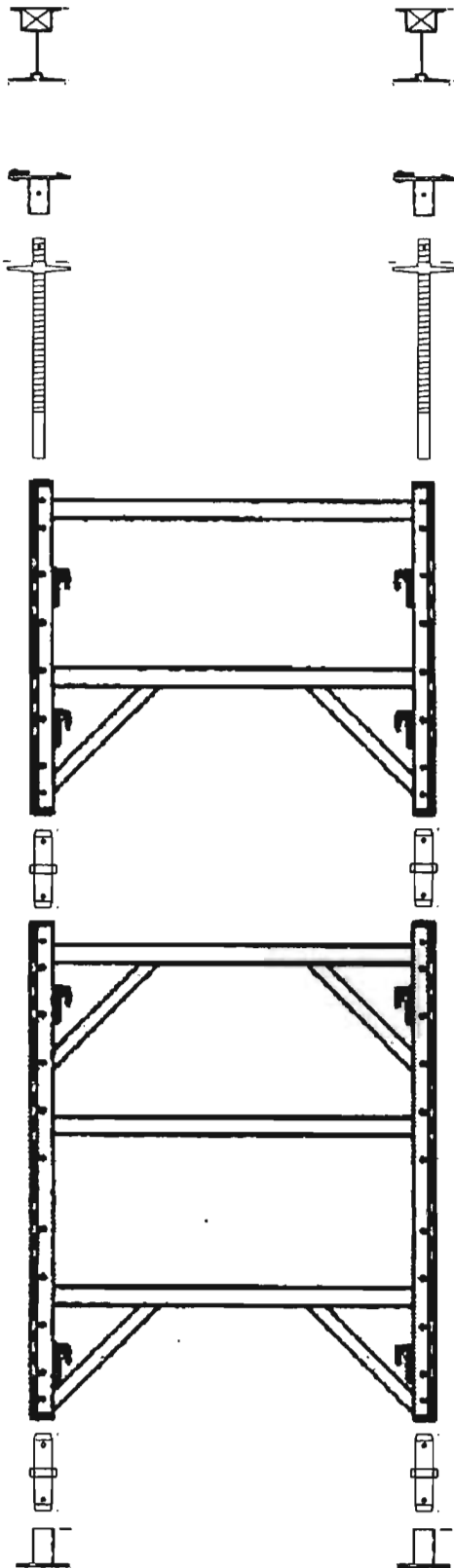

SH 40156  
 Screw for Brace  
 Zone 40B

Folder: 08-02-27; SH 40156



SH40156\_1



SH40156\_2



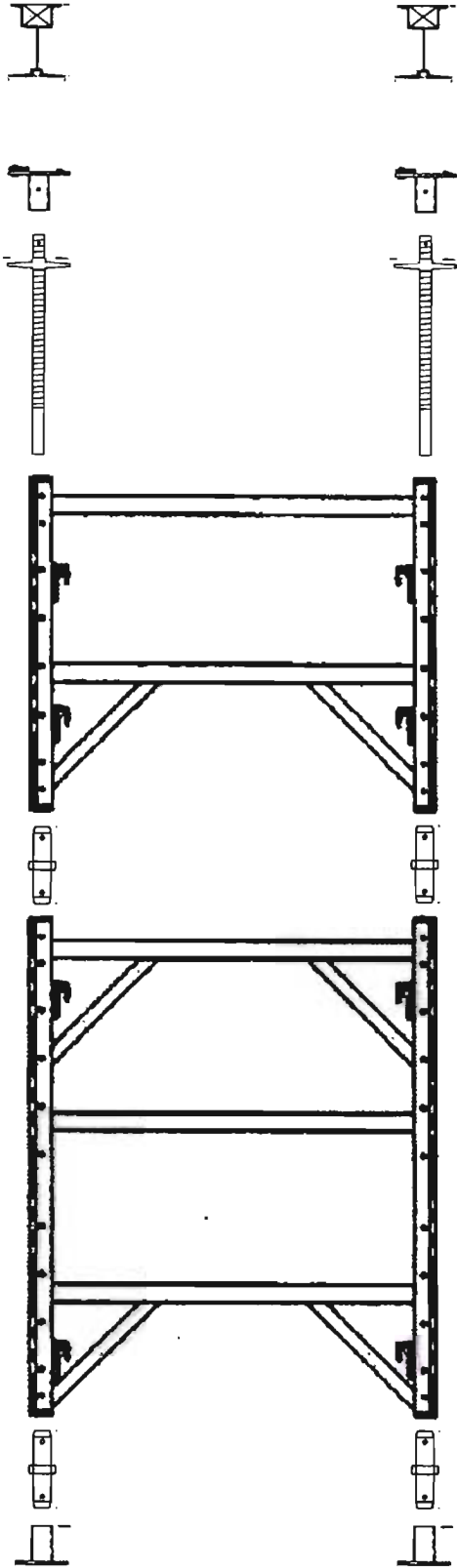

SH 40157  
 Broken piece of Frame  
 Zone 40G

Folder: 08-02-27; SH 40157



SH40157\_1



SH40157\_2



SH40157\_3

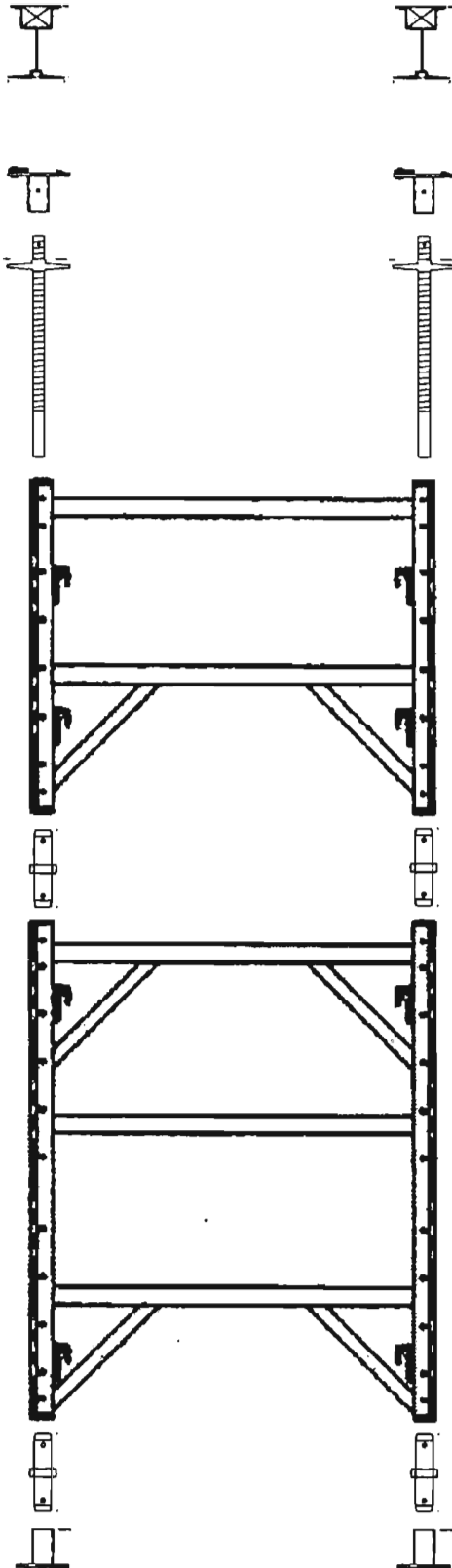

SH 40158  
Screw for brace  
Zone 40G

Folder: 08-02-27; 08-02-27; SH 40158



SH40158\_1



SH40158\_2



SH40158\_3

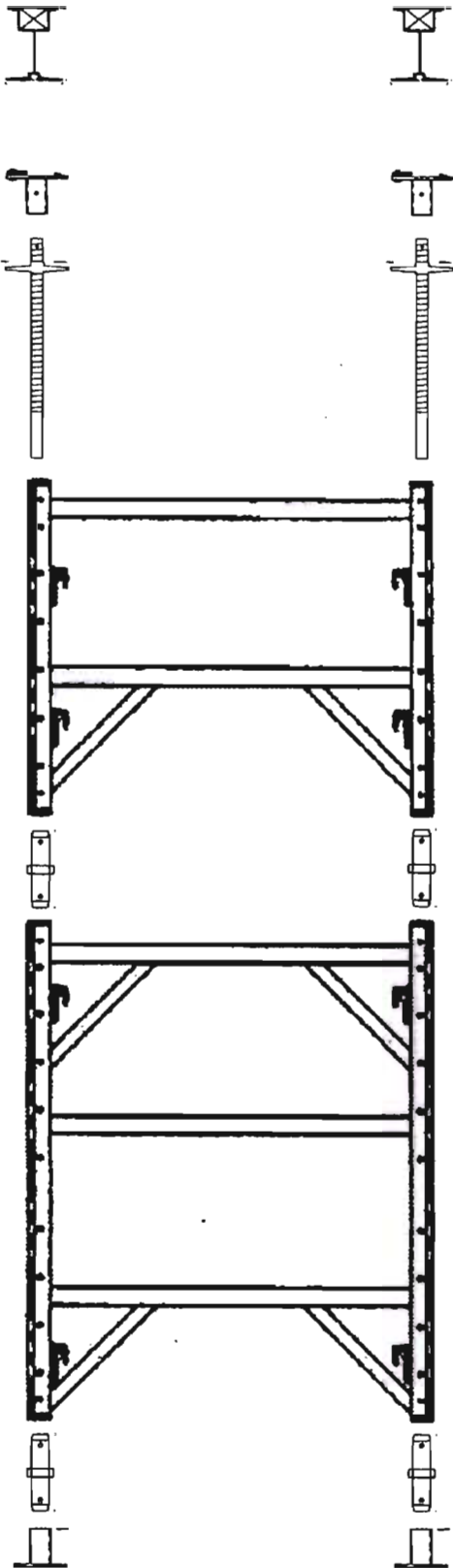

SH 40159  
Bracket  
Zone 40G

Folder: 08-02-27; 08-02-27; SH 40159

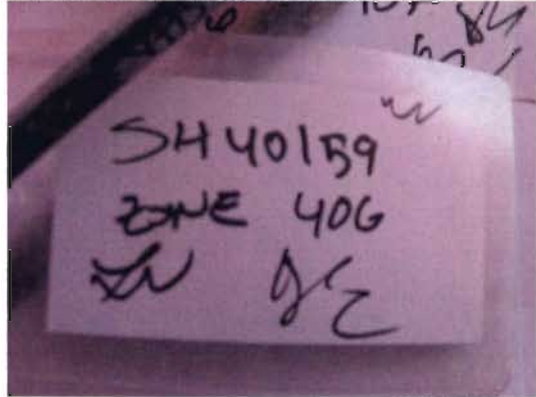

SH40159\_1

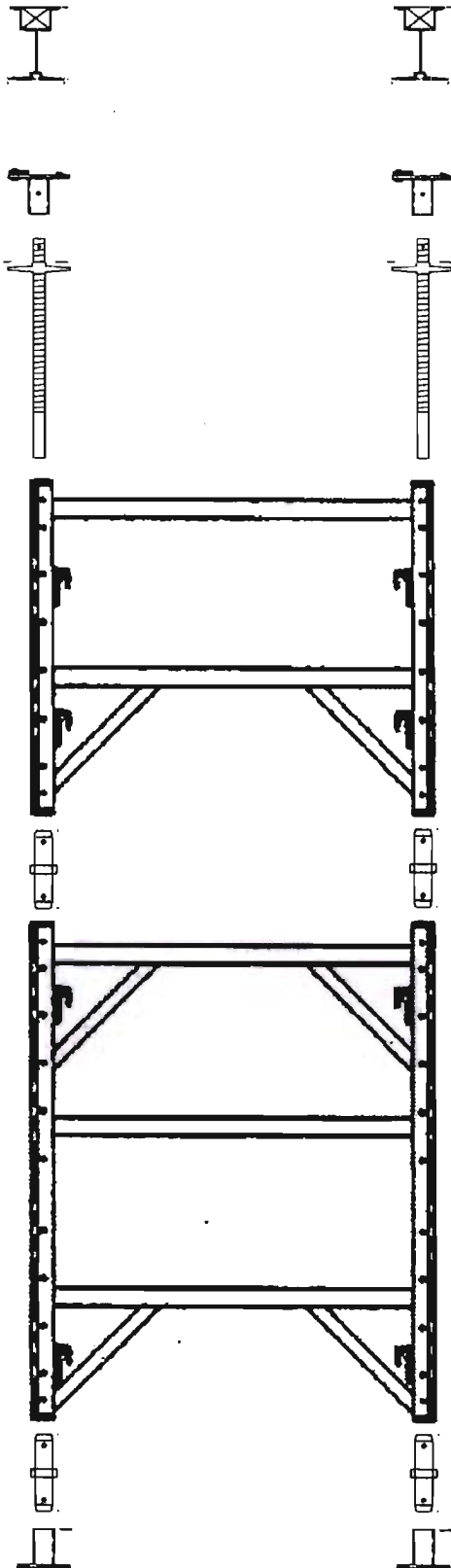

SH 40160  
 Brace  
 Zone 40G

Folder: 08-02-27; 08-02-27; SH 40160



SH40160\_1



SH40160\_2



SH40160\_3



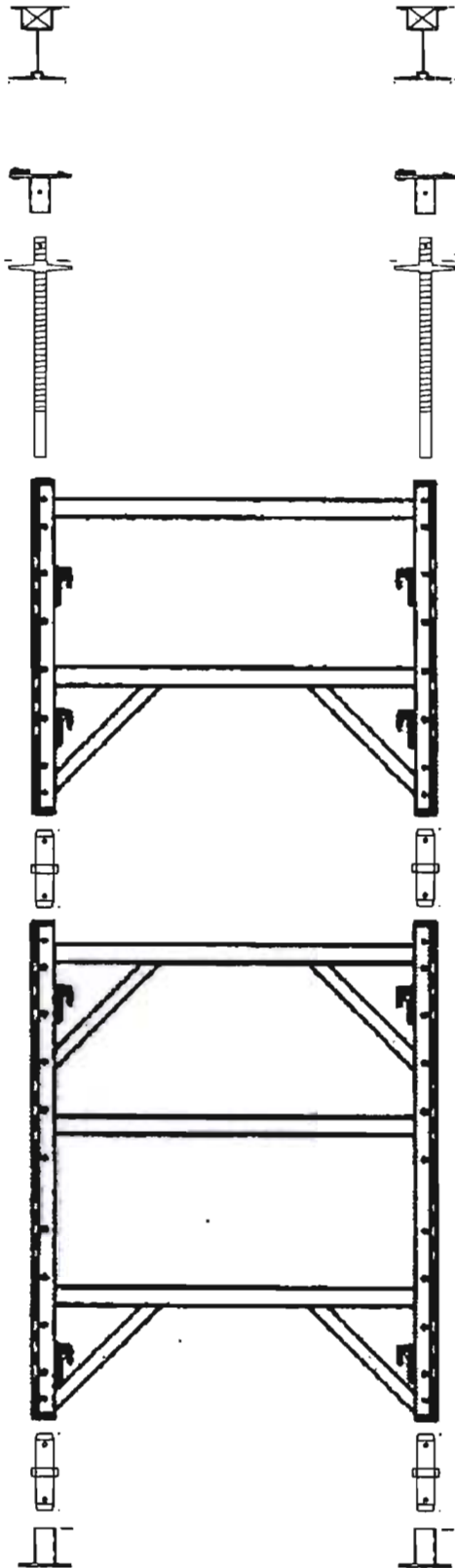

SH 40161  
 Top plate  
 Zone 40F

Folder: 08-02-27; 08-02-27; SH 40161



SH40161\_1



SH40161\_2



SH40161\_3

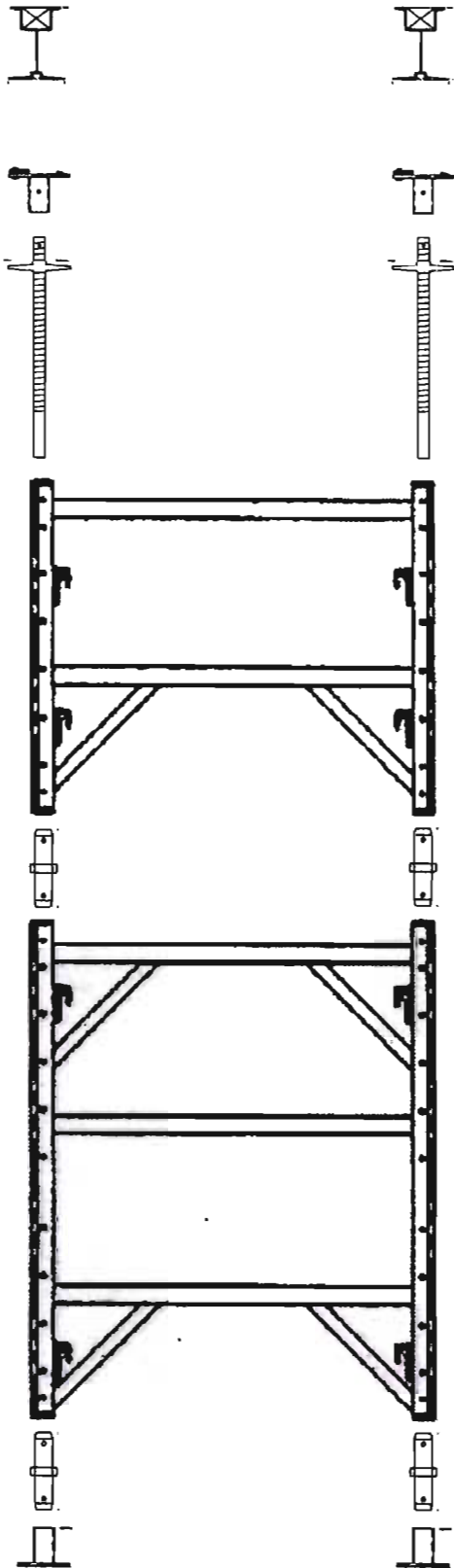

SH 40162  
 Top plate  
 Zone 40F

Folder: 08-02-27; 08-02-27; SH 40162

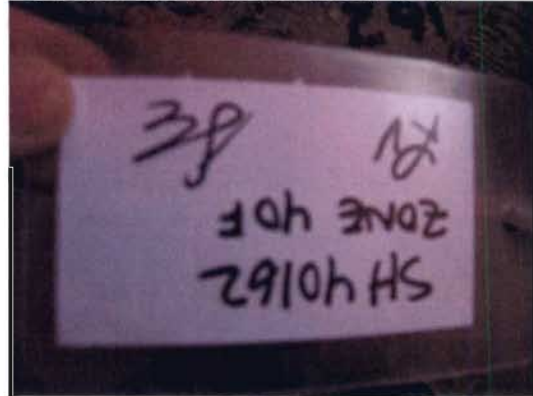

SH40162\_1

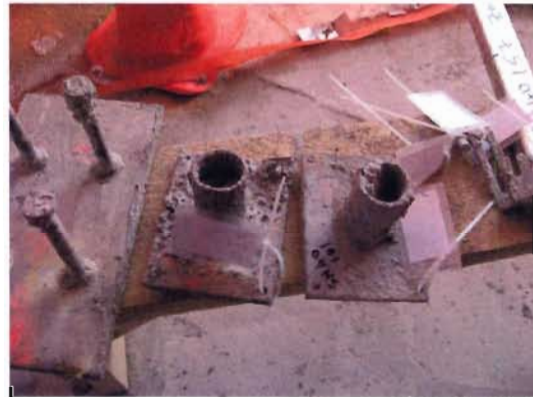

SH40162\_2



SH40162\_3

SH 40163 on 41<sup>st</sup> Floor  
Bott Frame of SH 40165  
Frame lying on Slab  
Zone 40G-C

Folder: 08-02-27; 08-02-27; SH 40163

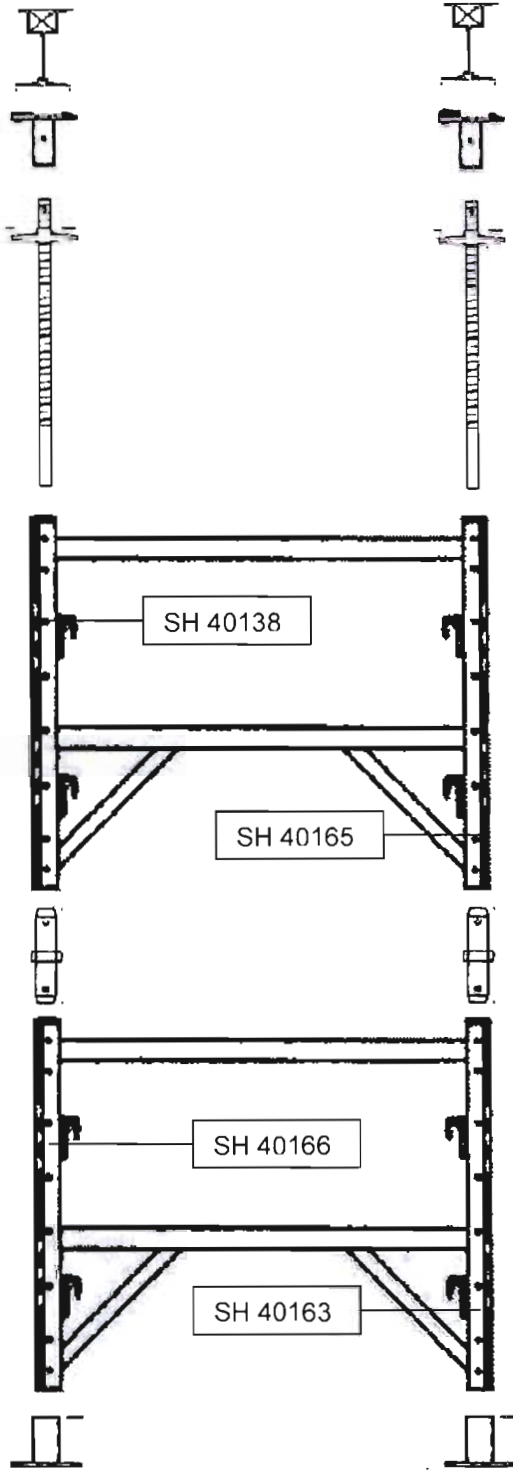

SH40163\_1



SH40163\_2



SH40163\_3



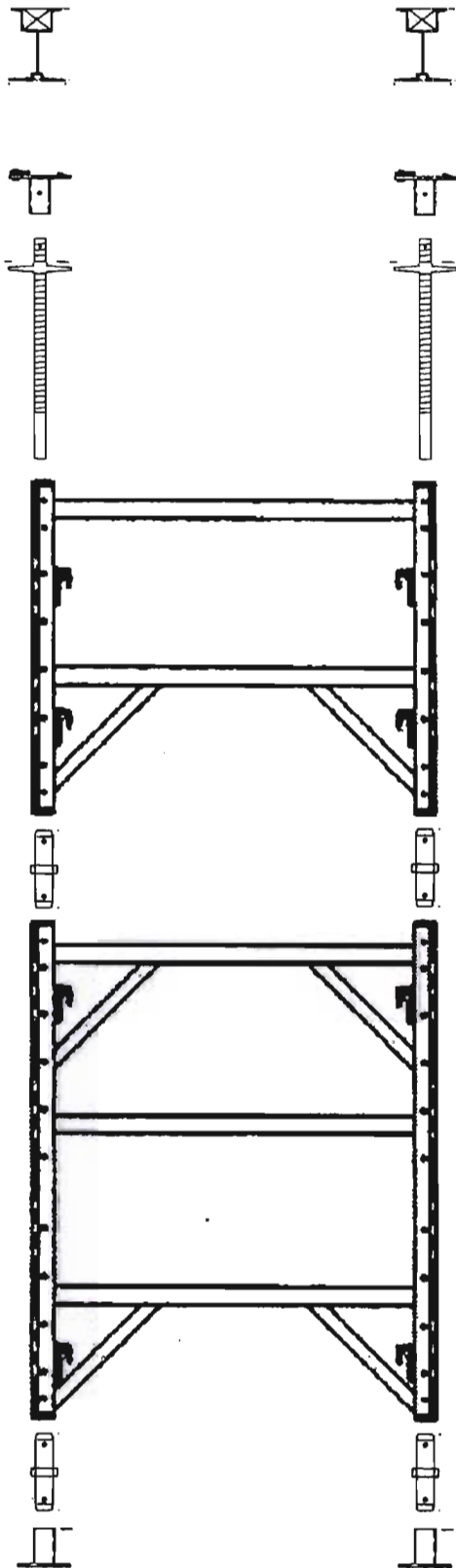

SH 40164  
Coupler  
Zone 40G

Folder: 08-02-27; 08-02-27; SH 40164

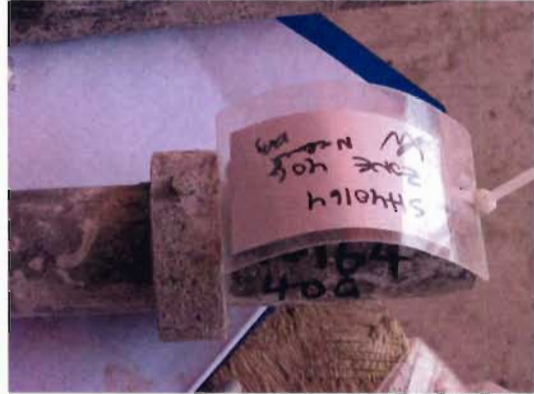

SH40164\_1



SH40164\_2



SH40164\_3



SH 40165 on 41<sup>st</sup> floor  
Top Frame 3'-6"  
Shoring tower frame is buried  
Zone 40G

Folder: 08-02-27; 08-02-27; SH 40165

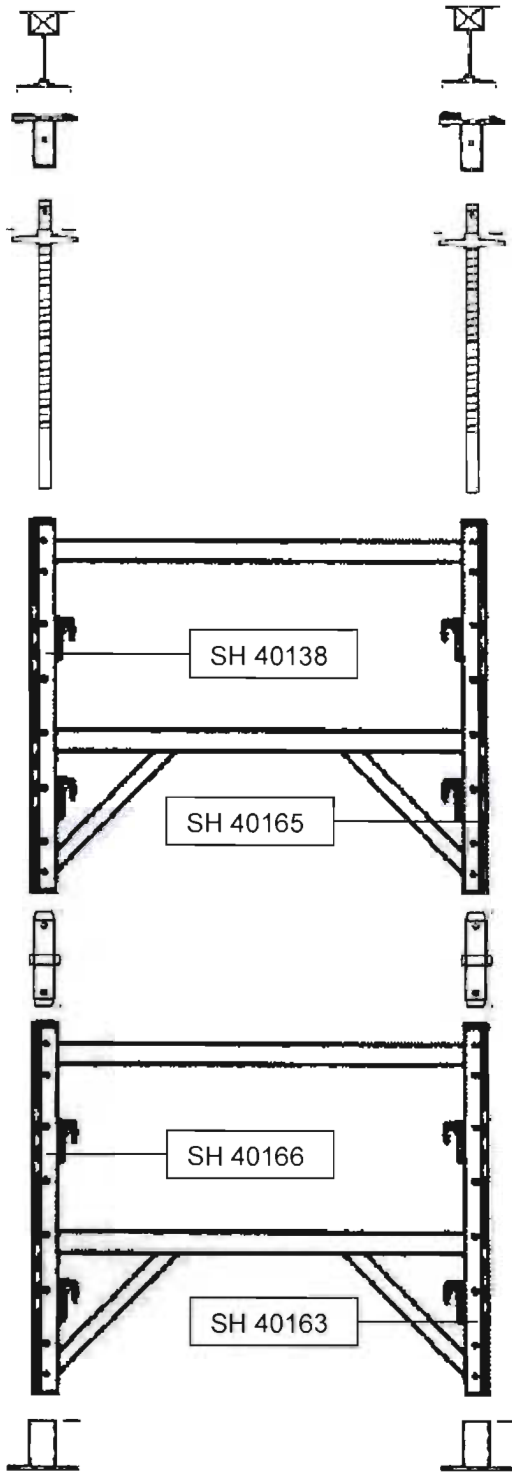

SH40165\_1



SH40165\_2



SH40165\_4

SH 40166  
Bottom Frame lying on SH 40062  
Zone 40F

Folder: 08-02-27; 08-02-27; SH 40166

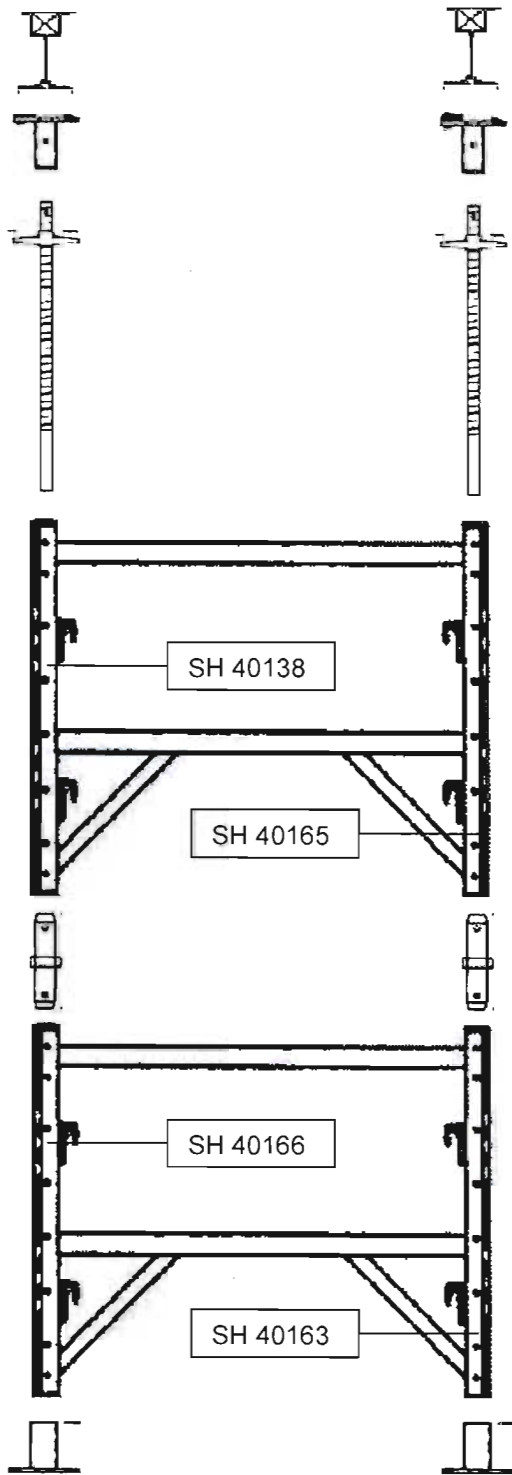

SH40166\_1



SH40166\_2



SH40166\_3

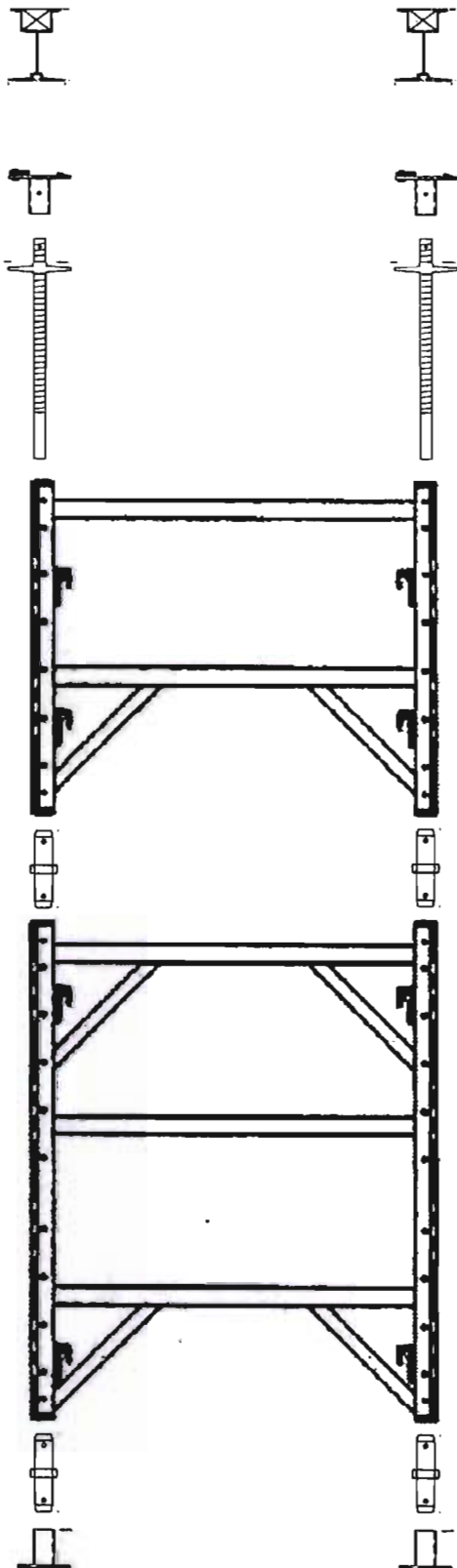

SH 40167  
 Brace  
 Zone 40G

Folder: 08-02-27; SH 40167



SH40167\_1



SH40167\_2



SH40167\_3



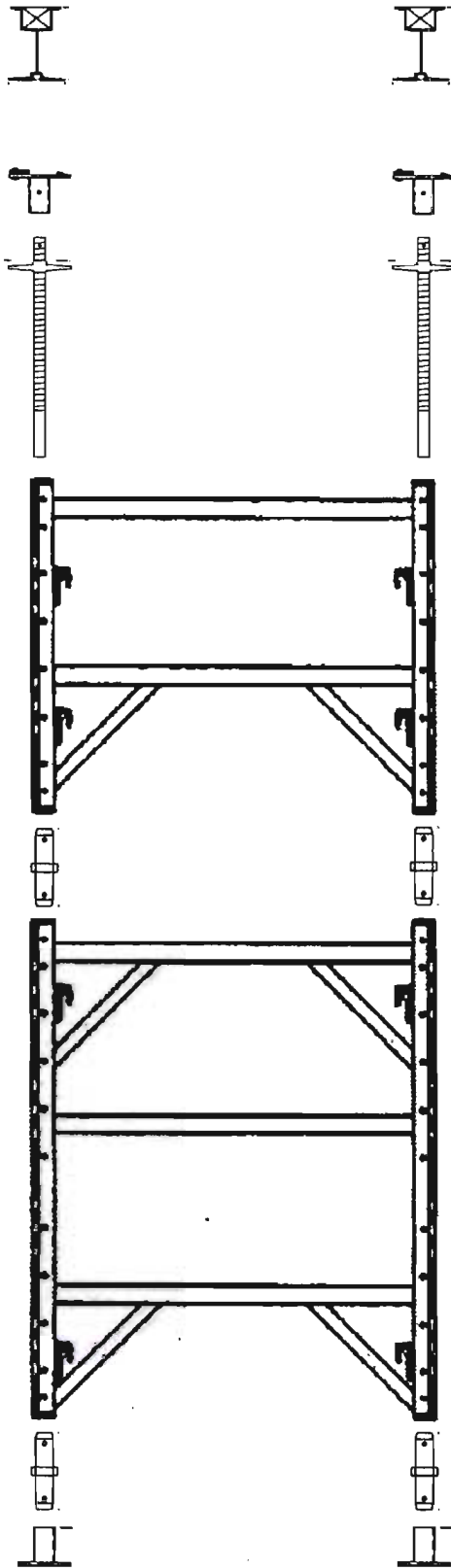

SH 40168  
 Brace  
 Zone 40G

Folder: 08-02-27; SH 40168



SH40168\_3



SH40168\_1



SH40168\_2



SH 40169  
Broken frame part of SH 40165  
Zone 40G

Folder: 08-02-27; SH 40169



SH40169\_1



SH40169\_2

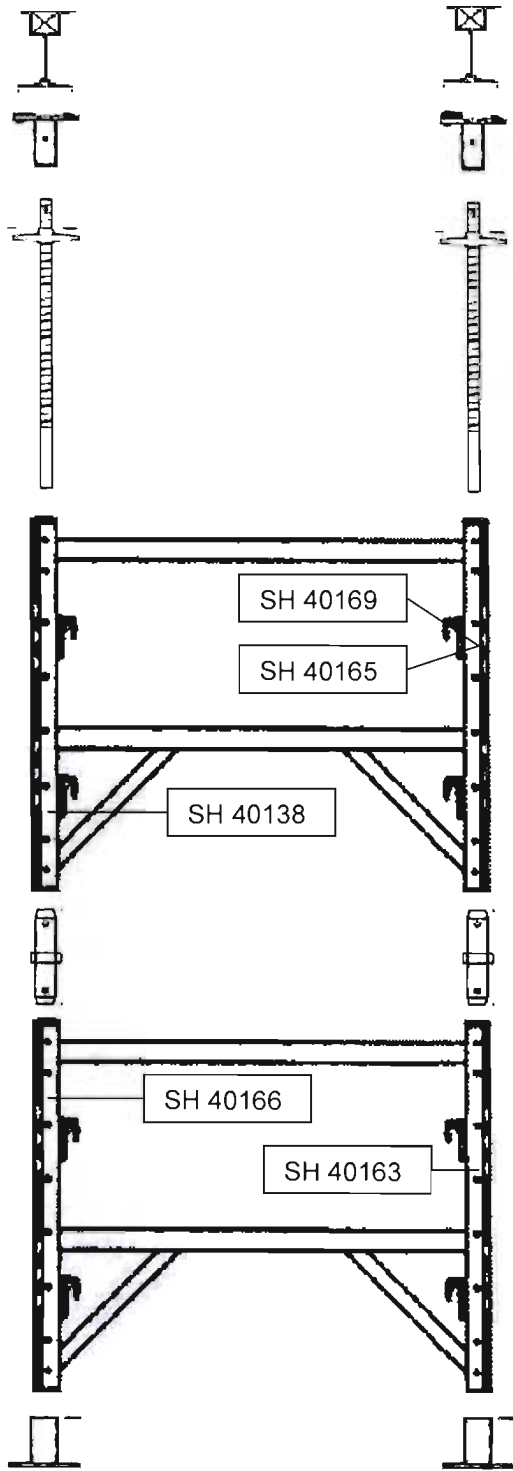

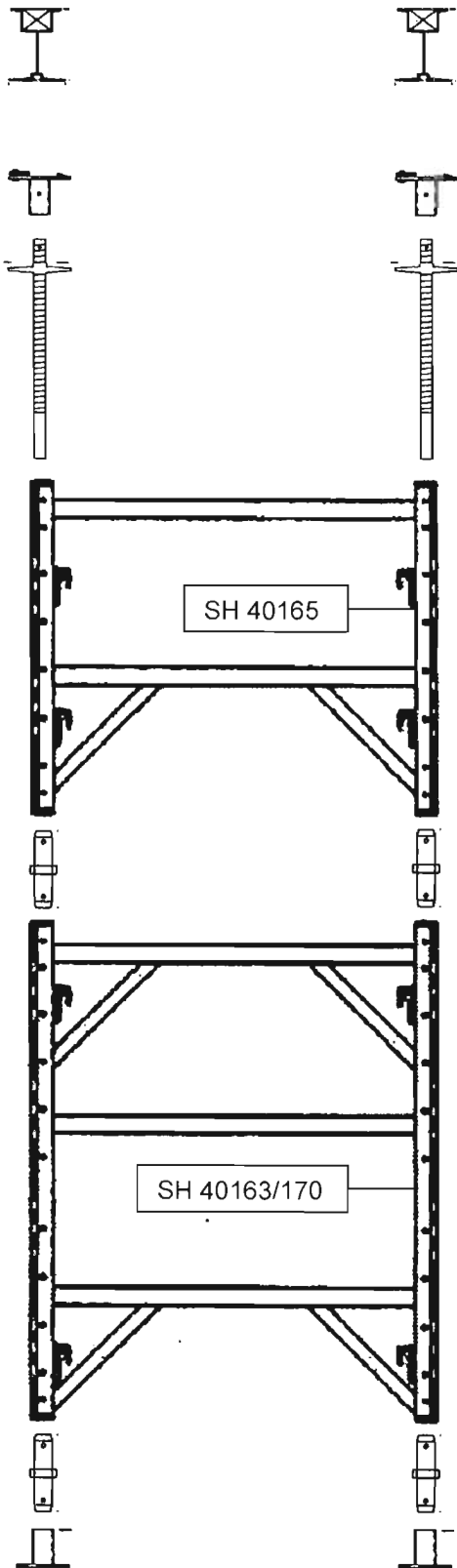

SH 40170  
 Piece of frame  
 Part of SH 40163  
 Zone 40G

Folder: 08-02-27; 08-02-27; SH 40170

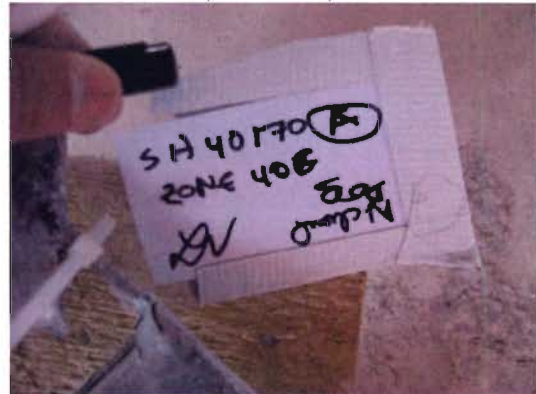

SH40170\_1



SH40170\_2



SH40170\_3

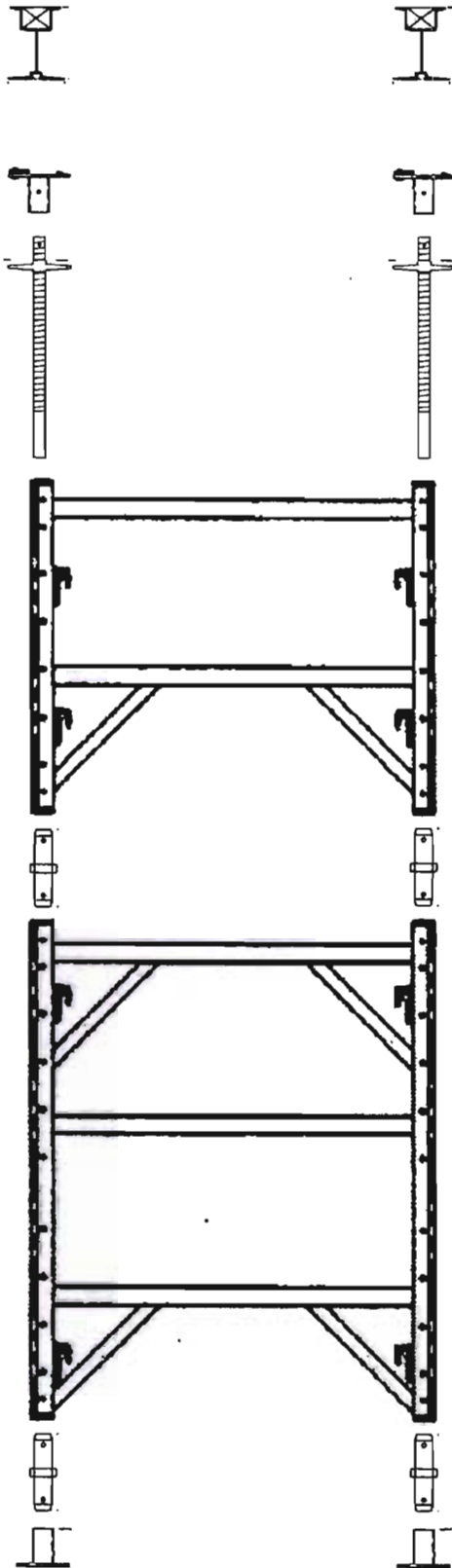

SH 40171  
 Top plate  
 Zone 40F

Folder: 08-02-27; 08-02-27; SH 40171



SH40171\_1



SH40171\_2



SH40171\_3

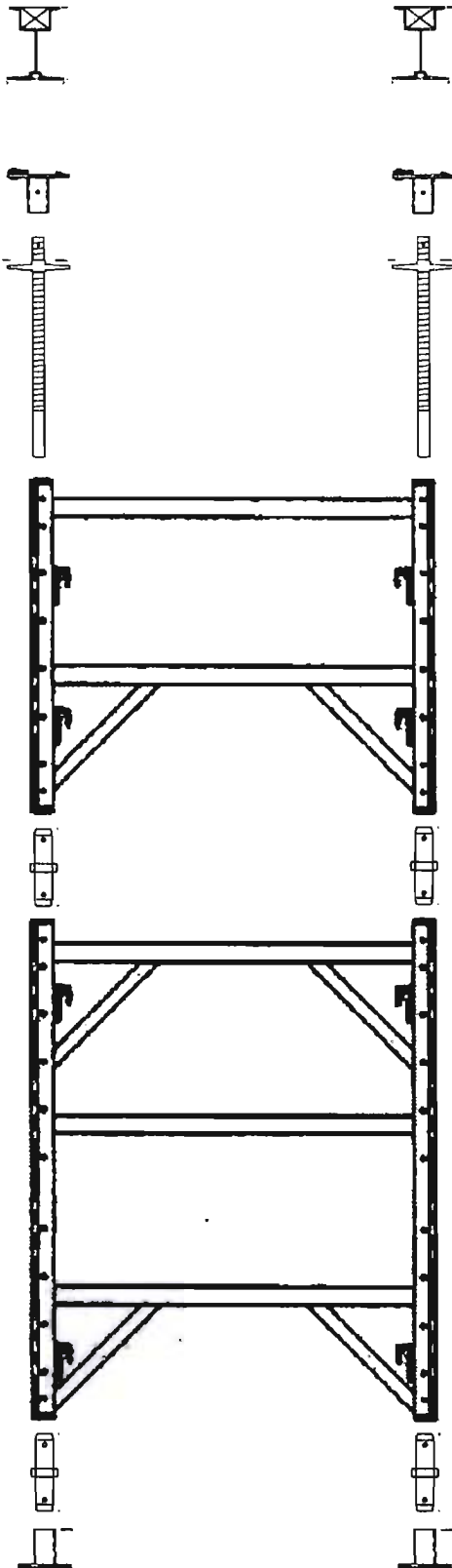

SH 40172  
 Top plate  
 Zone 40F

Folder: 08-02-27; SH

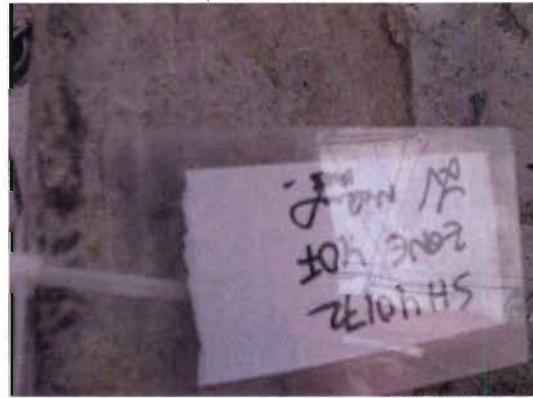

SH40172\_1



SH40172\_2



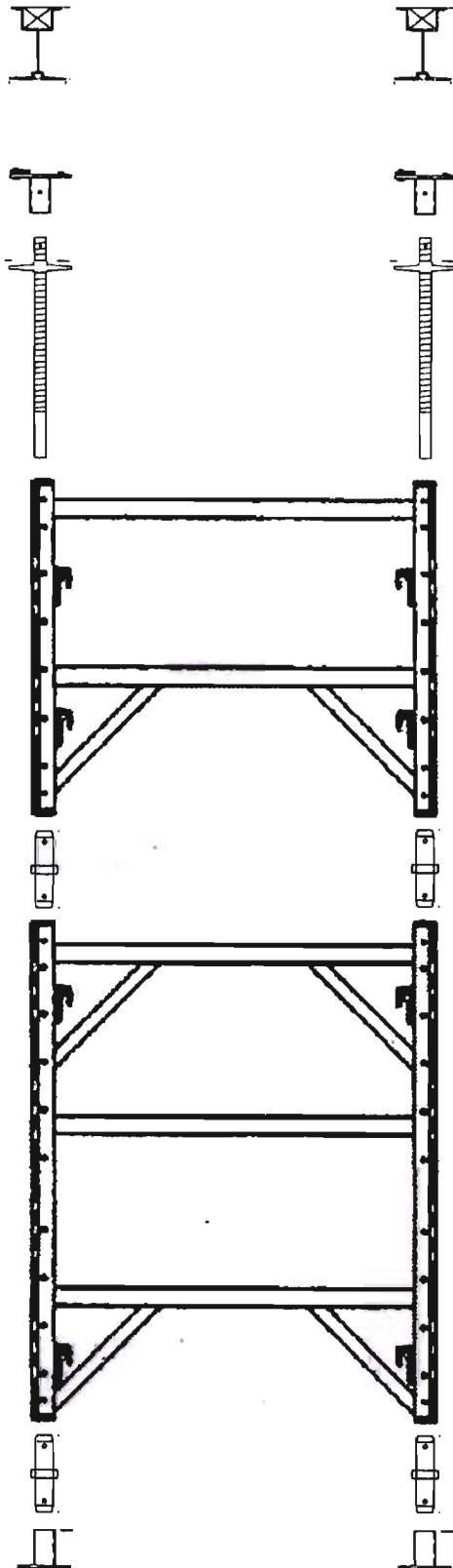

SH 40173  
 Top plate  
 Zone 40F

Folder: 08-02-27; 08-02-27; SH



SH40173\_1



SH40173\_2



SH40173\_3

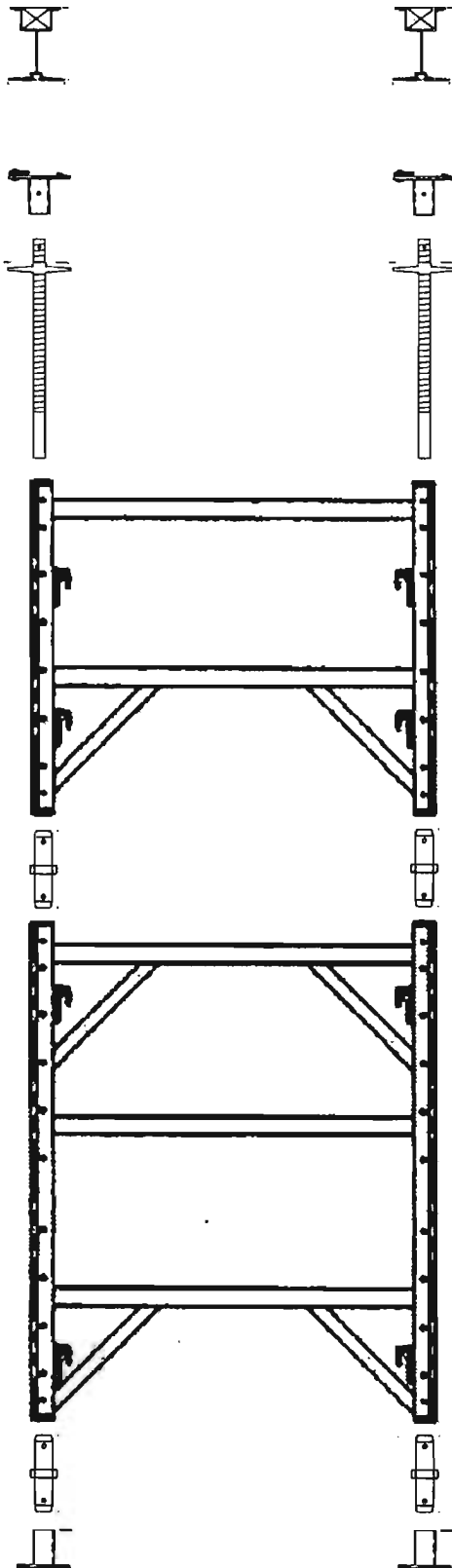

SH 40174  
Bracket  
Zone 40C

Folder: 08-02-27; 08-02-27; SH 40174



SH40174\_1



SH40174\_2



SH40174\_3

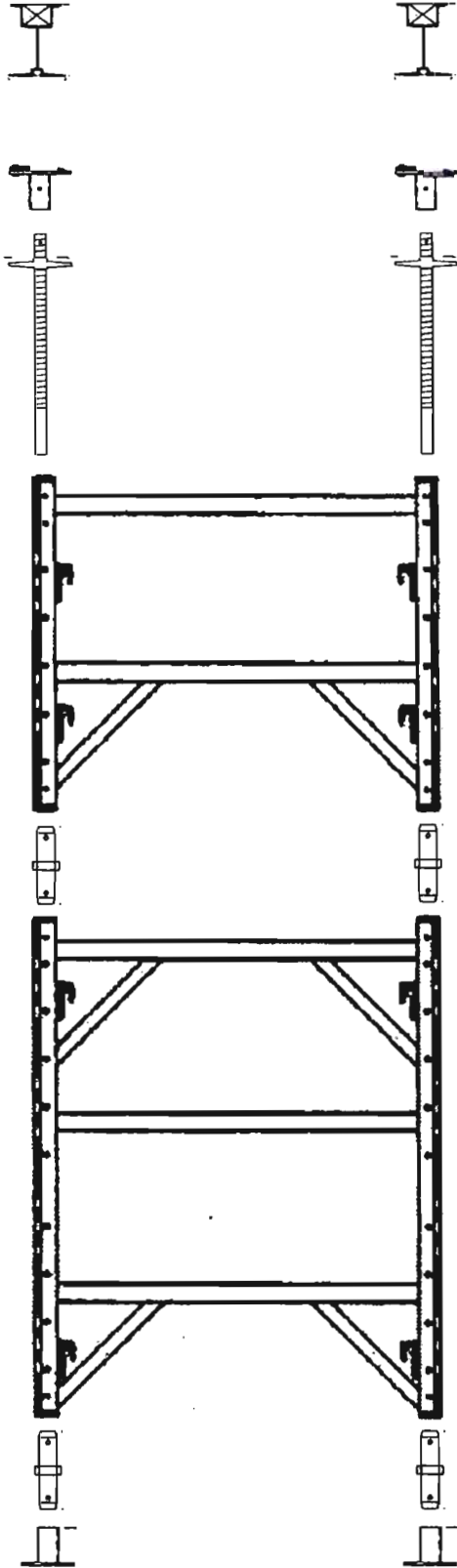

SH 40175  
 Top plate  
 Zone 40F

Folder: 08-02-27; 08-02-27; SH 40175



SH40175\_1



SH40175\_2



SH40175\_3

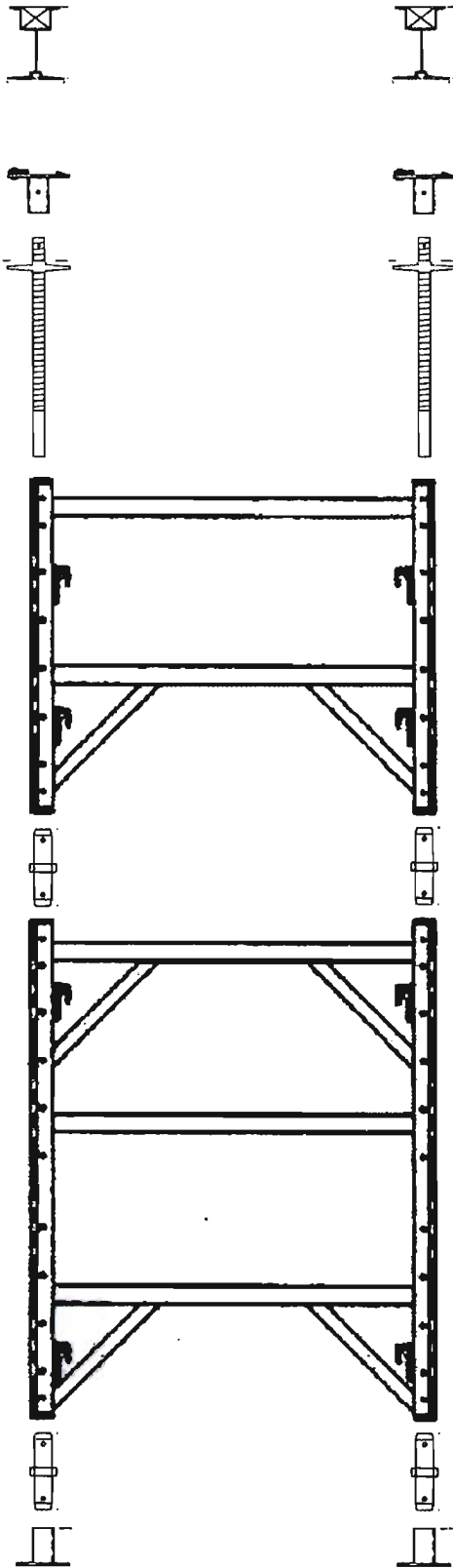

SH 40176  
 Piece of frame, part of frame SH 40180  
 Zone 40G

Folder: 08-02-27; 08-02-27; SH



SH40176\_1



SH40176\_3



SH40176\_4



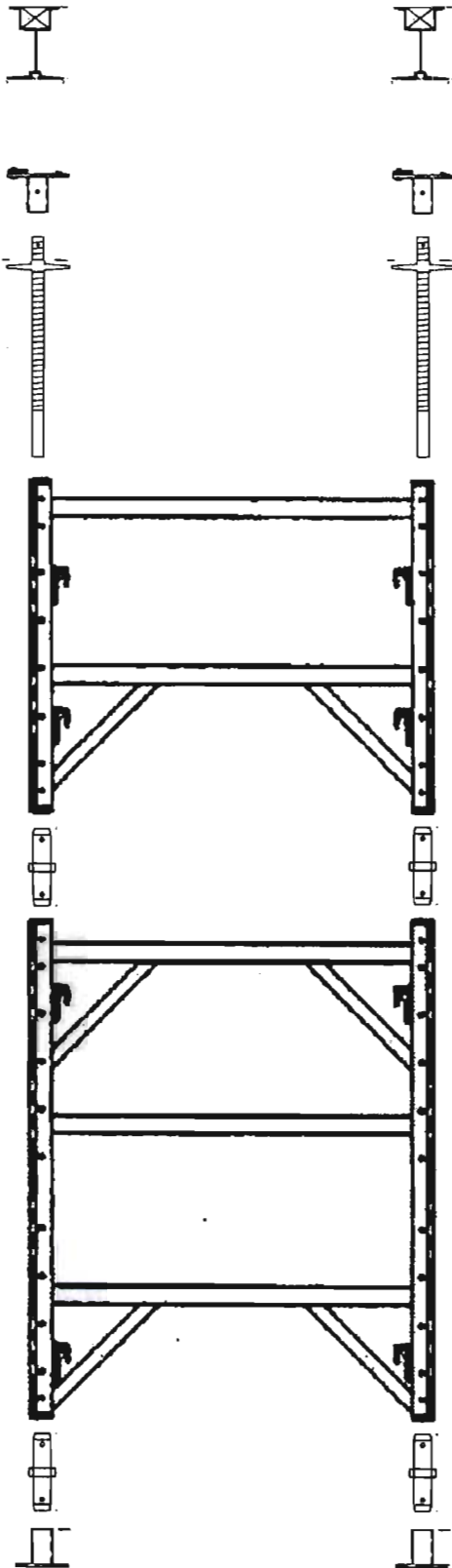

SH 40177  
 Piece of frame  
 Part of SH 40180  
 Zone 40G

Folder: 08-02-27; 08-02-27; SH 40177



SH40177\_1



SH40177\_2



SH40177\_3

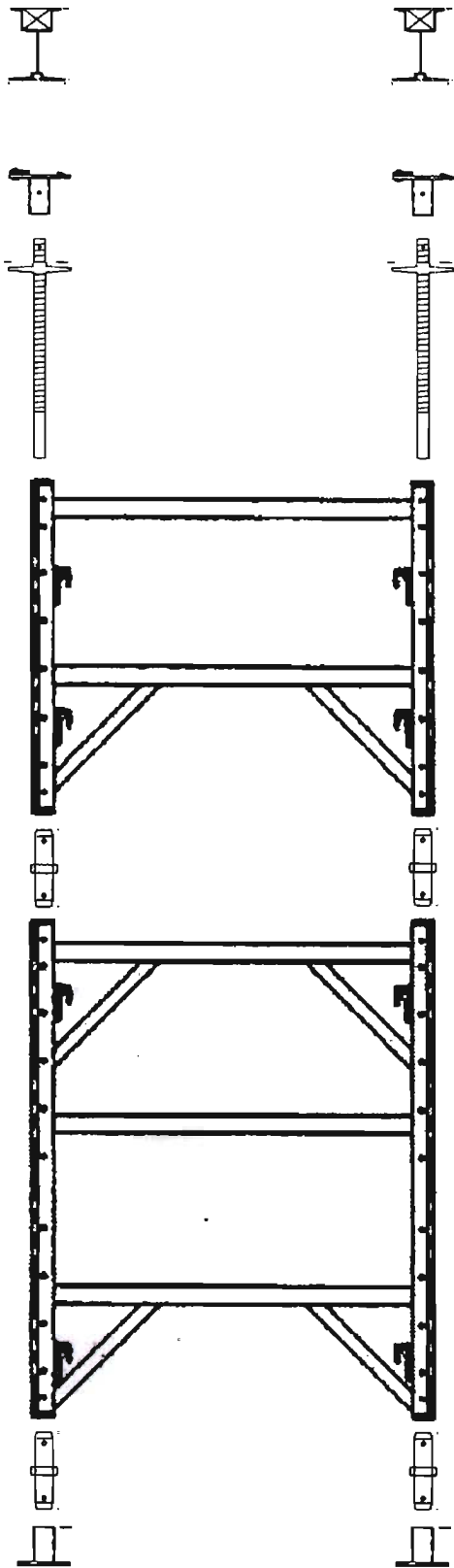

SH 40178  
Coupler  
Zone 40G

Folder: 08-02-27; 08-02-27; SH 40178

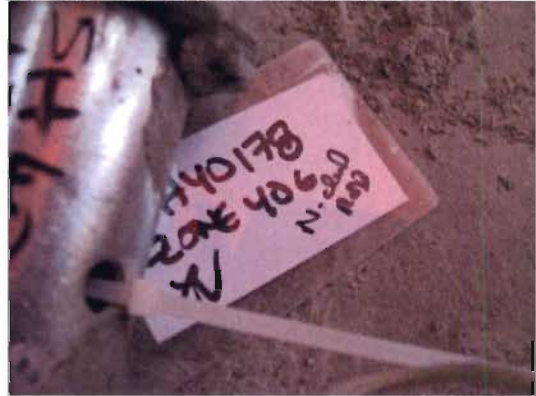

SH40178\_3



SH40178\_1



SH40178\_2

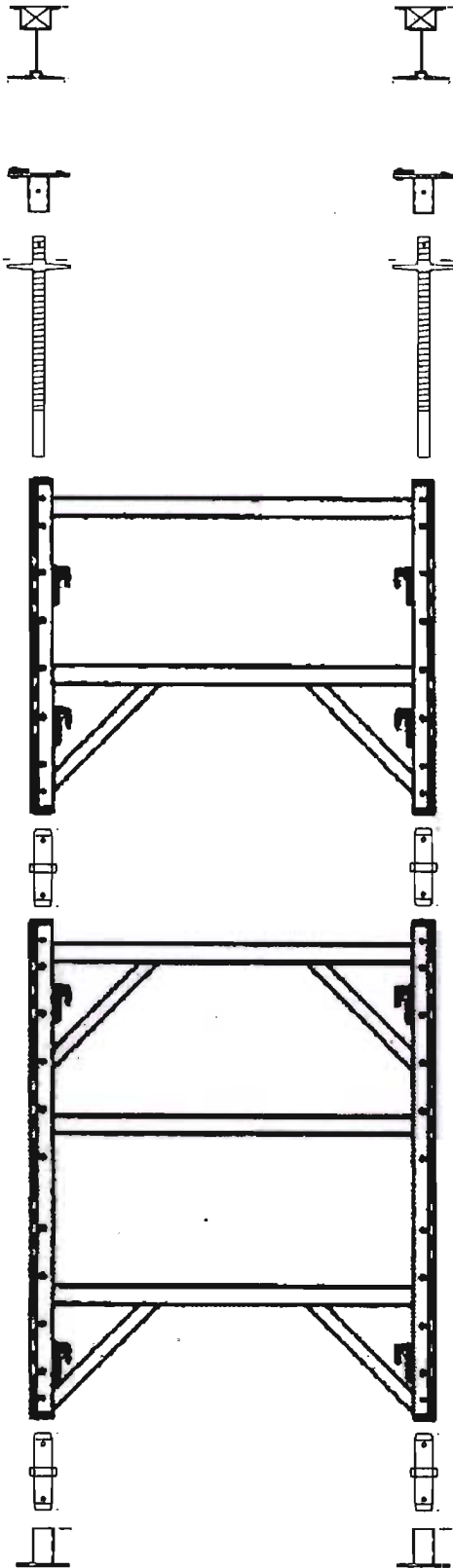

SH 40179  
 Bottom plate  
 Zone 40G

Folder: 08-02-27; 08-02-27; SH 40179



SH40179\_1



SH40179\_2



SH40179\_3



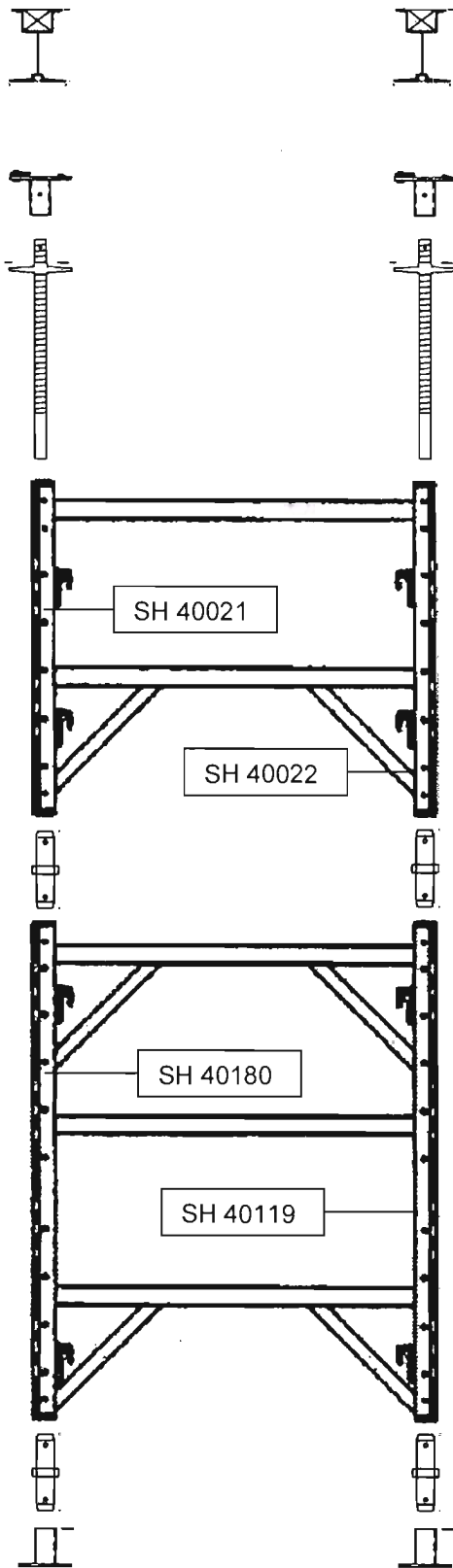

SH 40180  
 Bottom Frame (5'-3") bottom screw jack  
 located near SH 40195/196  
 Zone 40G

Folder: 08-02-27; 08-02-27; SH 40180



SH40180\_1



SH40180\_2



SH40180\_3



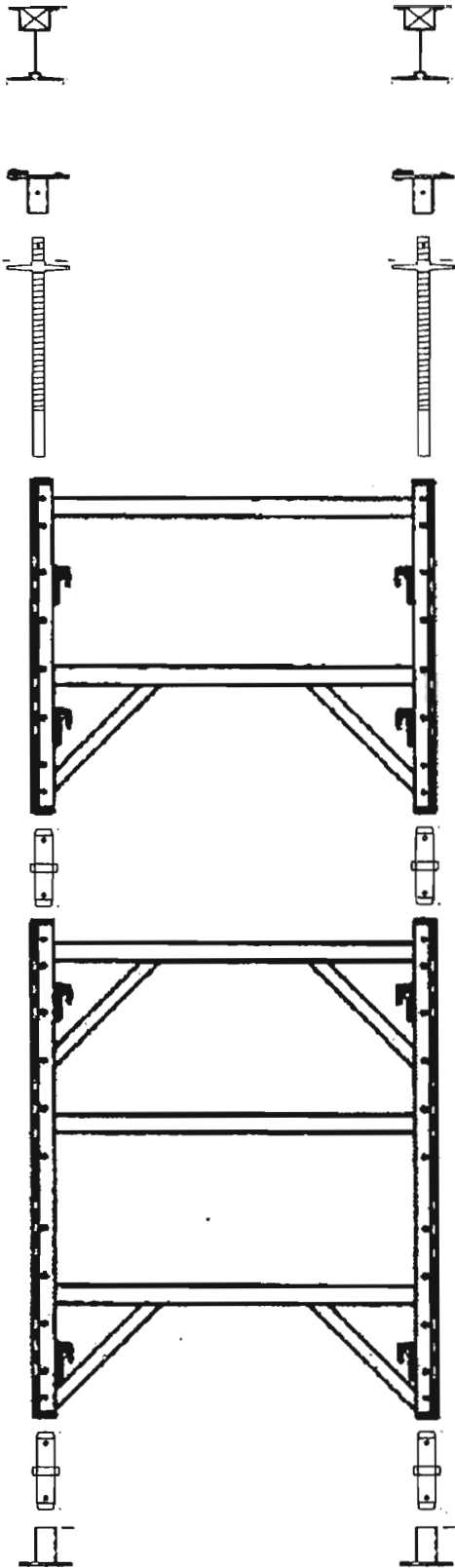

SH 40181  
 Brace  
 Zone 40G

Folder: 08-02-27; 08-02-27; SH 40181



SH40181\_1



SH40181\_2



SH40181\_3

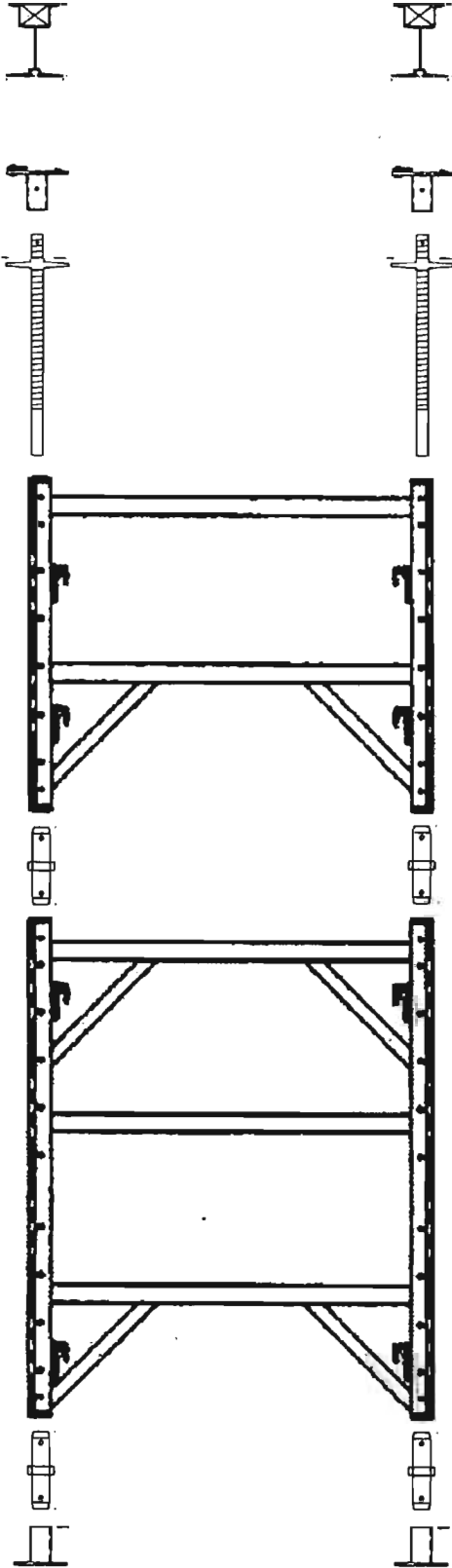

SH 40182  
Piece of SH 40163 Bottom diagonal  
Zone 40G

Folder: 08-02-27; 08-02-27; SH 40182



SH40182\_1

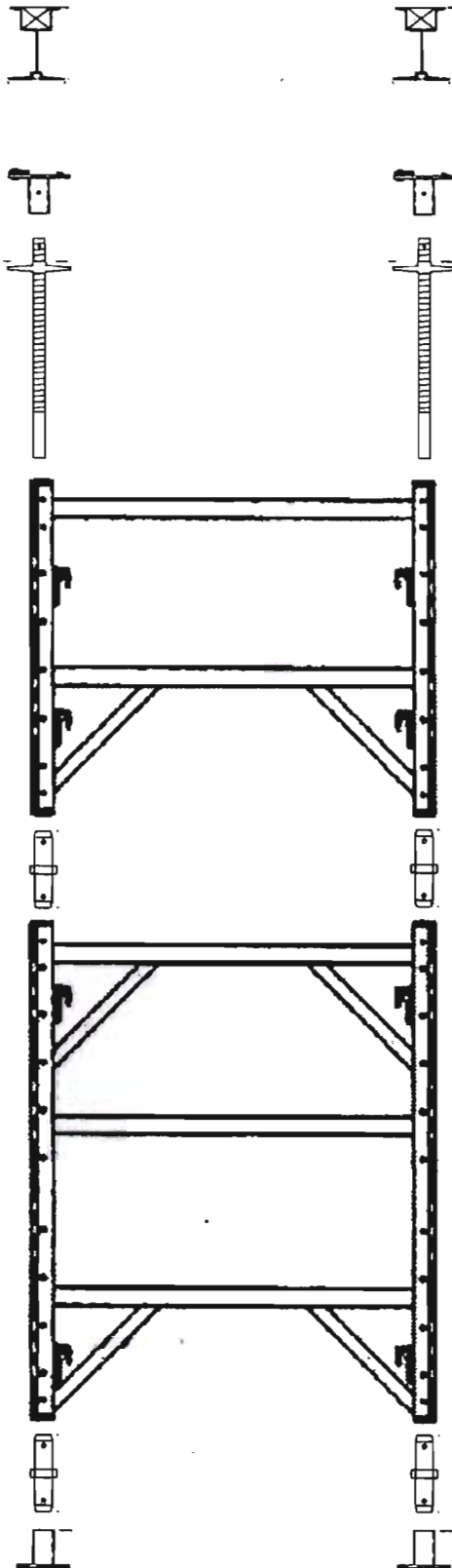

SH 40183  
 Piece of diagonal  
 Zone 40G

Folder: 08-02-27; 08-02-27; SH 40183



SH40183\_1



SH40183\_2



SH40183\_3

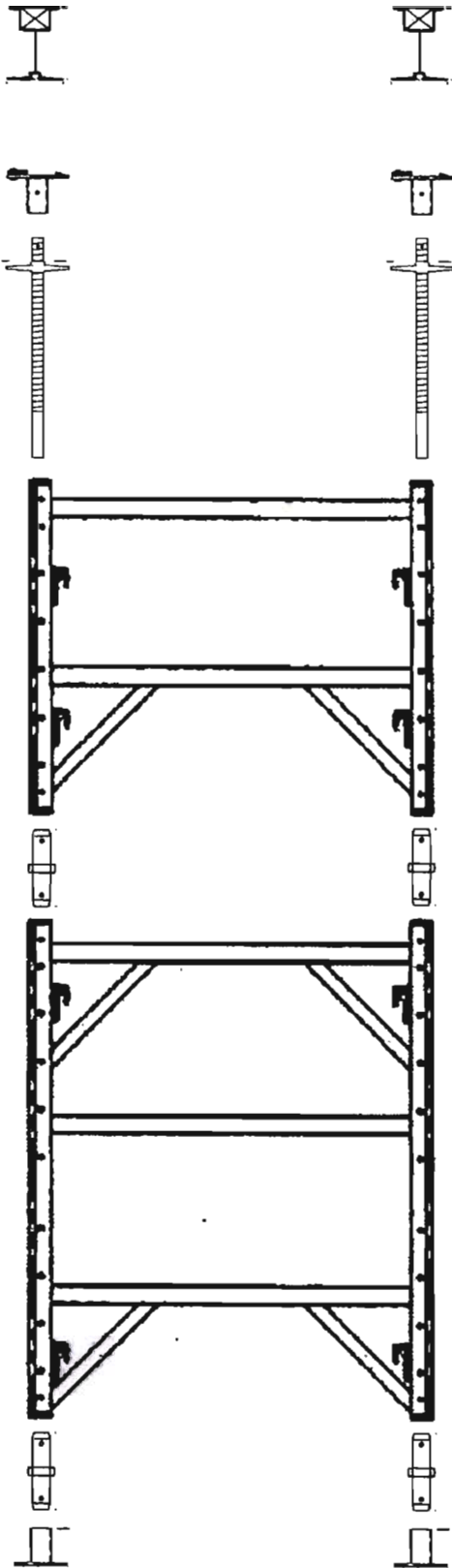

SH 40184  
 Horizontal and diagonal section of Tower  
 part of Frame SH 40180  
 Zone 40G

Folder: 08-02-27; 08-02-27; SH 40184



SH40184\_1



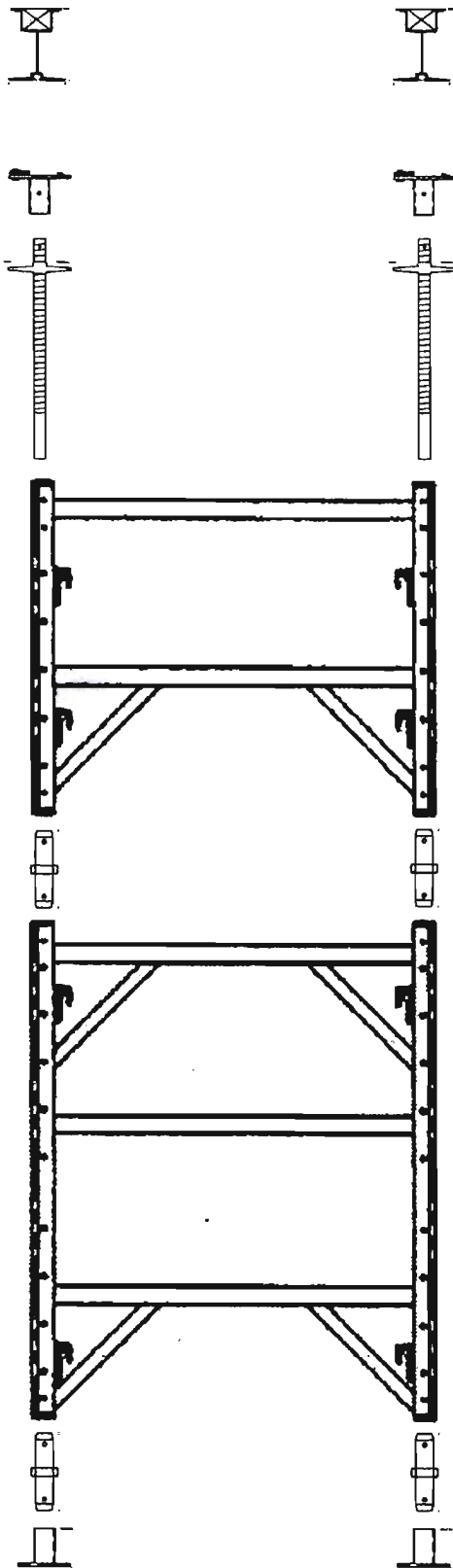

SH 40185  
 Brace  
 Zone 40G

Folder: 08-02-27; 08-02-27; SH 40185

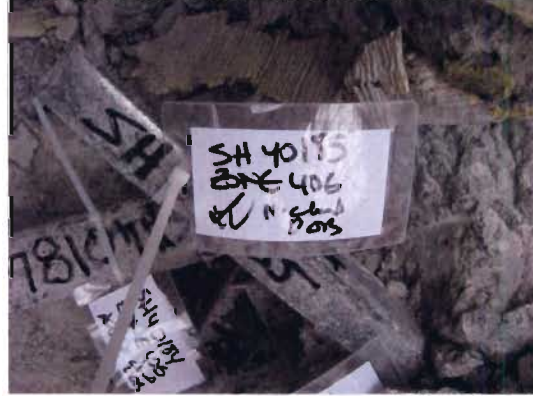

SH40185\_1

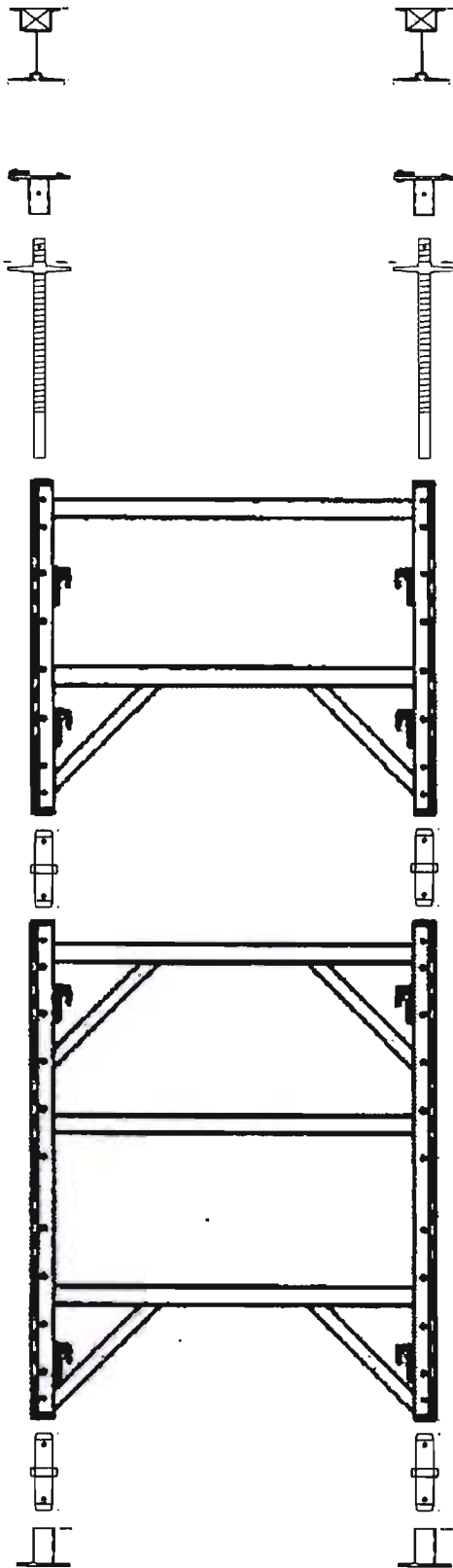

SH 40186  
 Horizontal and Diagonal section of Tower  
 Part of SH 40180  
 Zone 40G

Folder: 08-02-27; 08-02-27; SH 40186

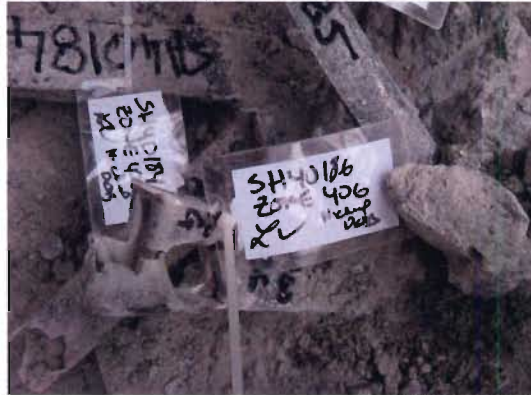

SH40186\_1

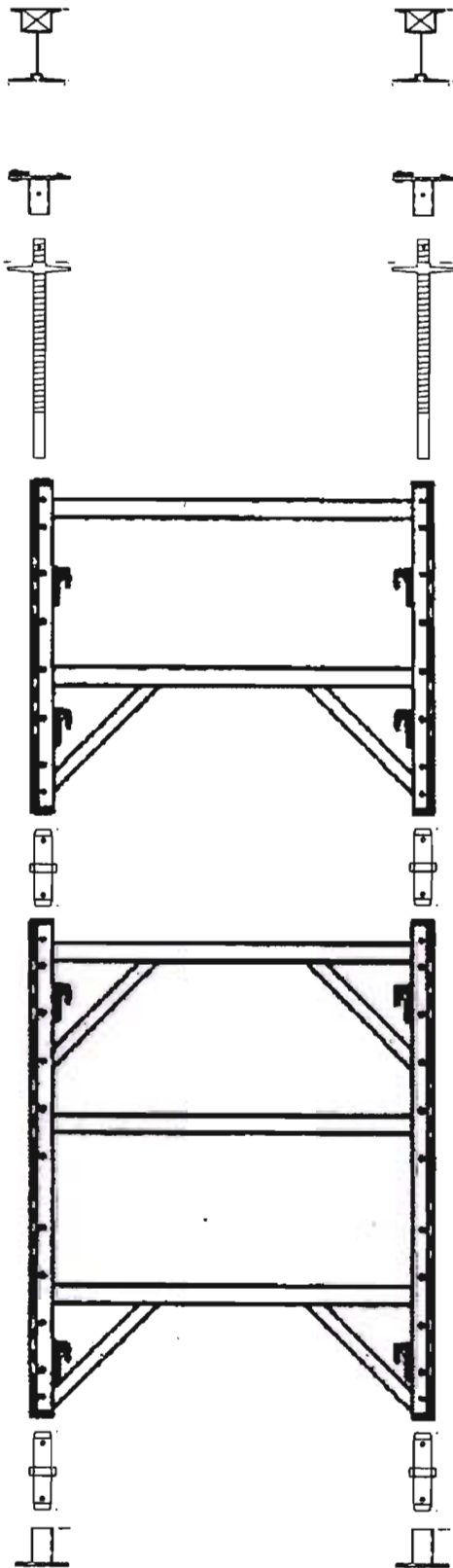

SH 40187  
 Horizontal and Diagonal section of tower  
 Part of SH 40135  
 Zone 40G

Folder: 08-02-27; 08-02-27; SH 40187



SH40187\_1

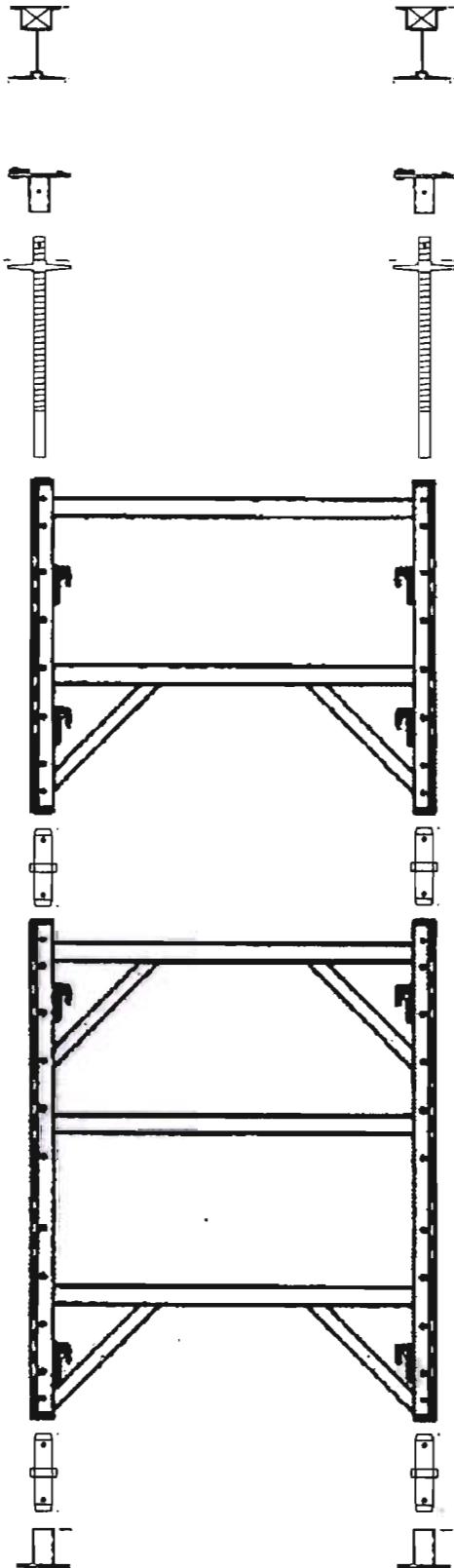

SH 40188  
 Brace connect to SH 40135  
 Zone 40G

Folder: 08-02-27; 08-02-27; SH 40188



SH40188\_1



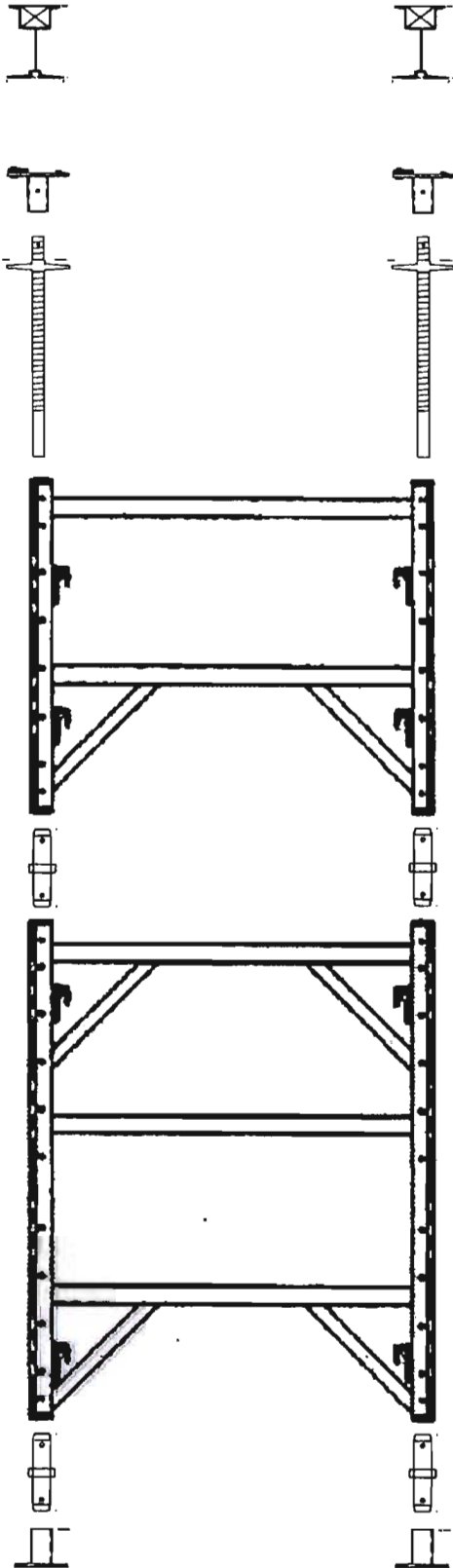

SH 40189  
 Bottom plate  
 Zone 40G

Folder: 08-02-28; 08-02-28; SH 40189



SH40189\_1



SH40189\_2



SH40189\_3

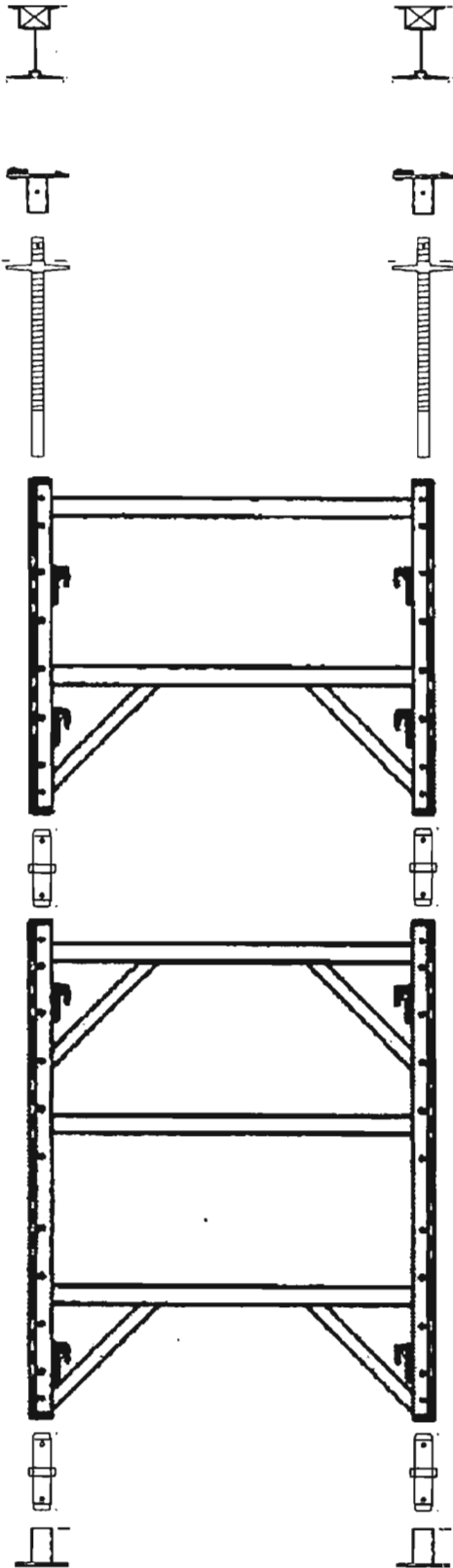

SH 40190  
 Bottom plate  
 Zone 40G

Folder: 08-02-28; 08-02-28; SH 40190

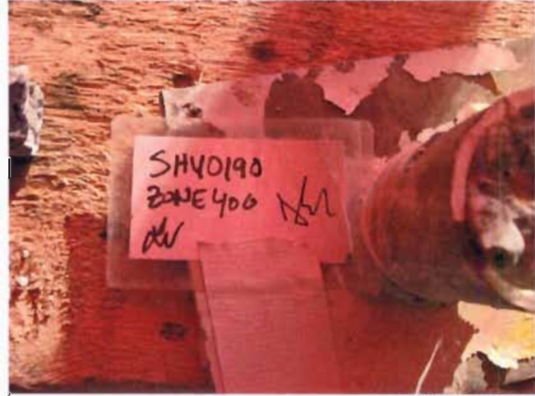

SH40190\_1



SH40190\_2



SH40190\_3

SH 40191  
Top Frame connected to SH 40135 on 41<sup>st</sup>  
floor  
Zone 40G-F

Folder: 08-02-28; 08-02-28; SH 40191

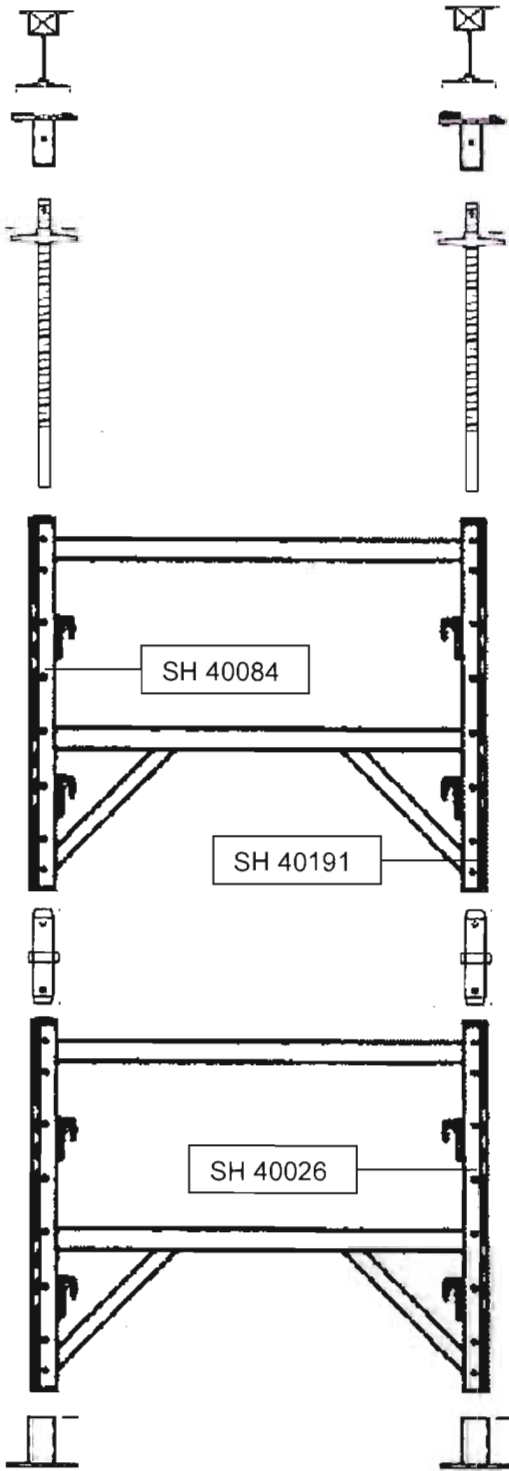

SH40191\_1



SH40191\_2



SH40191\_3



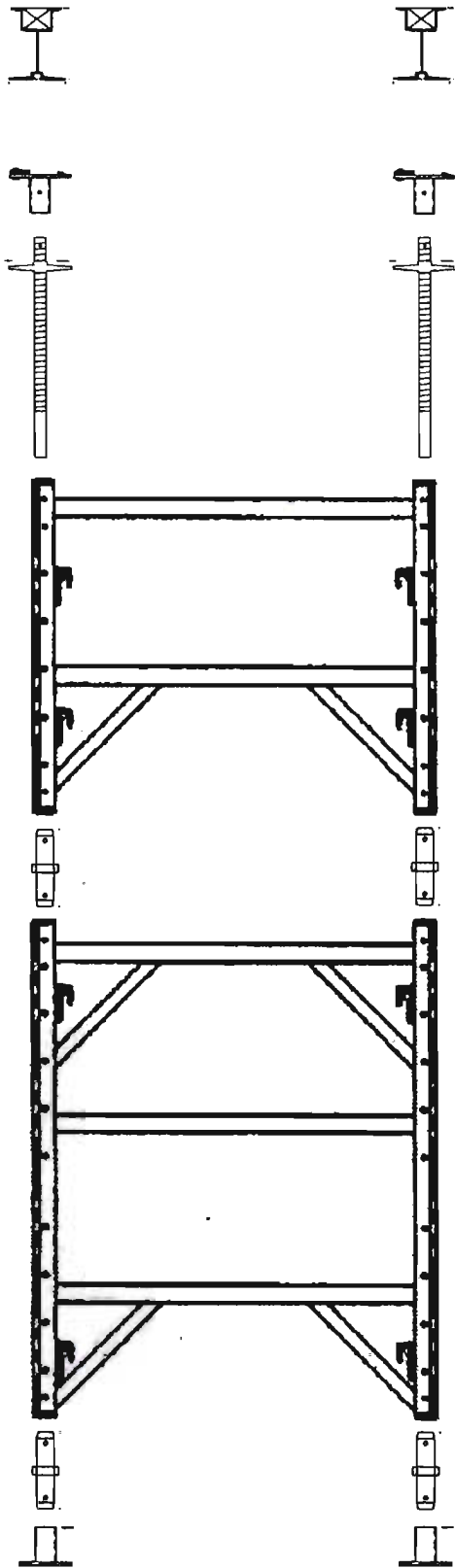

SH 40192  
 Piece of frame  
 Part of SH 40180  
 Zone 40G

Folder: 08-02-28; 08-02-28; SH 40192



SH40192\_1



SH40192\_2



SH40192\_3



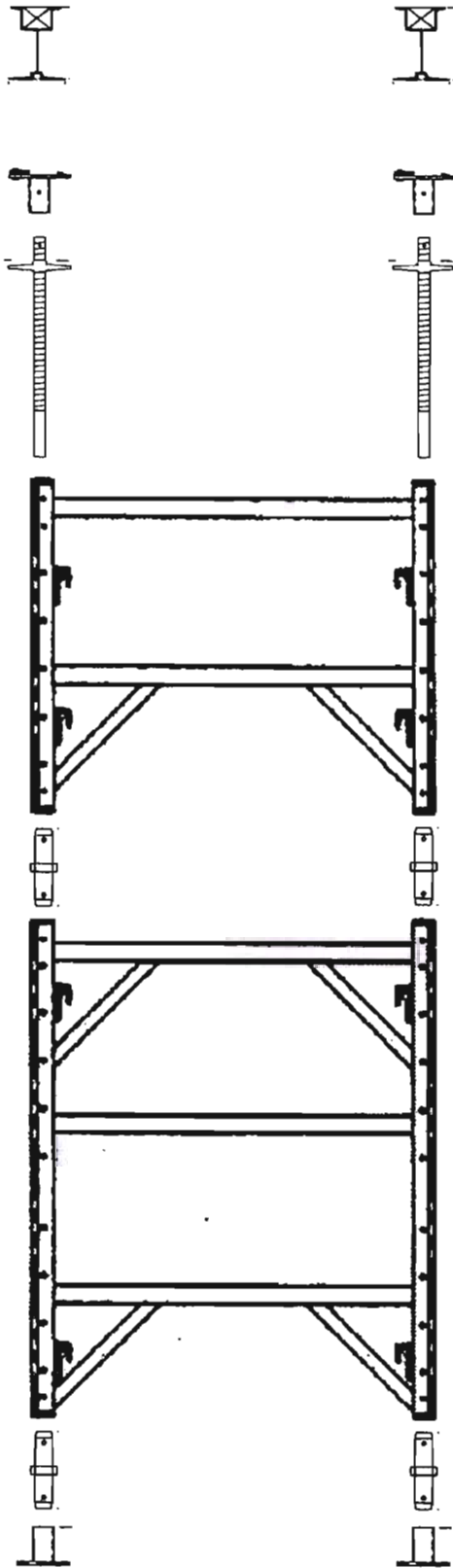

SH 40193  
 Piece of frame  
 Zone 40G

Folder: 08-02-28; 08-02-28; SH



SH40193\_1



SH40193\_2



SH40193\_3

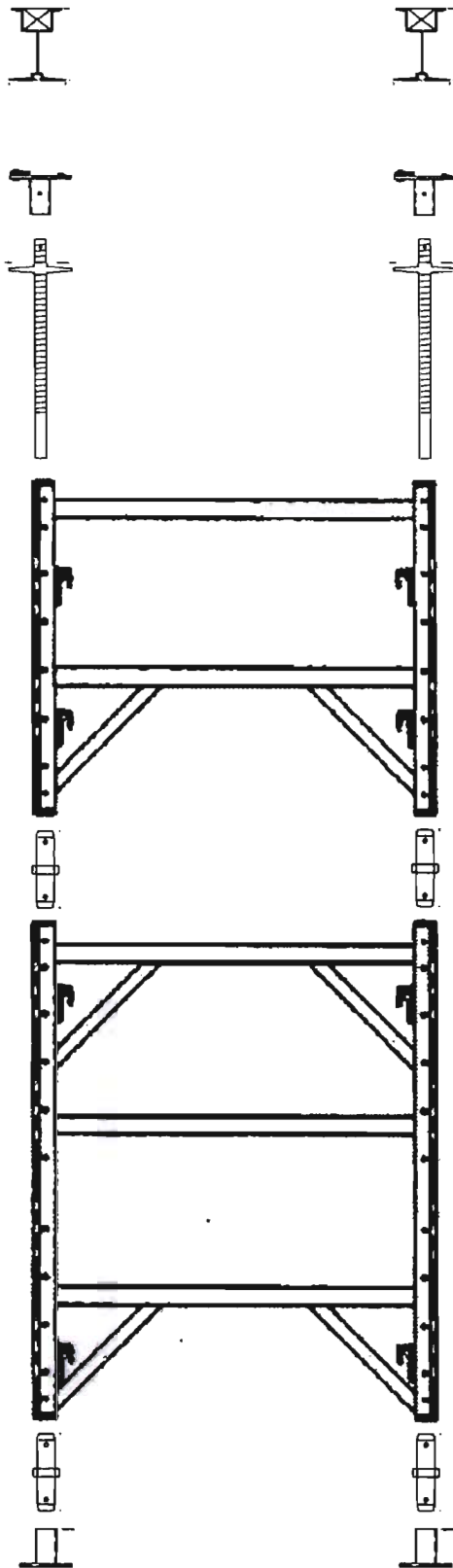

SH 40194  
 Bottom plate  
 Zone 40G

Folder: 08-02-28; 08-02-28; SH



SH40194\_1



SH40194\_2



SH40194\_3

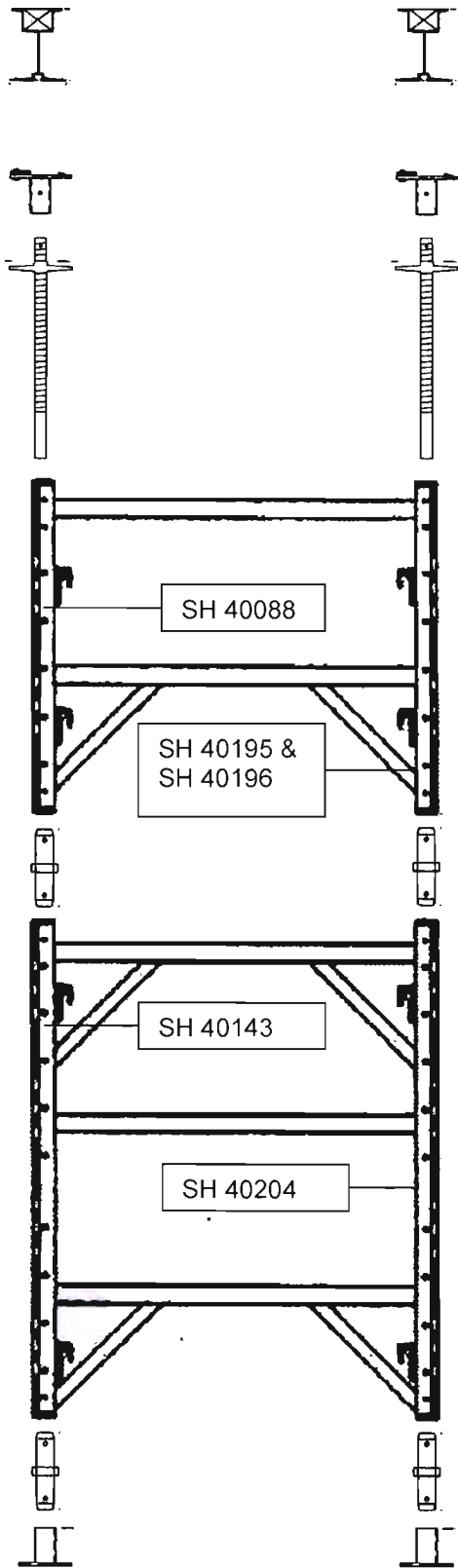

SH 40195  
 Top frame fractured off from SH 40196  
 SH 40185 and SH 40195 were connected  
 Zone 40C

Folder: 08-02-28; 08-02-28; SH 40195



SH40195\_1



SH40195\_2



SH40195\_3



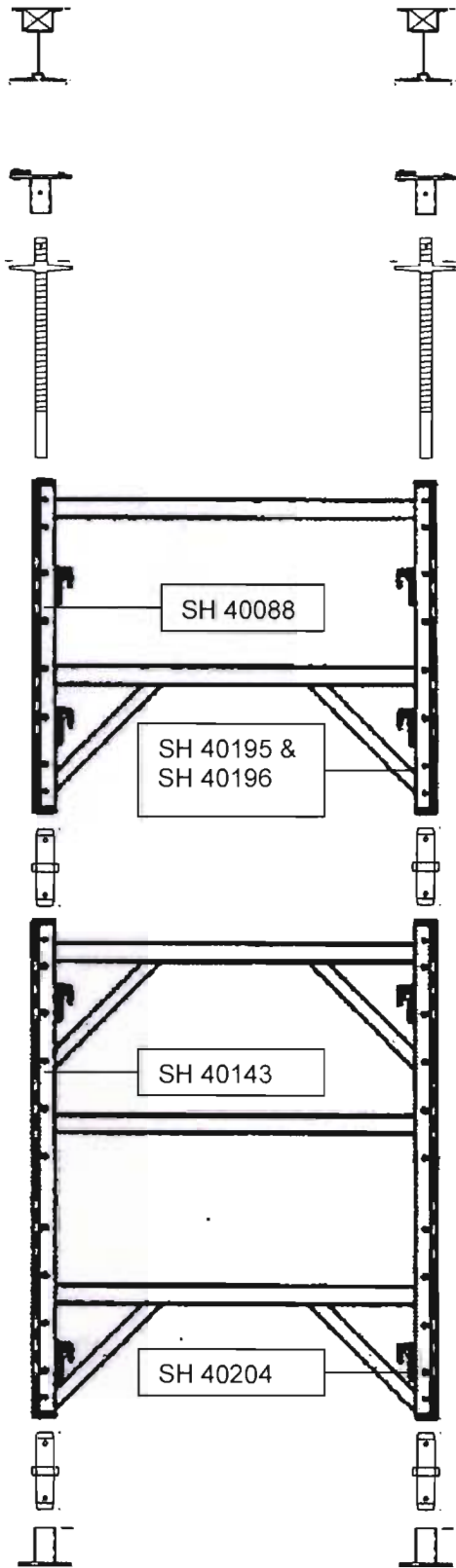

SH 40196  
 Remaining fractured part of SH 40195 frame  
 buried in concrete  
 Zone 40C

Folder: 08-02-28; 08-02-28; SH 40196



SH40196\_1



SH40196\_2



SH40196\_3



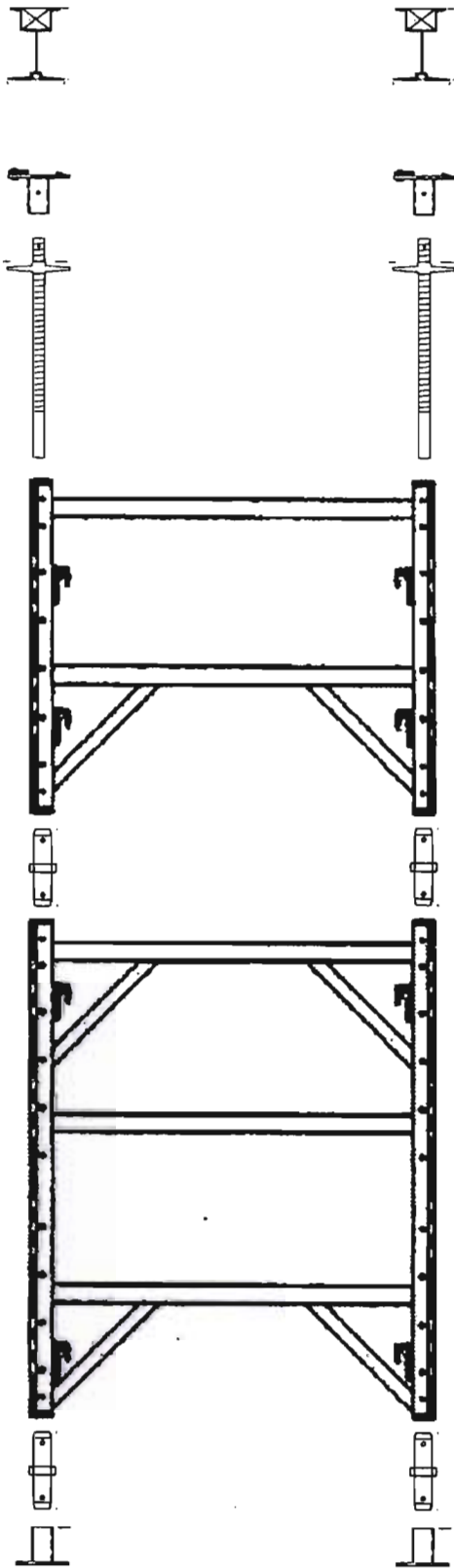

SH 40197  
 Bottom plate  
 Zone 40C

Folder: 08-02-28; 08-02-28; SH 40197



SH40197\_1



SH40197\_2



SH40197\_4

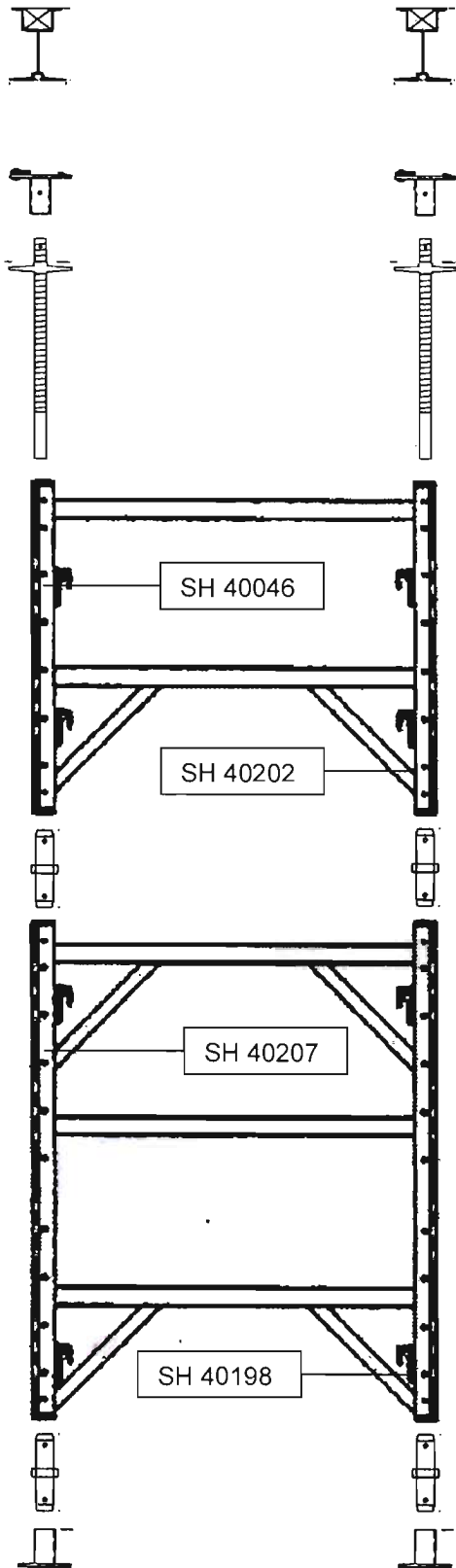

SH 40198  
 Frame buried in concrete  
 Zone 40C

Folder: 08-02-28; 08-02-28; SH 40198



SH40198\_1



SH40198\_2



SH40198\_4

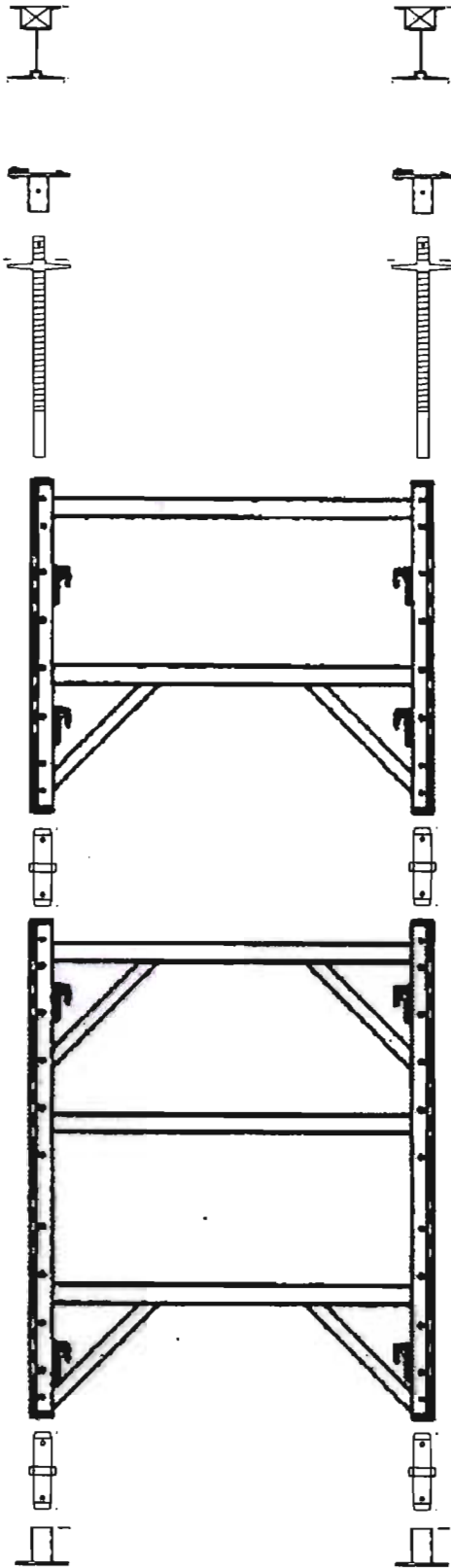

SH 40199  
 Coupler buried in Concrete  
 Zone 40C

Folder: 08-02-28; 08-02-28; SH 40199

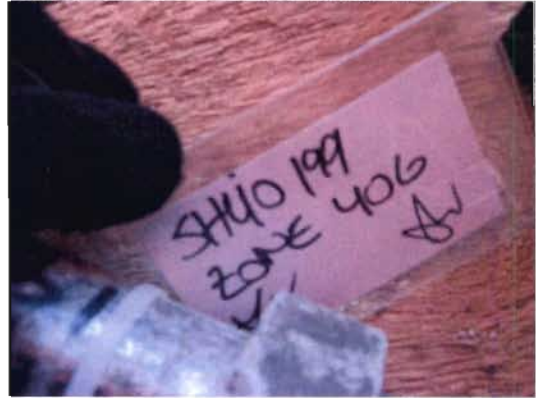

SH40199\_1



SH40199\_2



SH40199\_3



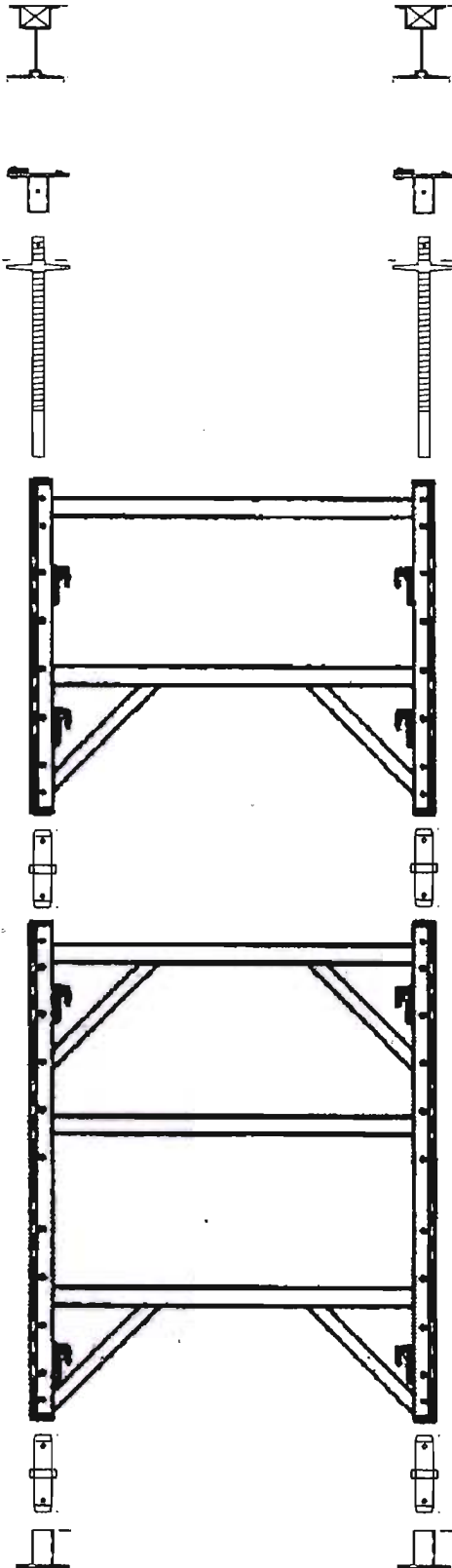

SH 40200  
 Brace buried in concrete  
 Zone 40C

Folder: 08-02-28; 08-02-28; SH 40200



SH40200\_1



SH40200\_2



SH40200\_3



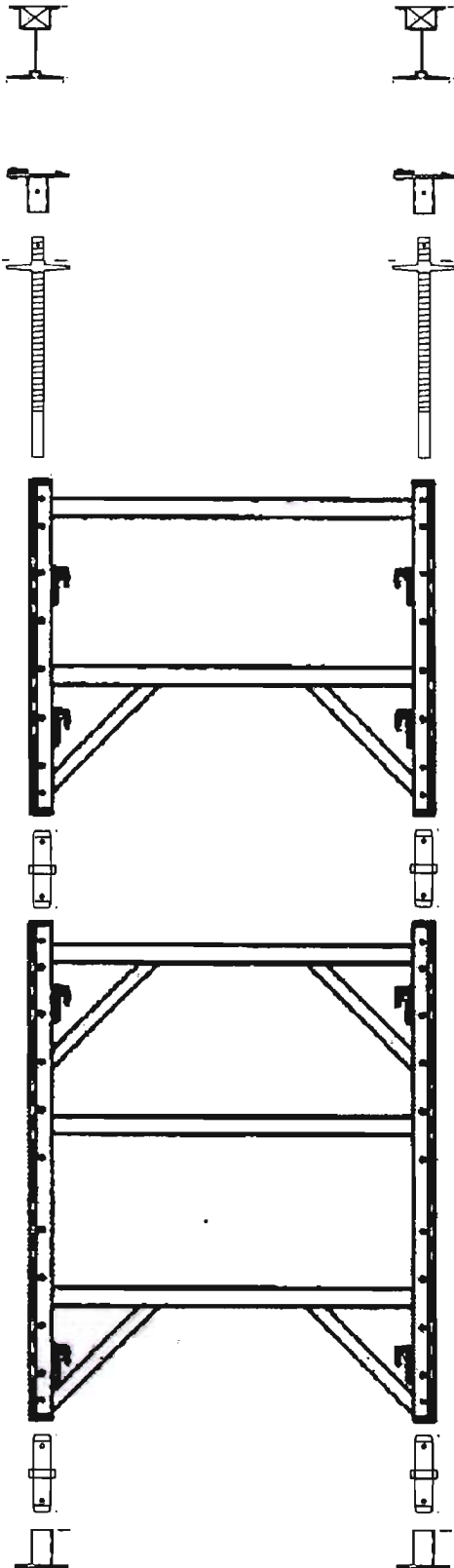

SH 40201  
 Brace  
 Zone 40C

Folder: 08-02-28; 08-02-28; SH 40201



SH40201\_1



SH40201\_2

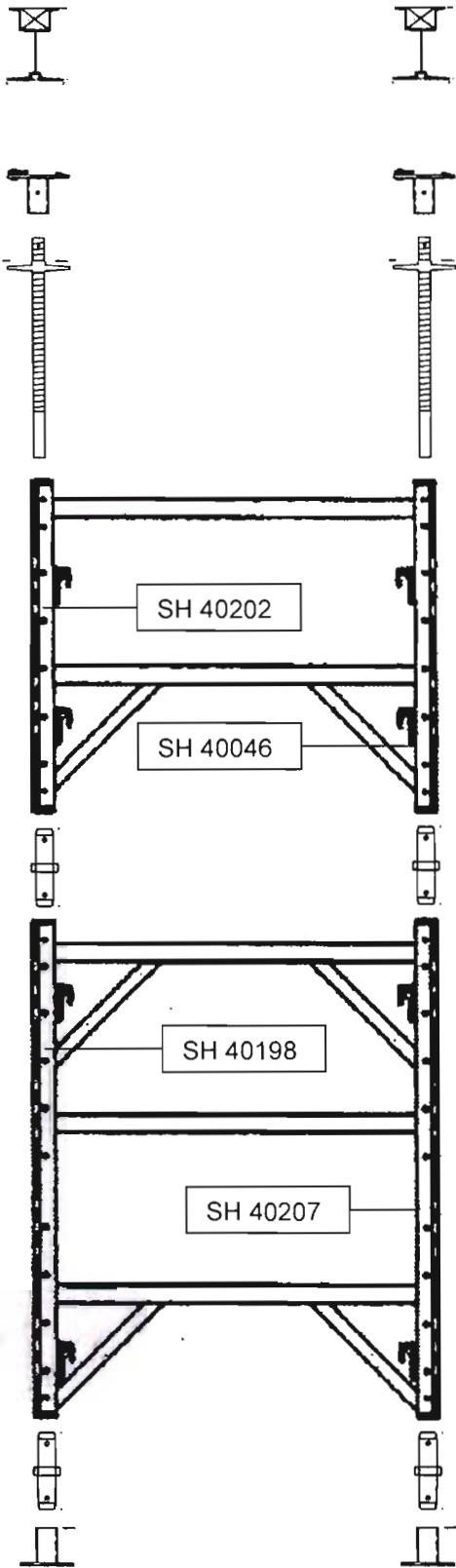

SH 40202  
 Shoring tower  
 Zone 40C

Folder: 08-02-28; 08-02-28; SH 40202



SH40202\_1



SH40202\_2



SH40202\_3

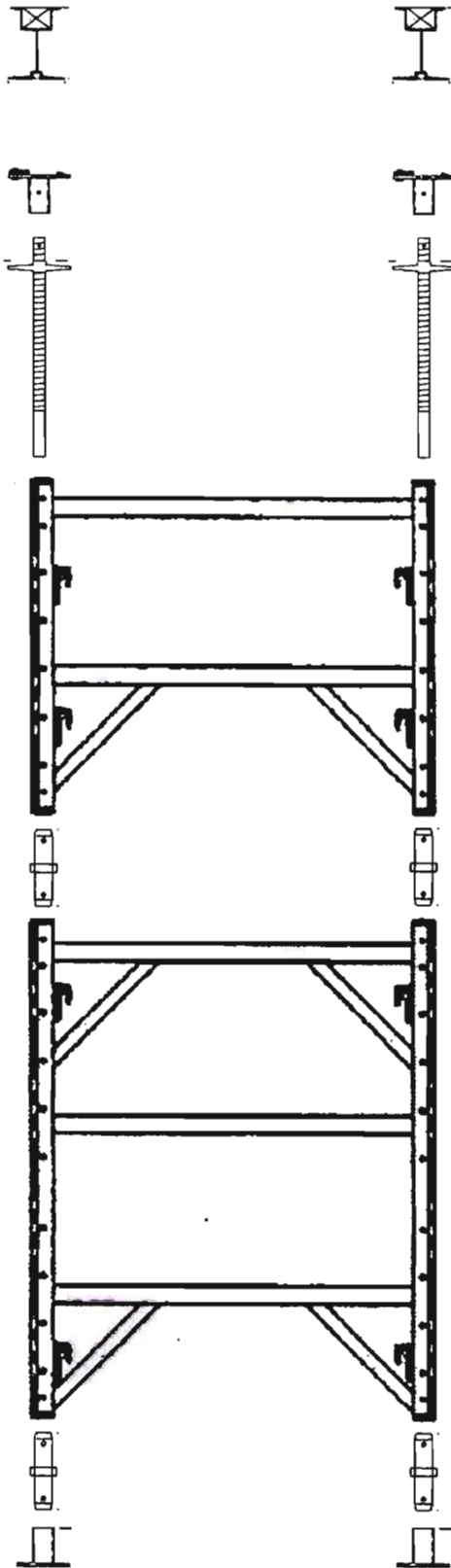

SH 40203  
 Piece of Frame  
 Zone 40G

Folder: 08-02-28; 08-02-28; SH 40203

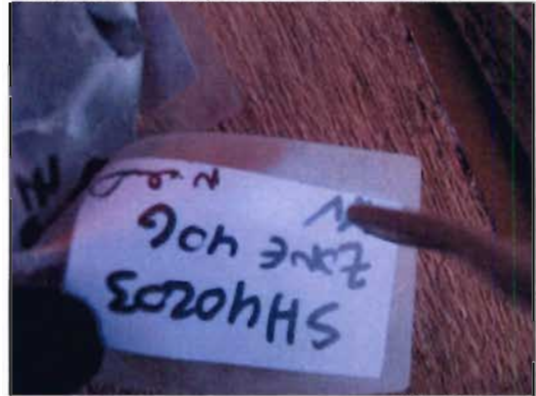

SH40203\_2



SH40203\_3



SH40203\_4