

SH 40204  
 Bottom Frame buried  
 Zone 40C

Folder: 08-02-28; 08-02-28; SH 40204

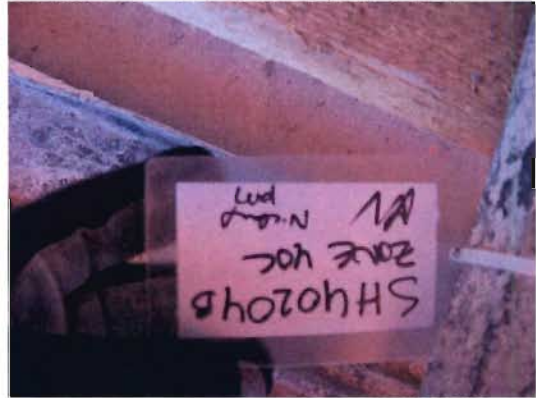

SH40204\_1



SH40204\_2



SH40204\_3

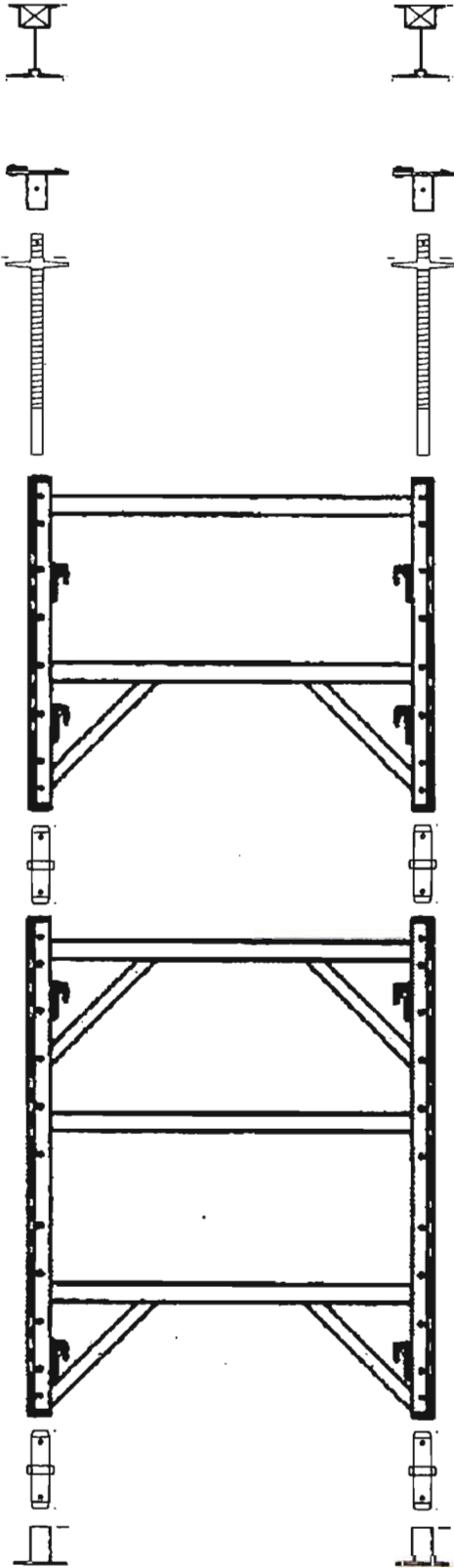

SH 40205  
 Piece of frame  
 Zone 40C

Folder: 08-02-28; 08-02-28; SH 40205



SH40205\_1



SH40205\_2



SH40205\_3

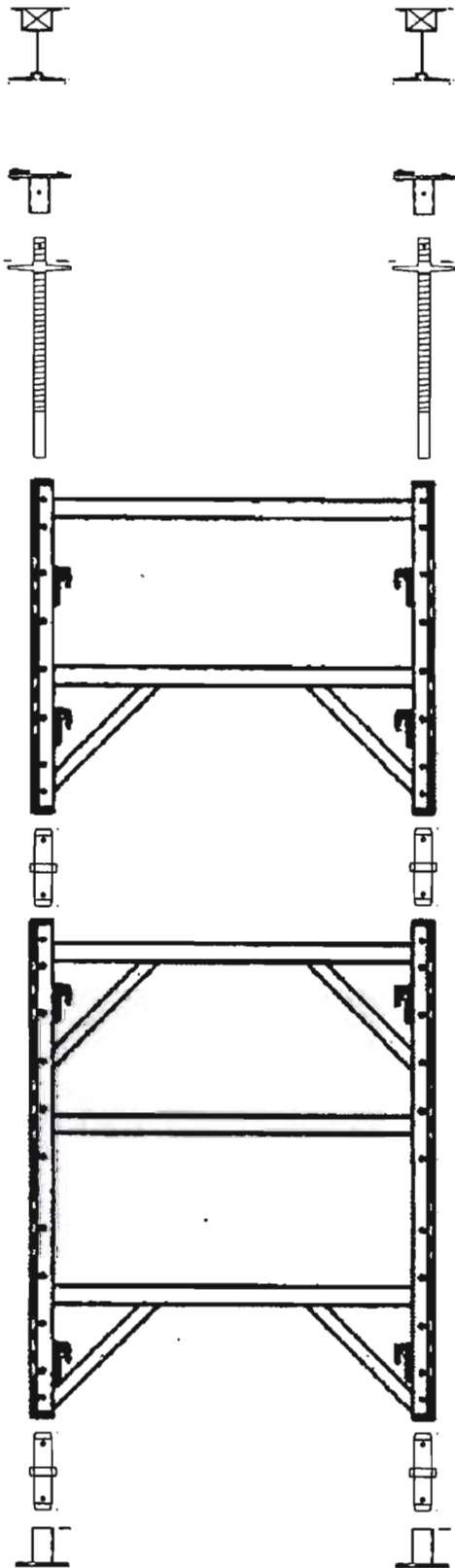

SH 40206  
 Top piece connect to SH 40196(Top plate)  
 Zone 40C

Folder: 08-02-28; 08-02-28; SH 40206

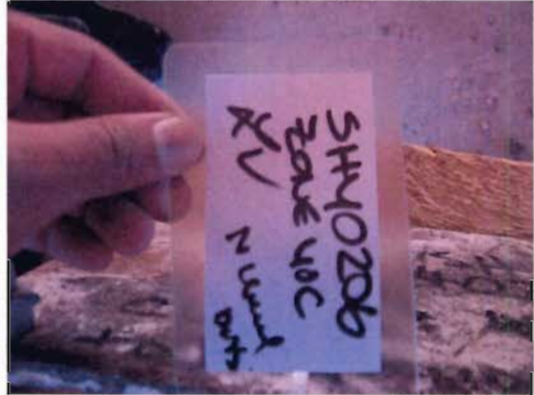

SH40206\_1



SH40206\_2



SH40206\_3

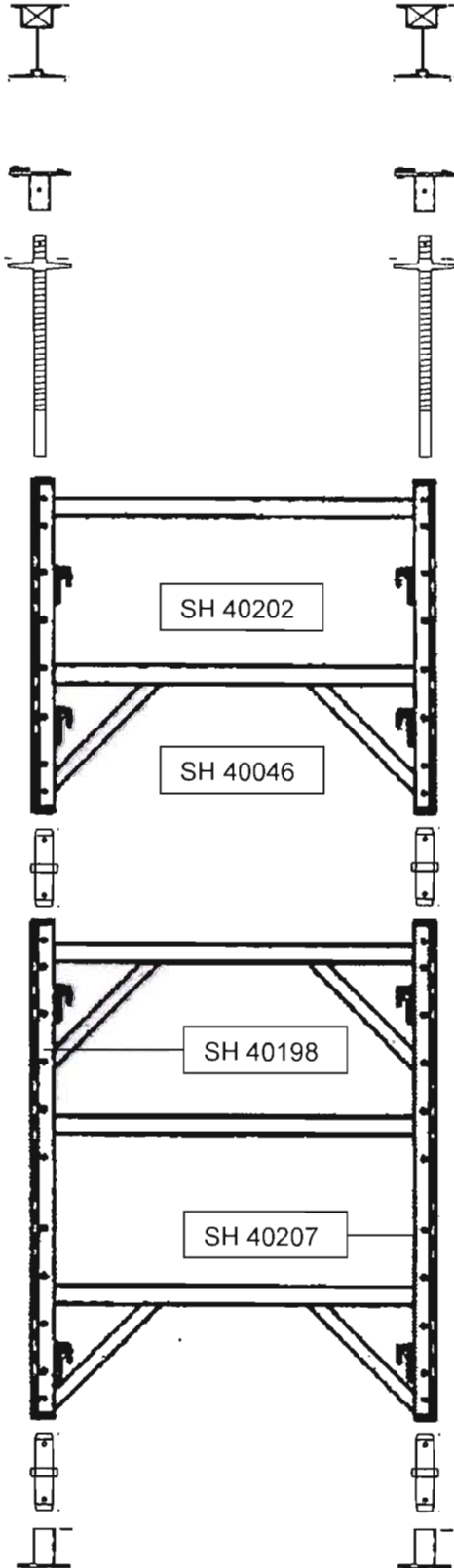

SH 40207  
 Bottom Frame Broken (torched)  
 Zone 40C

Folder: 08-02-29; SH 40207



SH40207\_3



SH40207\_4



SH40207\_2

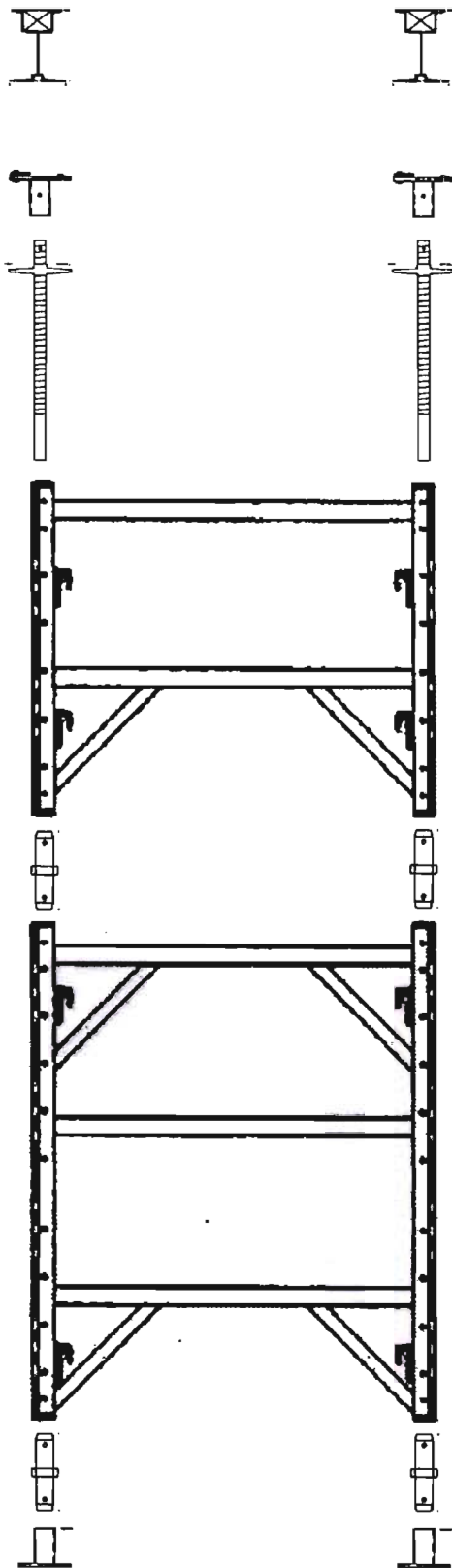

SH 40208  
 Top plate  
 Zone 40C

Folder: 08-02-29; SH 40208



SH40208\_2



SH40208\_4



SH40208\_1

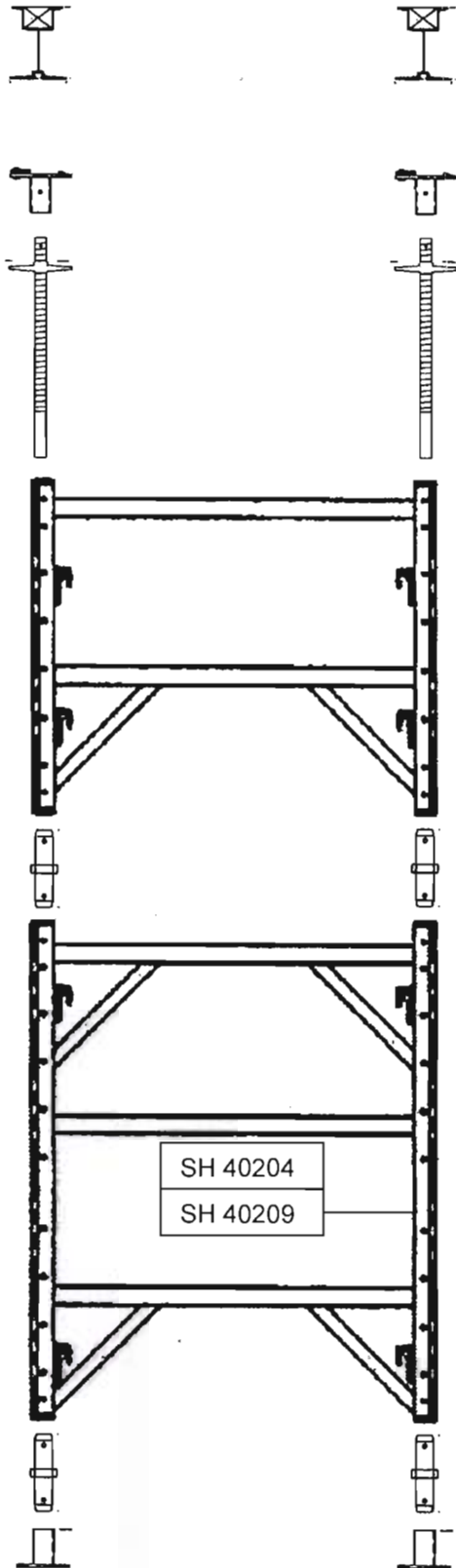

SH 40209  
 Piece of frame part of SH 40204  
 Zone 40C

Folder: 08-02-29; SH 40209



SH40209\_3



SH40209\_4



SH40209\_1

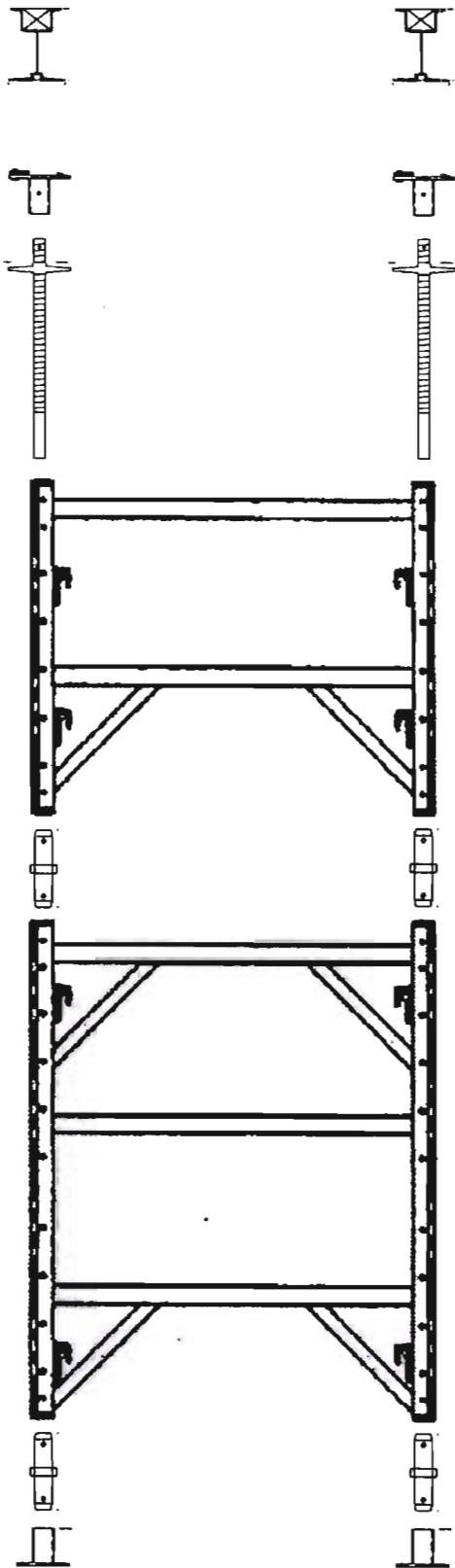

SH 40210  
 Top plate  
 Zone 40B

Folder: 08-02-29; SH 40210



SH40210\_2



SH40210\_3



SH40210\_1

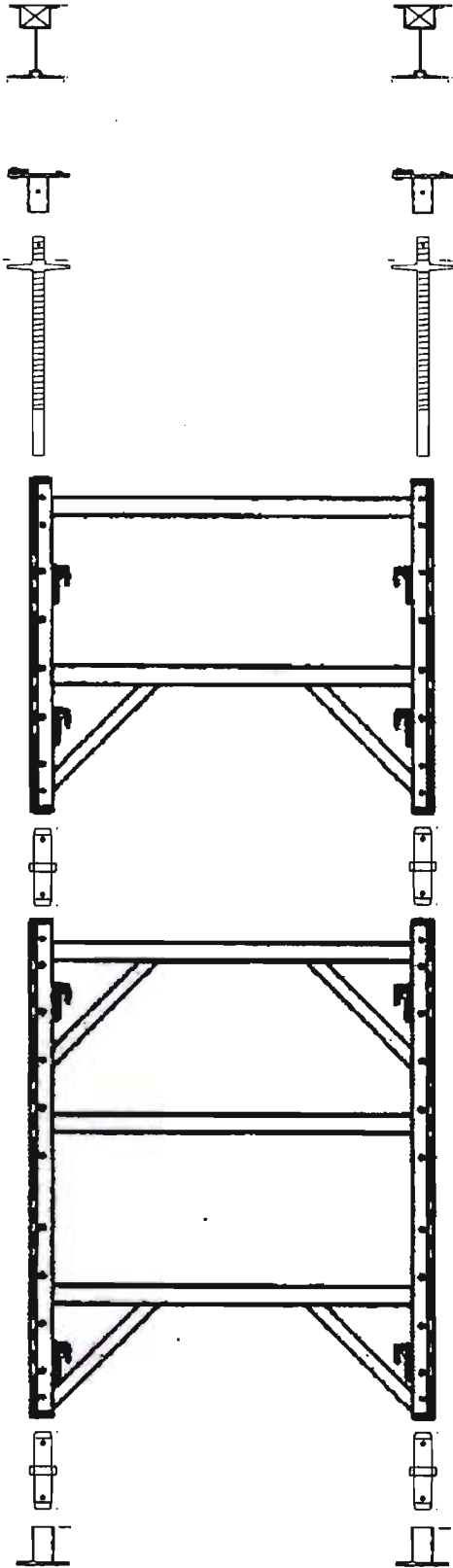

SH 40211  
 Screw Jack and Bottom plates for SH 40056  
 Zone 40B

Folder: 08-02-29; SH 40211



SH40211\_1



SH40211\_2



SH40211\_3



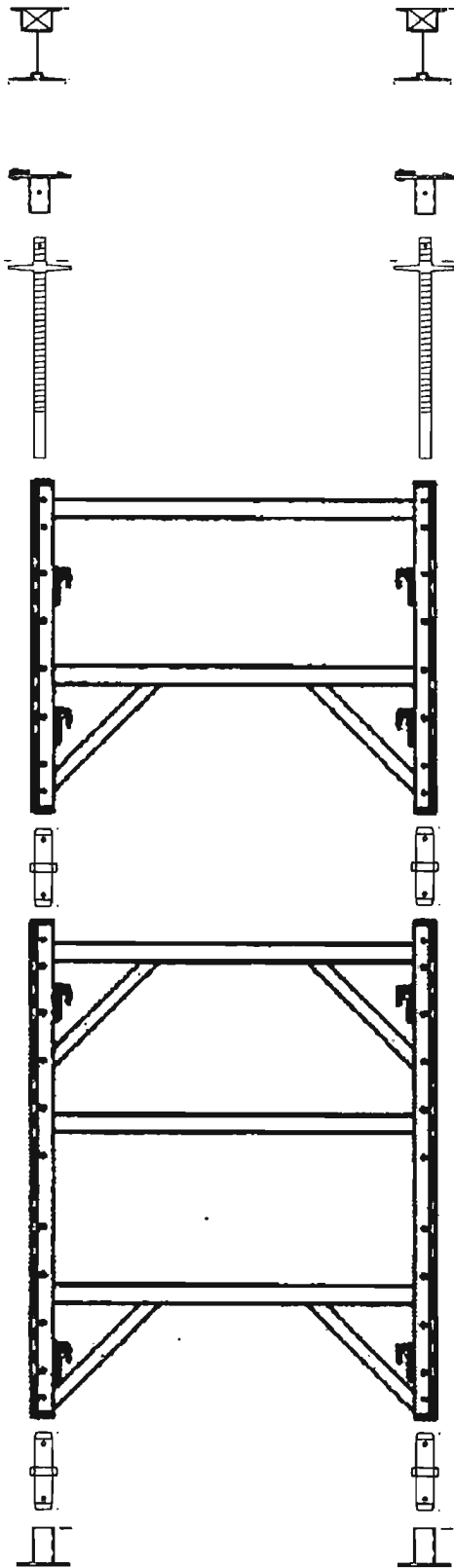

SH 40212  
 Screw Jack and Bottom plates of SH 40056  
 Zone 40B

Folder: 08-02-29; SH 40212



SH40212\_1



SH40212\_2



SH40213\_1

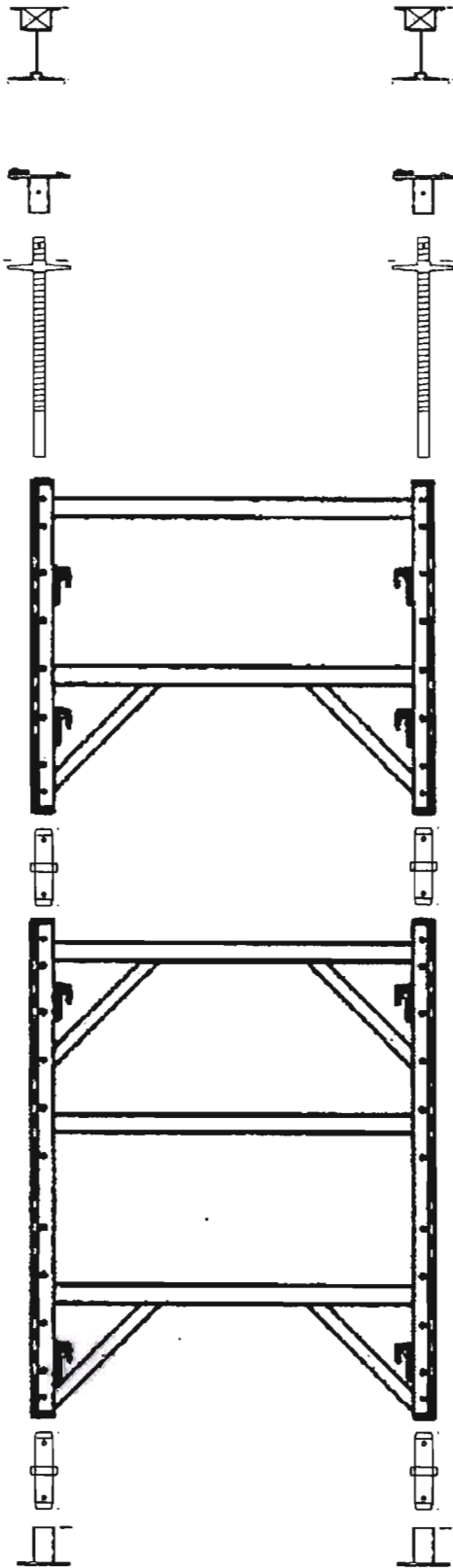

SH 40213  
Screw jack and Bottoms  
Zone 40B

Folder: 08-02-29; SH 40213



SH40213\_1



SH40213\_2



SH40213\_3

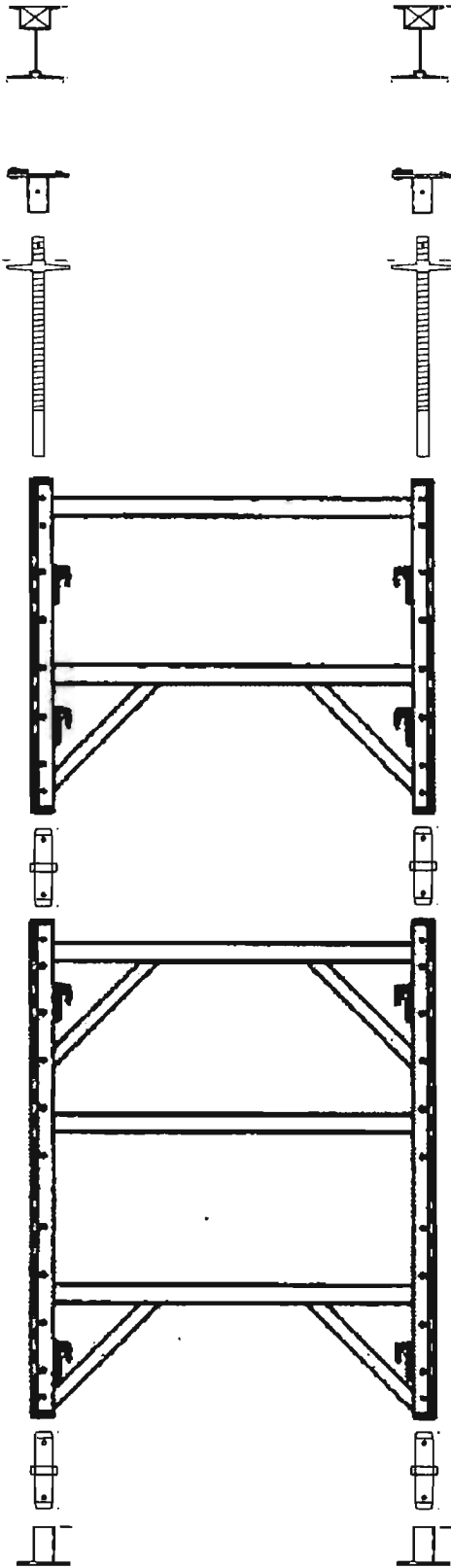

SH 40214  
 Screw jack and Bottom plates  
 Zone 40B

Folder: 08-02-29; SH 40214



SH40214\_1



SH40214\_2



SH40214\_3

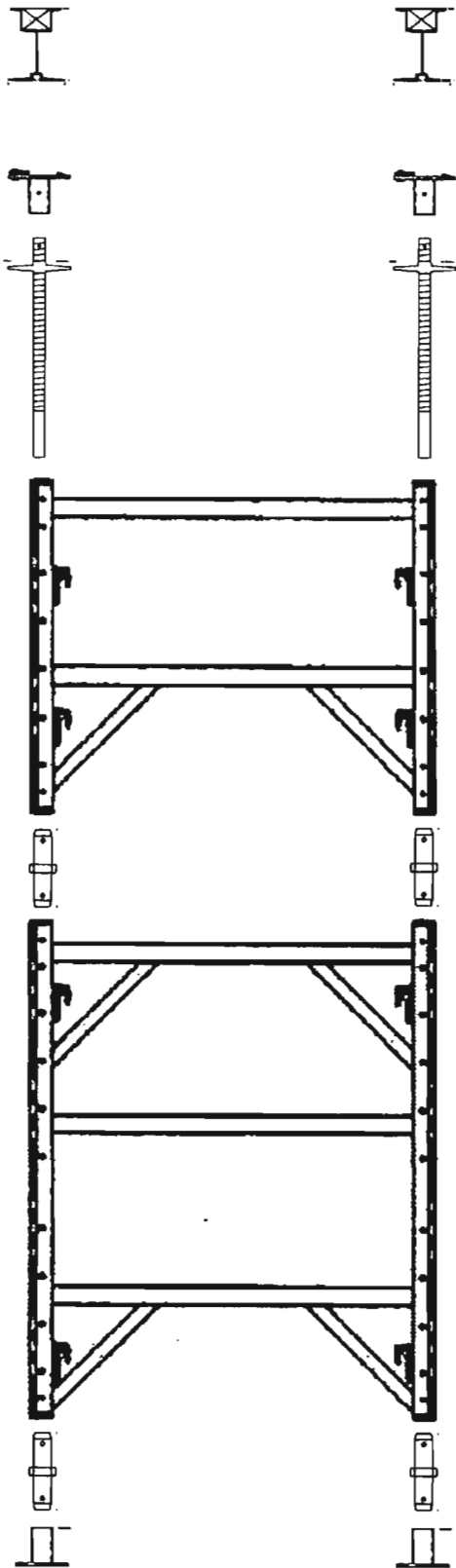

SH 40215  
Coupler  
Zone 40F-G

Folder: 08-02-29; SH 40215



SH40215\_3



SH40215\_1



SH40215\_2

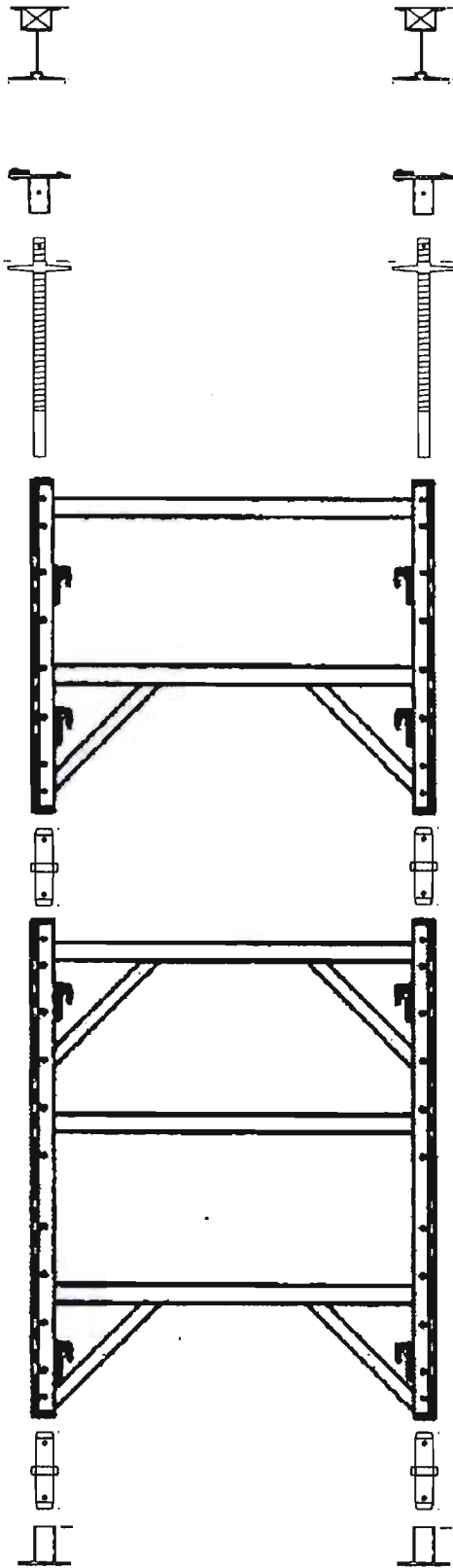

SH 40216  
Bottom plate  
Zone 40B

Folder: 08-02-29; SH 40216



SH40216\_3



SH40216\_1



SH40216\_2

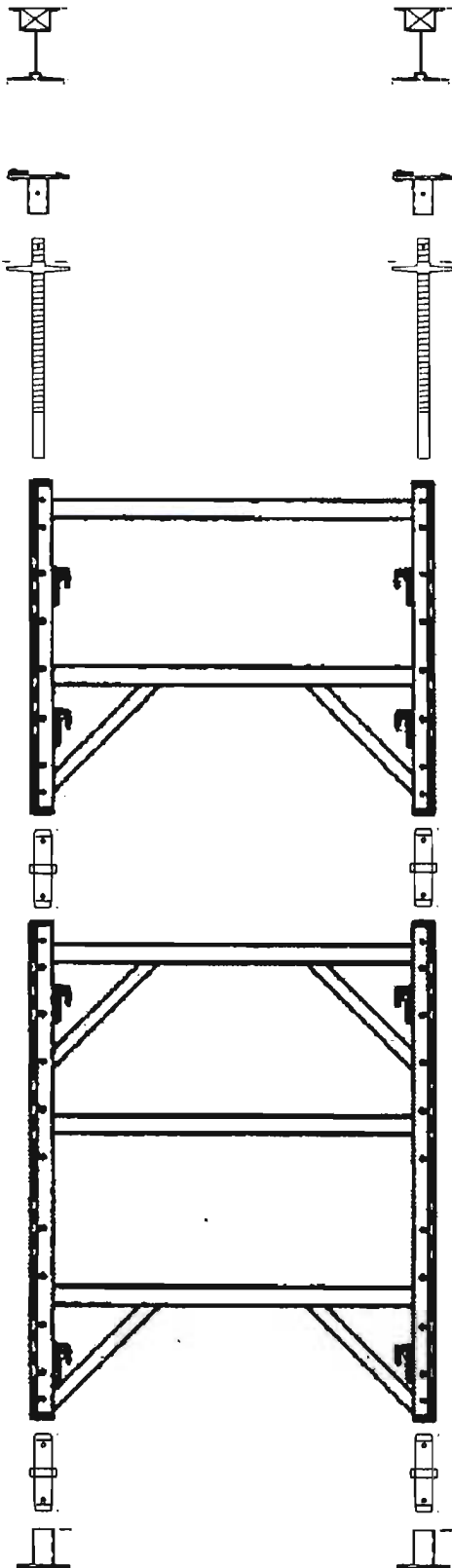

SH 40217  
 Top plate  
 Zone 40B

Folder: 08-03-03; SH 40217



SH40217\_1



SH40217\_3



SH40217\_4

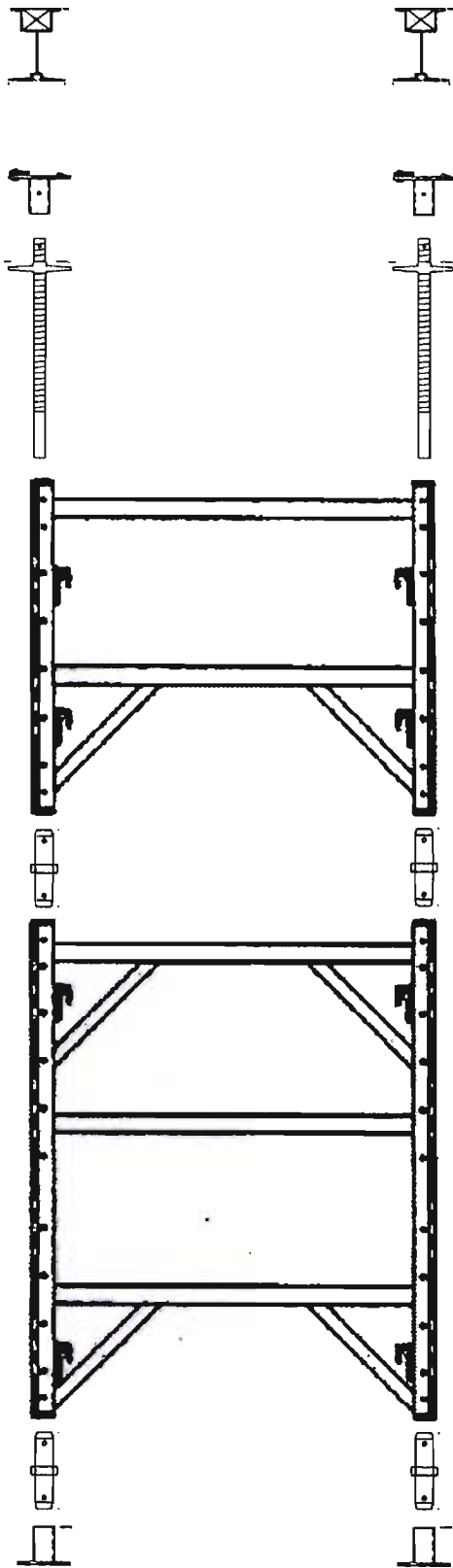

SH 40218  
 Piece of frame SH 40198  
 Zone 40B

Folder: 08-03-03; SH 40218

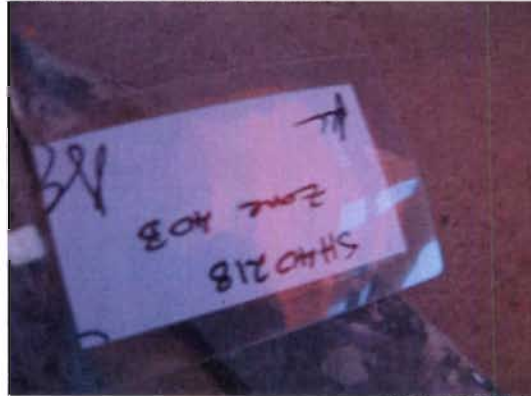

SH40218\_3



SH40218\_4



SH40218\_1

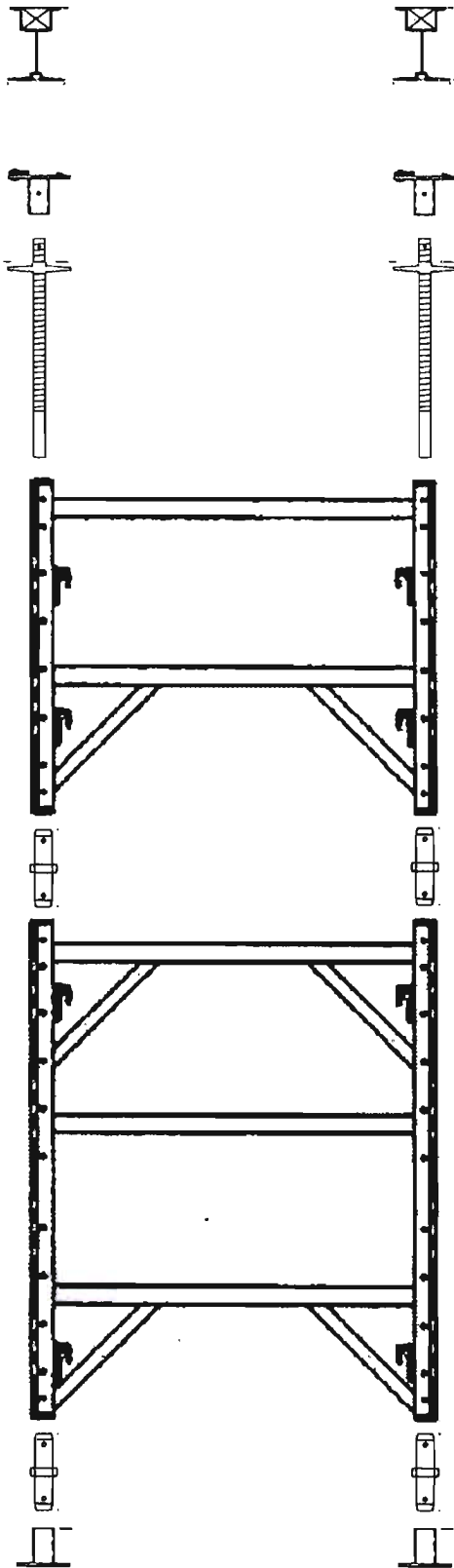

SH 40219  
 Piece of frame  
 Zone 40B

Folder: 08-03-03; SH 40219

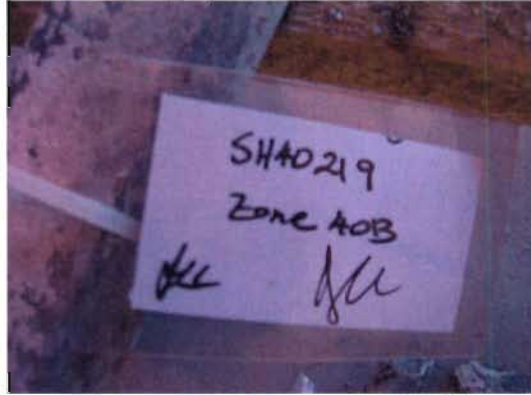

SH40219\_5



SH40219\_3

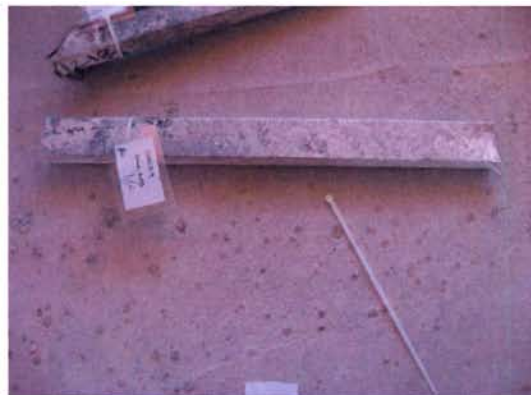

SH40219\_4



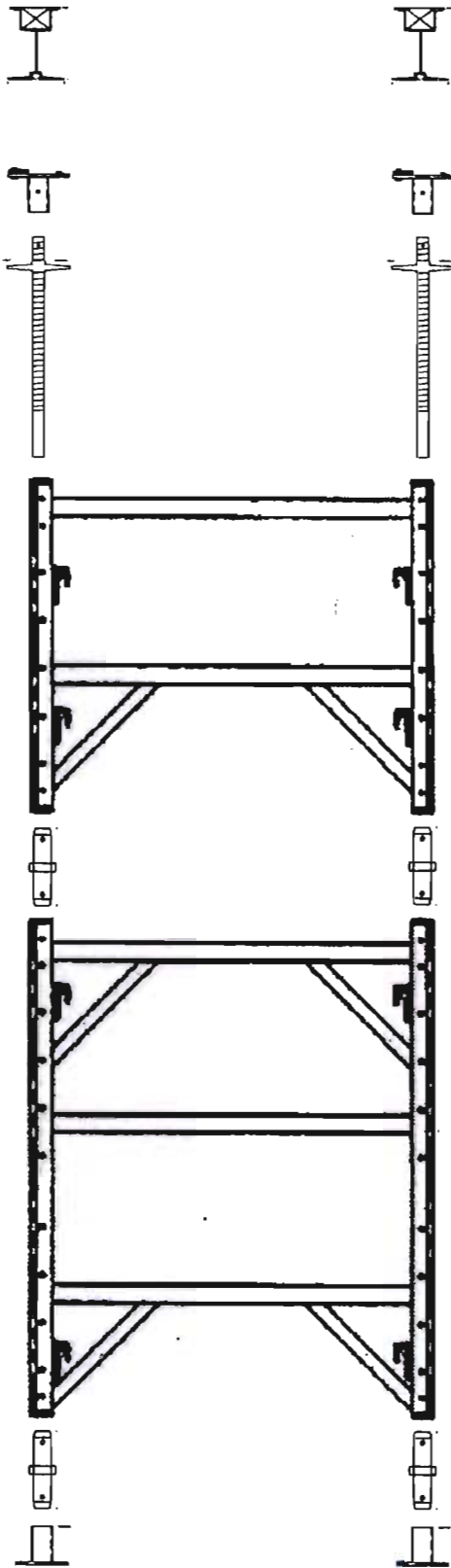

SH 40220  
 Bottom plate  
 Zone 40B

Folder: 08-03-03; SH 40220



SH40220\_6

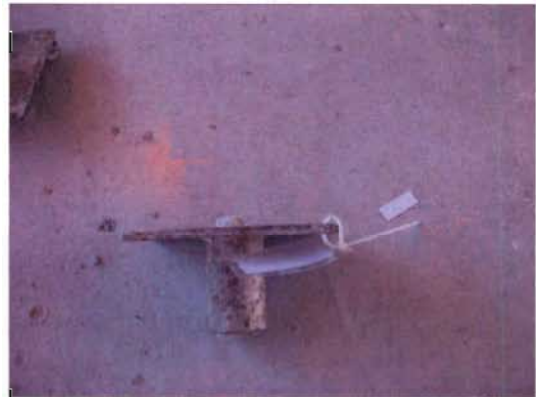

SH40220\_3



SH40220\_1

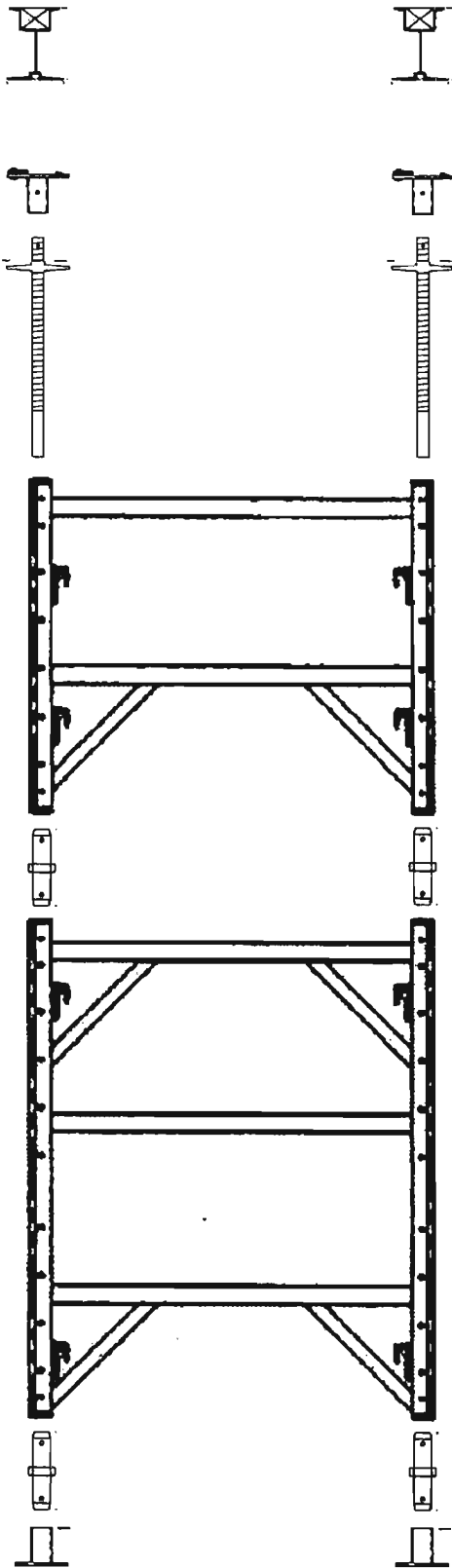

SH 40221  
 To plate  
 Zone 40B

Folder: 08-03-03; SH 40221



SH40221\_4



SH40221\_2



SH40221\_3

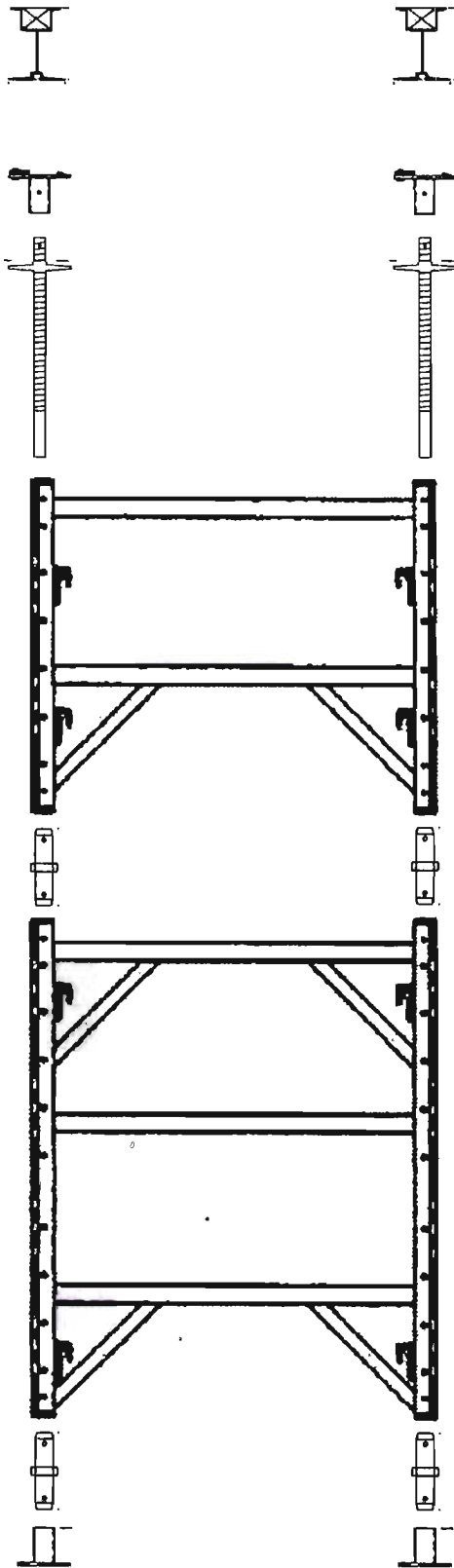

SH 40222  
 Piece of frame  
 Zone 40B

Folder: 08-03-03; SH 20222



SH40222\_4



SH40222\_3



SH40222\_1

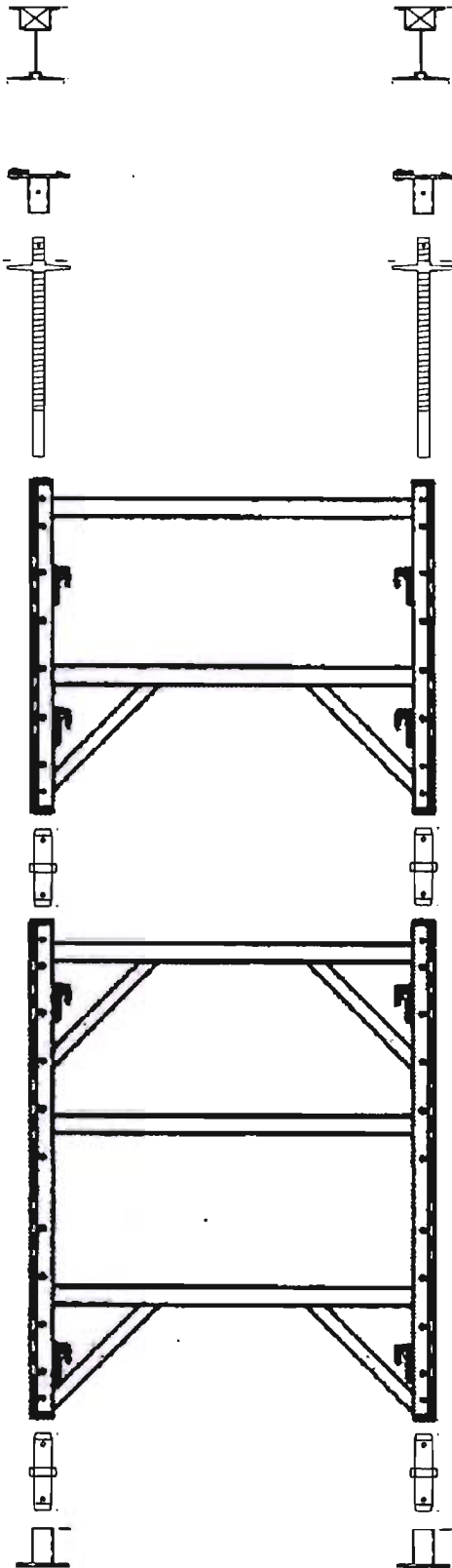

SH 40223  
 Piece of frame  
 Zone 40C

Folder: 08-03-03; SH 40223



SH40223\_1



SH40223\_2



SH40223\_3

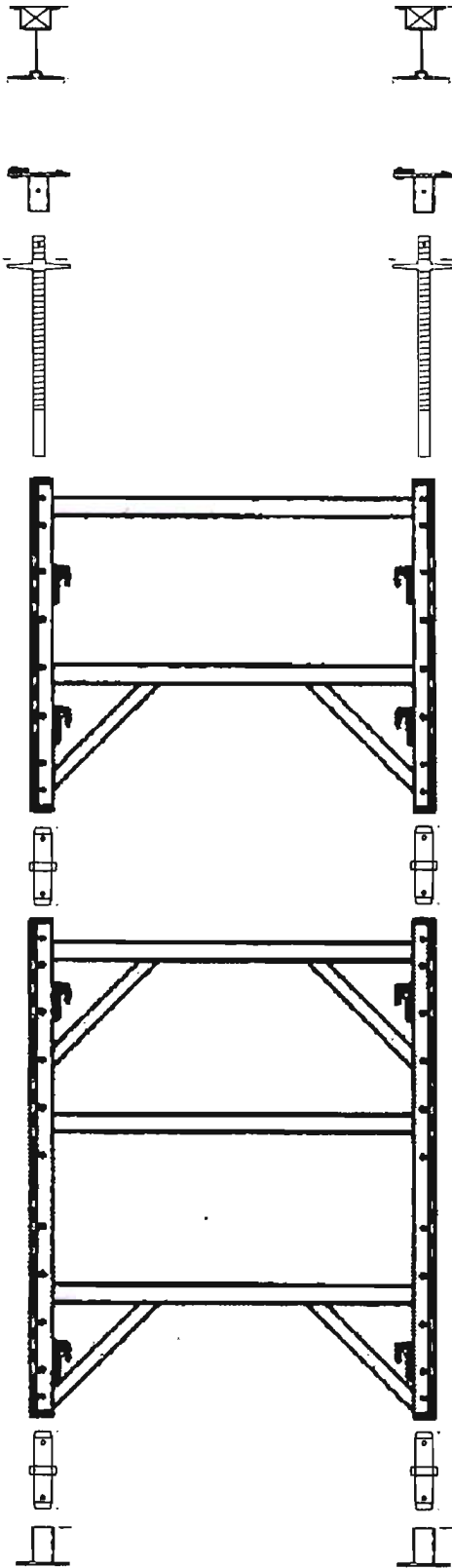

SH 40224  
 Piece of frame  
 Zone 40B

Folder: 08-03-03; SH 40224



SH40224\_1



SH40224\_2

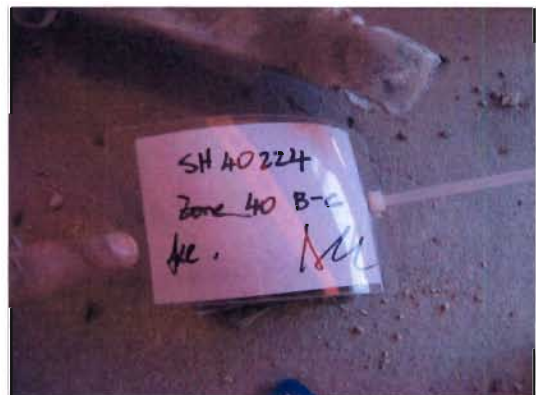

SH40224\_3

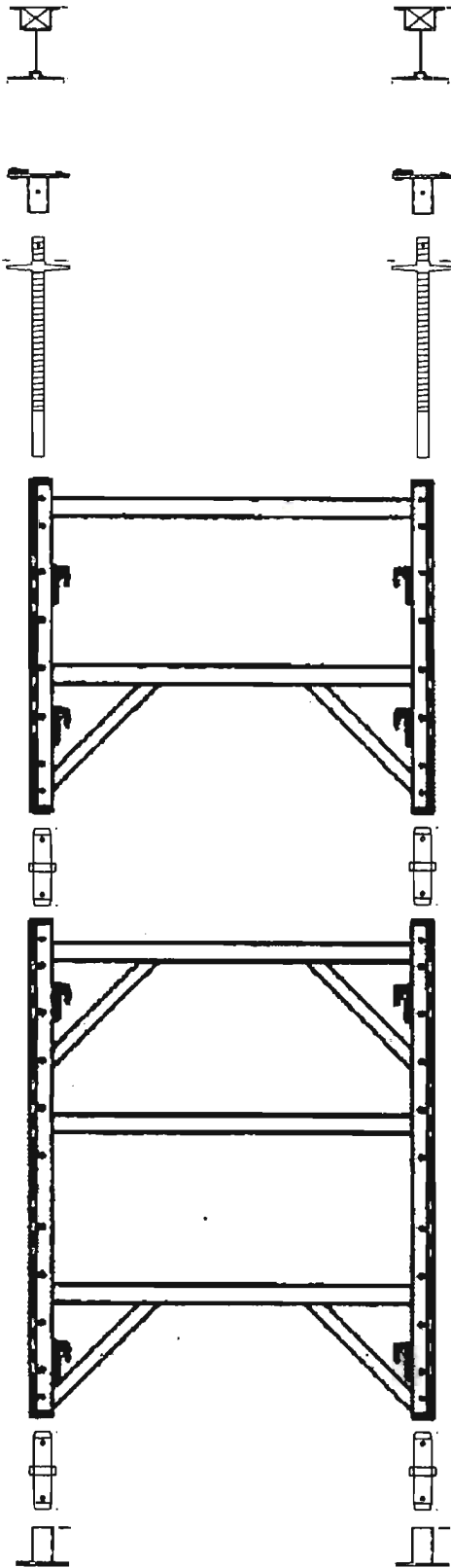

SH 40225  
 Clip left behind in staging area

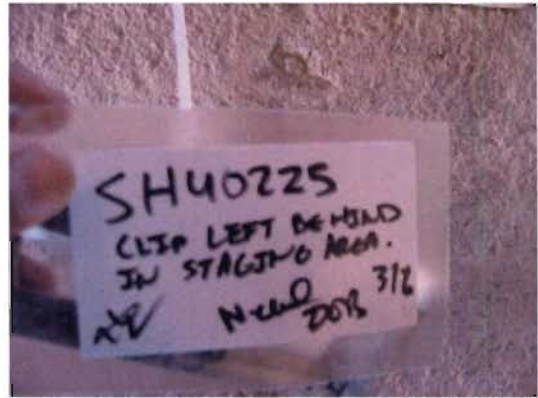

SH40225\_1



SH40225\_2

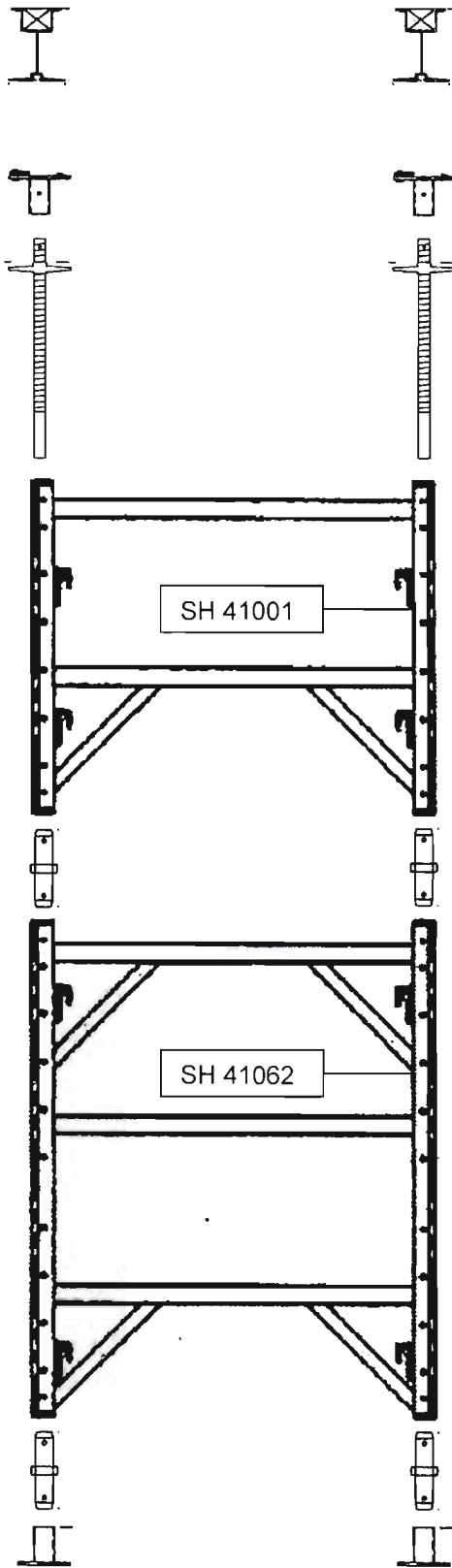

SH 41001  
 Top Frame  
 Bottom Frame SH 41062  
 Connect to SH 41002  
 Zone 41K

Folder: 08-01-29 (updated 08-02-04 & 08-02-05); 41st floor; SH



SH41001\_1



SH41001\_3



SH41001\_4

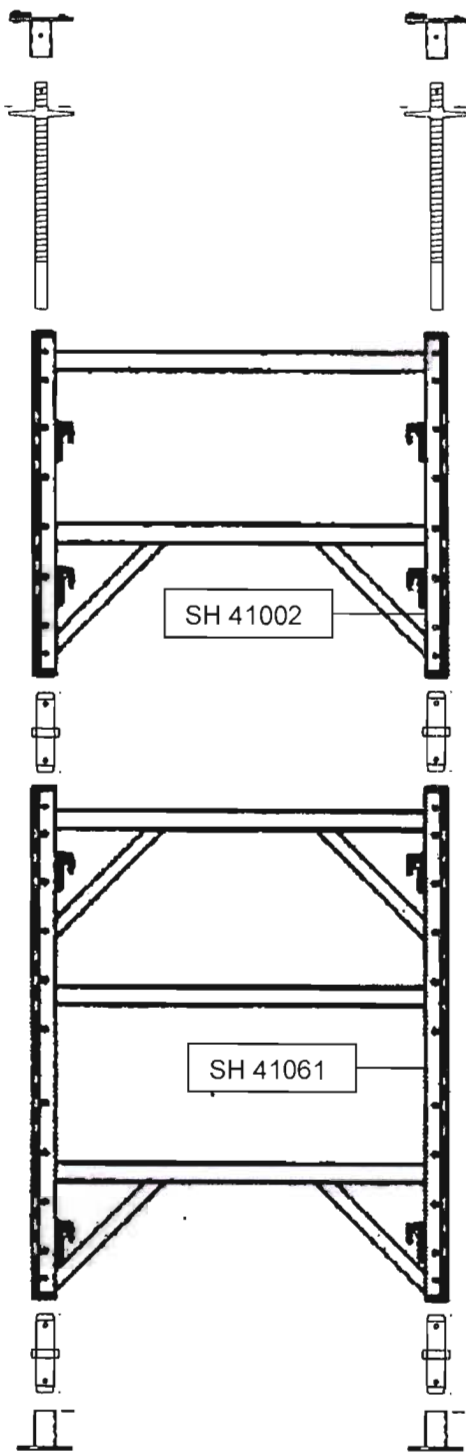

SH 41002  
 Top Frame  
 Bottom Frame SH 41061  
 Connect to SH 41001(Tower)  
 Zone 41K

Folder: 08-01-29 (updated 08-02-04 & 08-02-05); 41st floor; SH 41002



SH41002\_1



SH41002\_3



SH41002\_4



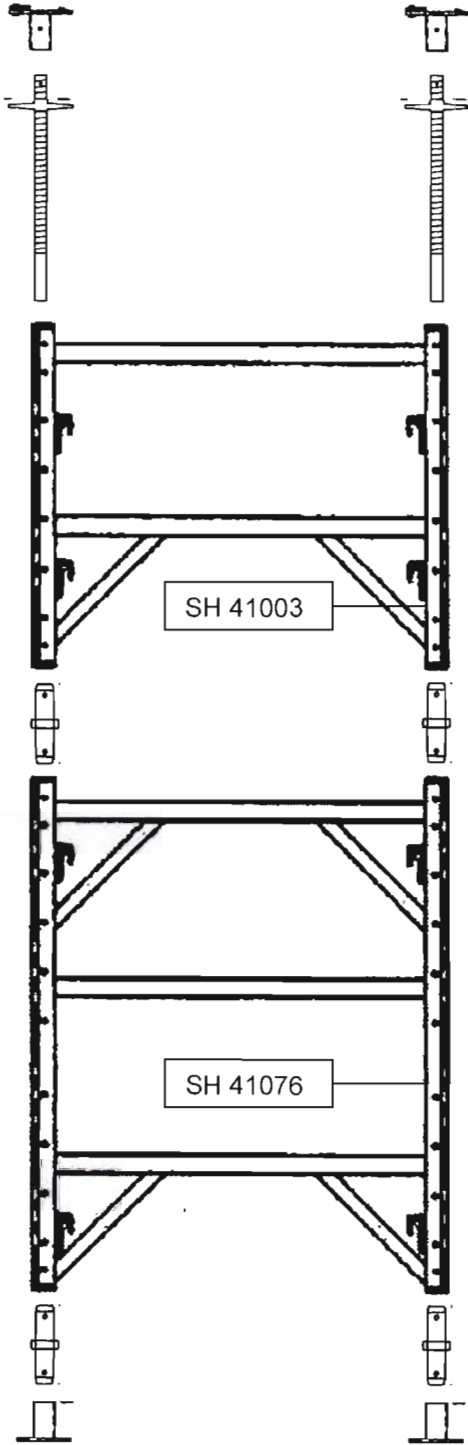

SH 41003  
 Top Frame  
 Bottom Frame SH 41026  
 Connect to top SH 41004(Tower)  
 Zone 41K-J

Folder: 08-01-29 (updated 08-02-04 & 08-02-05); 41st floor: SH 41003

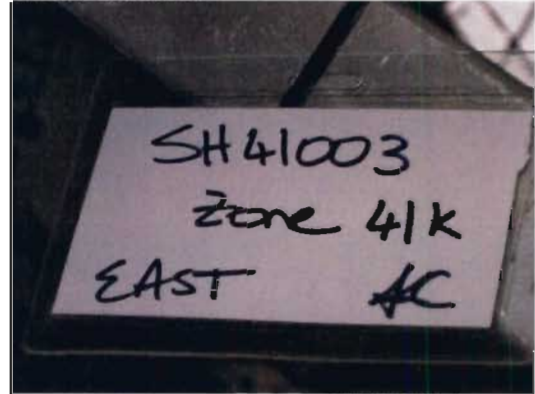

SH41003\_1



SH41003\_3



SH41003\_5

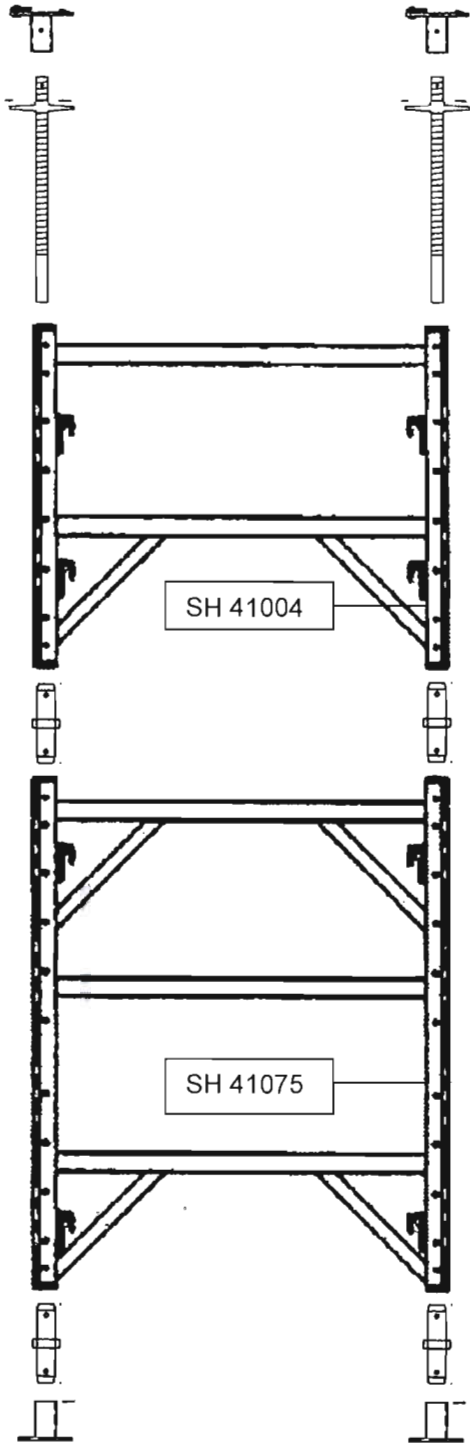

SH 41004  
 Top Frame  
 Bottom Frame SH 41075  
 Connect to top SH 41003  
 Zone 41K

Folder: 08-01-29 (updated 08-02-04 & 08-02-05); 41st floor; SH 401004



SH41004\_2



SH41003\_4



SH41004\_3

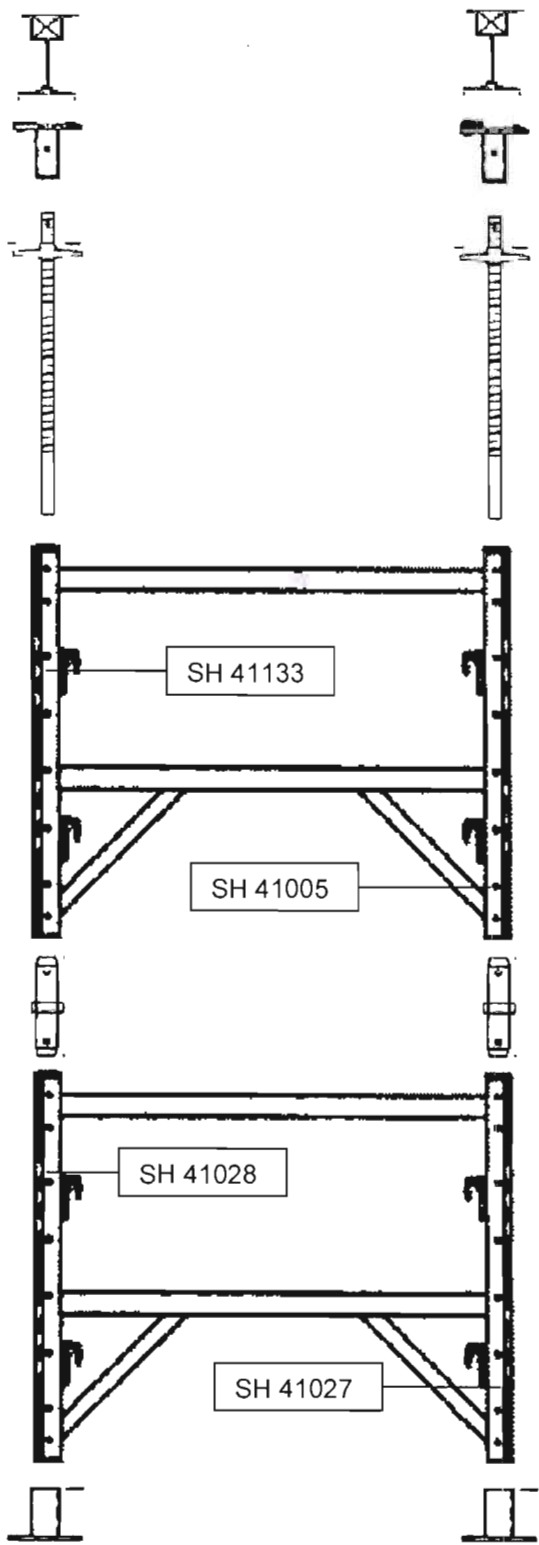

SH 41005  
 Broken Top Frame  
 Bottom Frame SH 41027 and SH 41028  
 Supports AB 41004  
 Zone 41G

Folder: 08-01-29 (updated 08-02-04 & 08-02-05); 41st floor; SH 41005

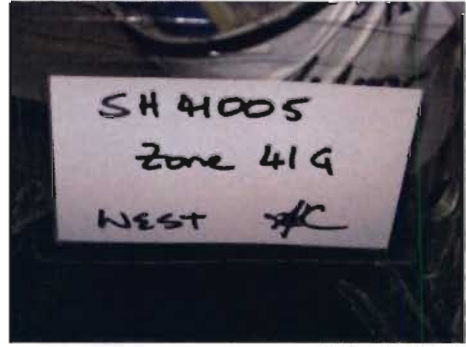

SH41005\_1



SH41005\_2



SH41005\_4

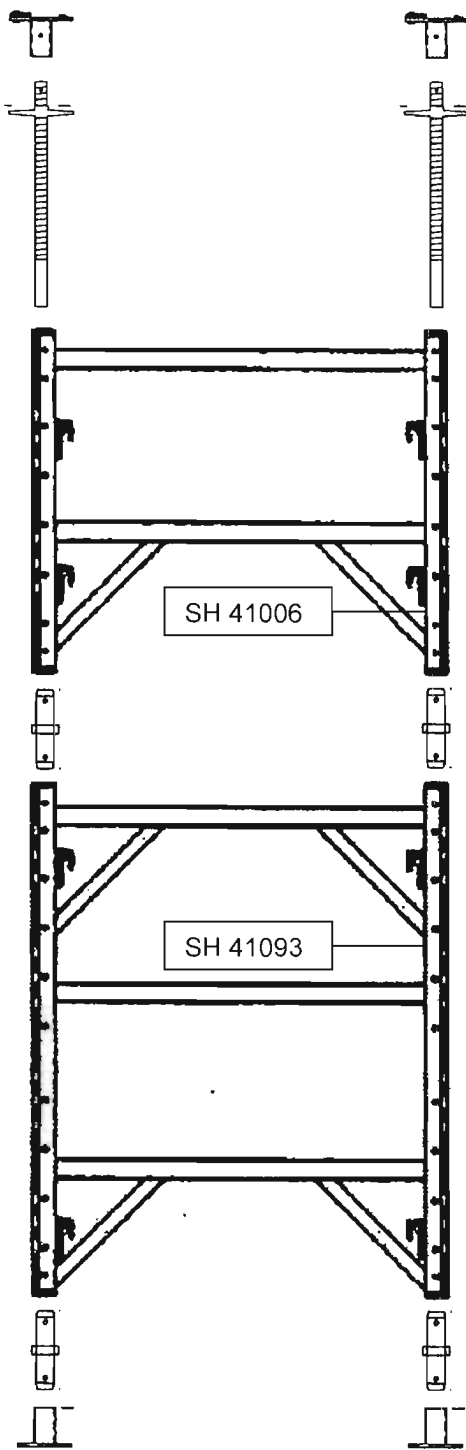

SH 41006  
 Top Frame  
 Bottom Frame SH 41093  
 Zone 41J

Folder: 08-01-29 (updated 08-02-04 & 08-02-05); 41st floor; SH 41006



SH41006\_1



SH41006\_3



SH41006\_5

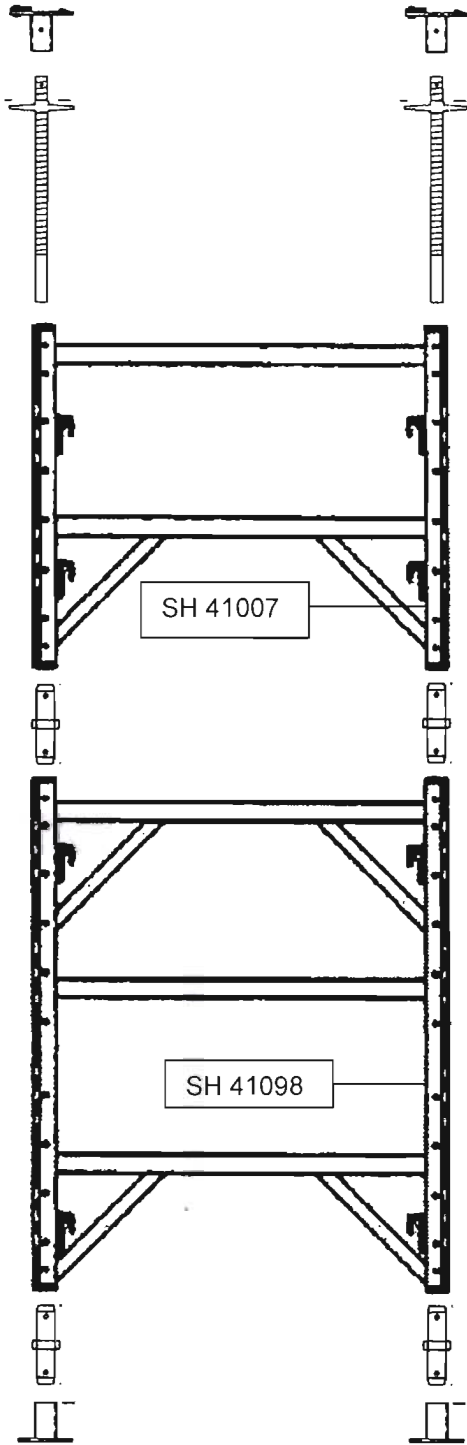

SH 41007  
 Top Frame  
 Bottom Frame SH 41098  
 Zone 41J

Folder: 08-01-29 (updated 08-02-04 & 08-02-05); 41st floor, SH 41007



SH41007\_2



SH41007\_4



SH41007\_5

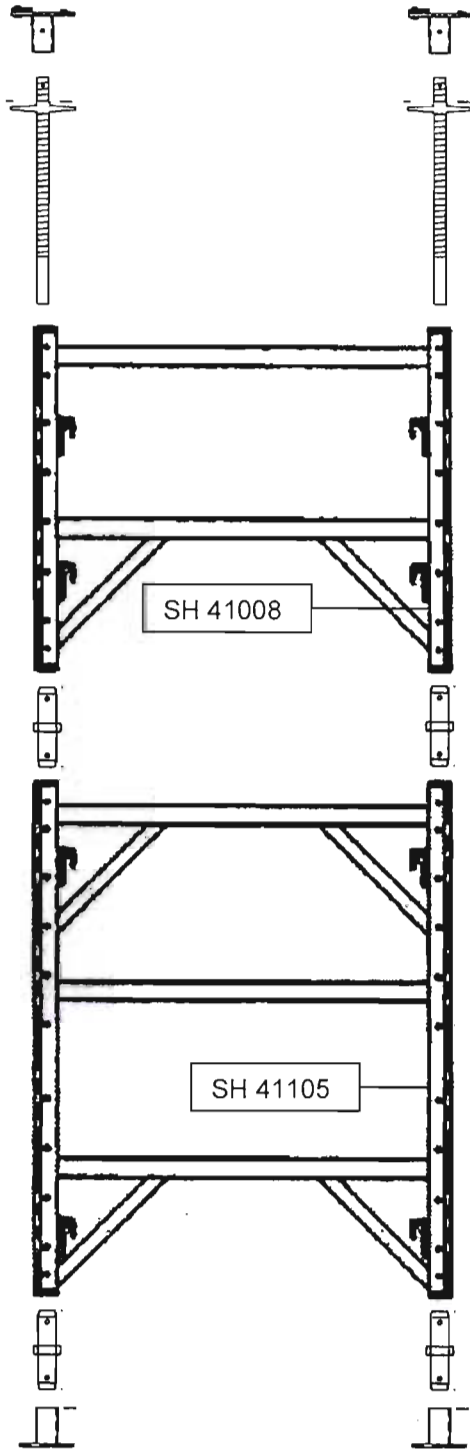

SH 41008  
 Top Frame  
 Bottom Frame SH 41105  
 Zone 41D-H

Folder: 08-01-29 (updated 08-02-04 & 08-02-05); 41st floor; SH 41008



SH41008\_2



SH41008 4



SH41008\_5

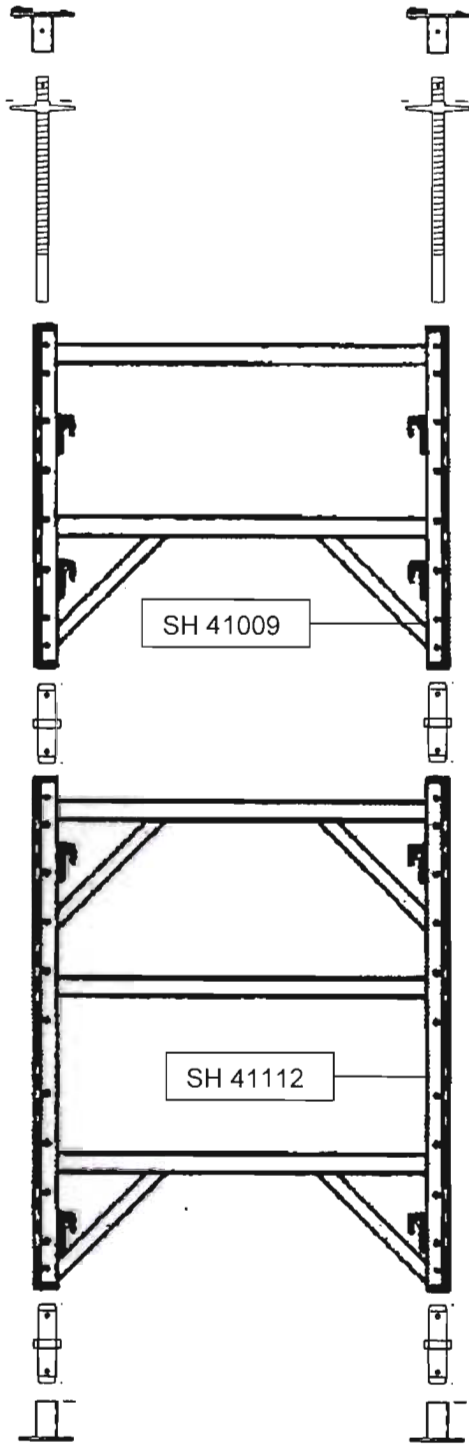

SH 41009  
 Top Frame  
 Bottom Frame SH 41112  
 Zone 41D

Folder: 08-01-29 (updated 08-02-04 & 08-02-05); 41st floor; SH 41009



SH41009\_2



SH41009\_1



SH41009\_6

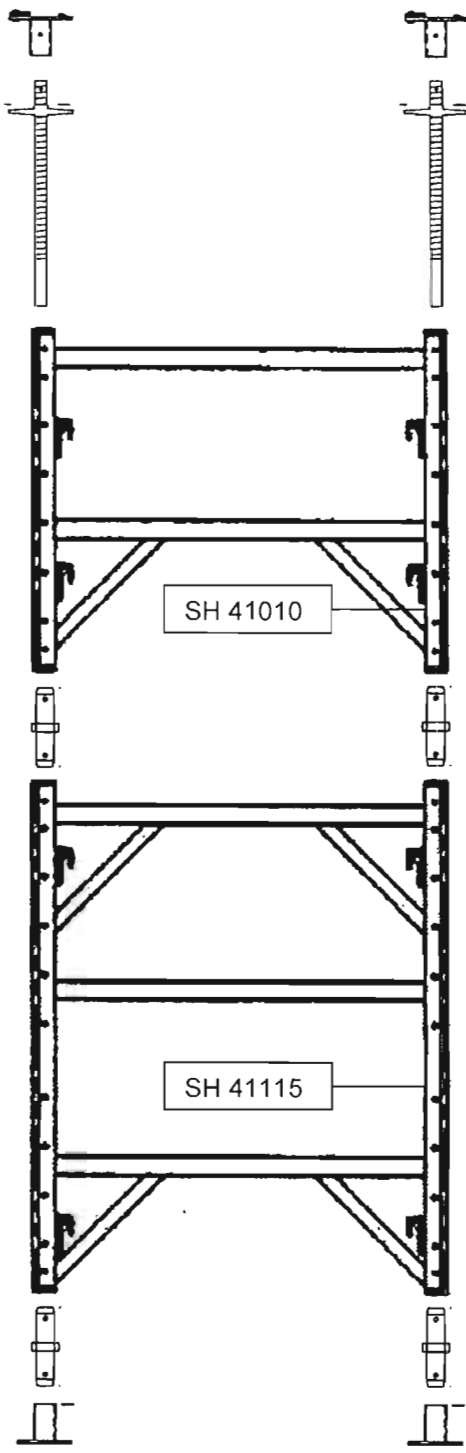

SH 41010  
 Top Frame  
 Bottom Frame SH 41115  
 Connect to Top SH 41009(Tower)  
 Zone 41D

Folder: 08-01-29 (updated 08-02-04 & 08-02-05); 41st floor; SH 41010



SH41010\_1



SH41010\_3



SH41010\_6



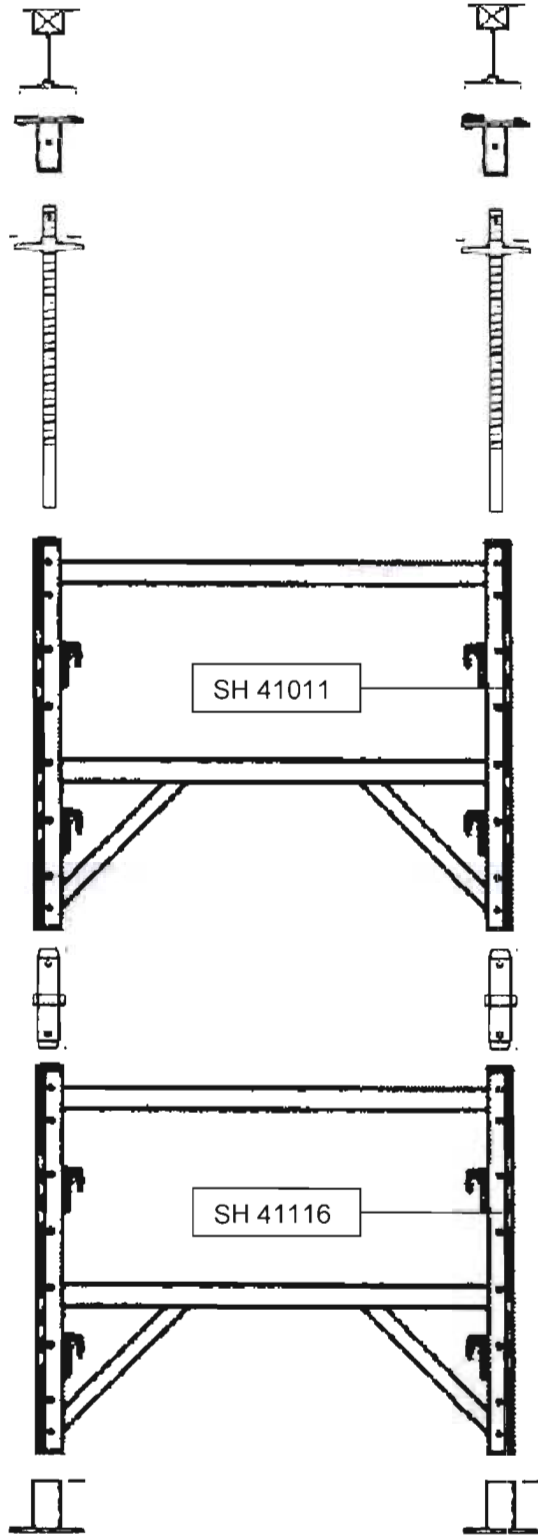

SH 41011  
 Top Frame  
 Bottom Frame SH 41116  
 Zone 41A  
 Folder: 08-01-29 (updated 08-02-04 & 08-02-05); 41st floor; SH



SH41011\_2



SH41011\_1



SH41011\_5

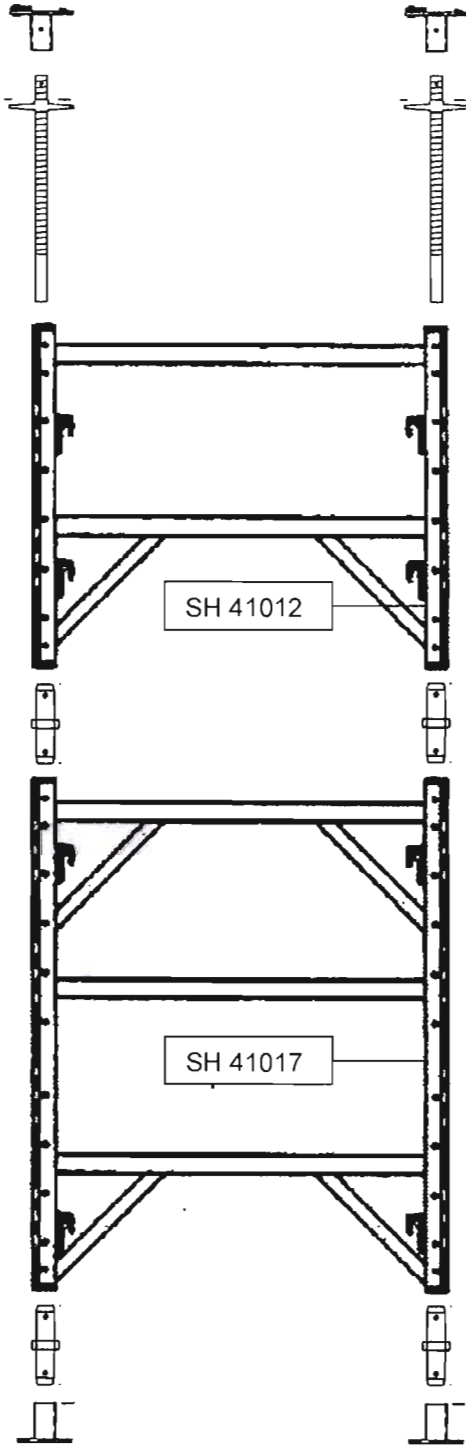

SH 41012  
 Top Frame  
 Bottom Frame SH 41017  
 Zone 41B

Folder: 08-01-29 (updated 08-02-04 & 08-02-05); 41st floor, SH 41012

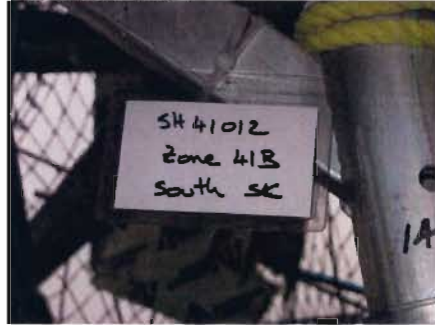

SH41012\_1



SH41012\_7



SH41012\_9

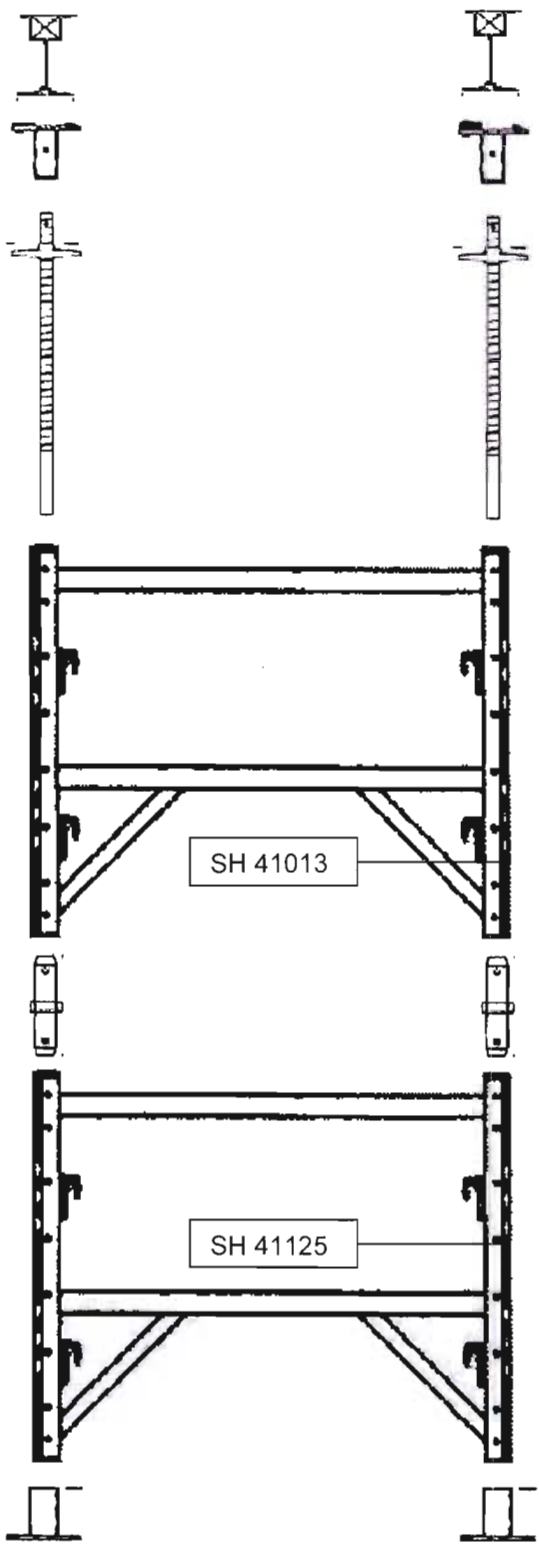

SH 41013  
 Top Frame  
 Bottom Frame SH 41125  
 Zone 41A-B

Folder: 08-01-29 (updated 08-02-04 & 08-02-05); 41st floor; SH 41013



SH41013\_1



SH41013\_5



SH41013\_7

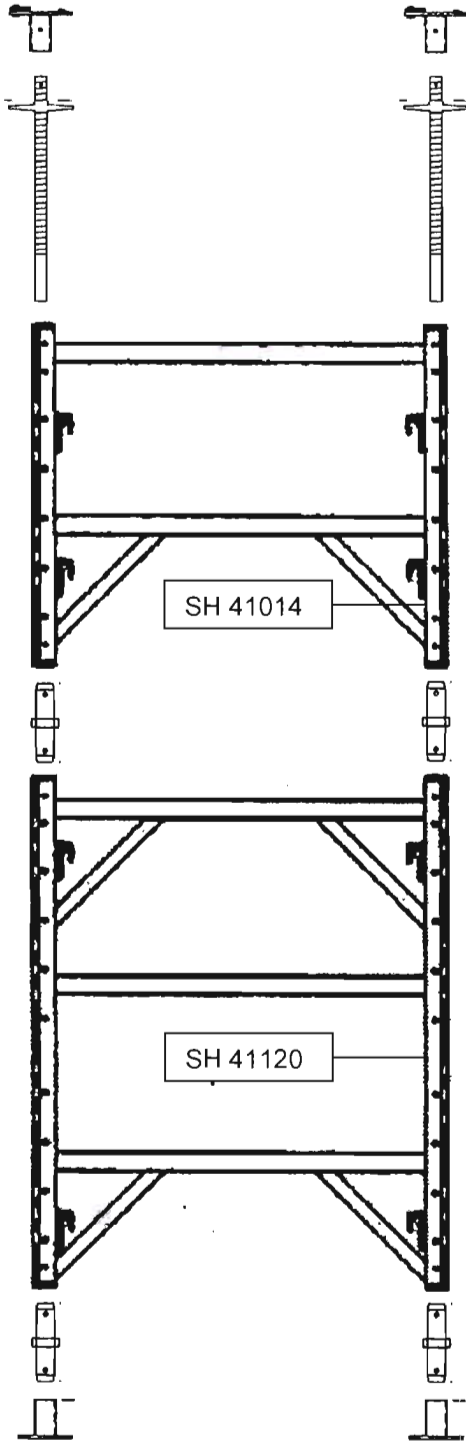

SH 41014  
Top Frame  
Bottom Frame SH 41120  
Zone 41A

Folder: 08-01-29 (updated 08-02-04 & 08-02-05); 41st floor; SH 41014



SH41014\_1



SH41014\_5

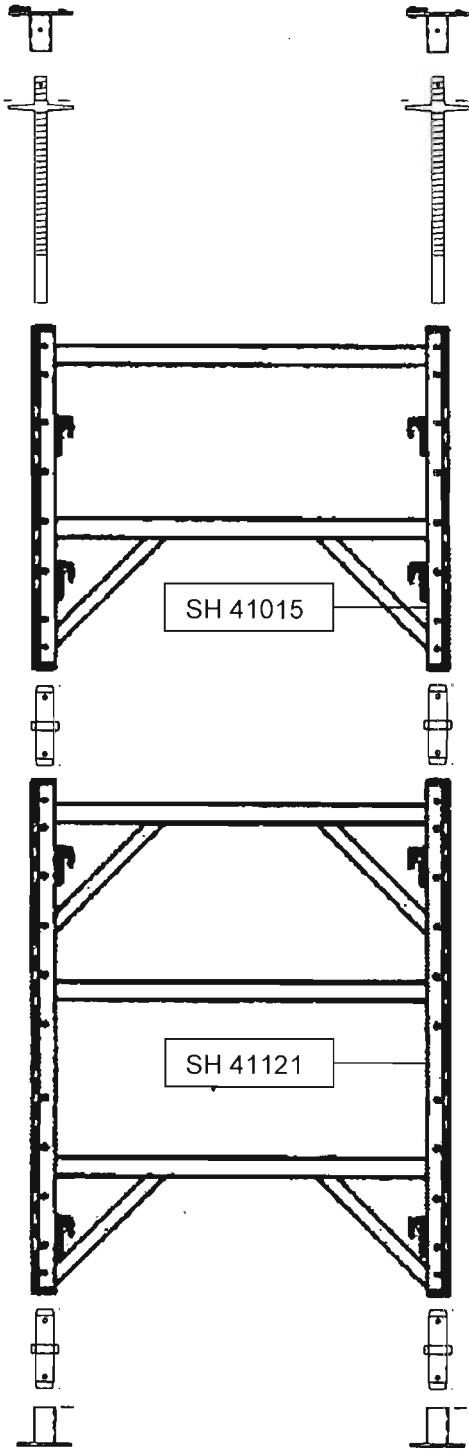

SH 41015  
 Top Frame  
 Bottom Frame SH 41121  
 Zone 41D

Folder: 08-01-29 (updated 08-02-04 & 08-02-05); 41st floor; SH 41015



SH41015\_1



SH41015\_5



SH41015\_6

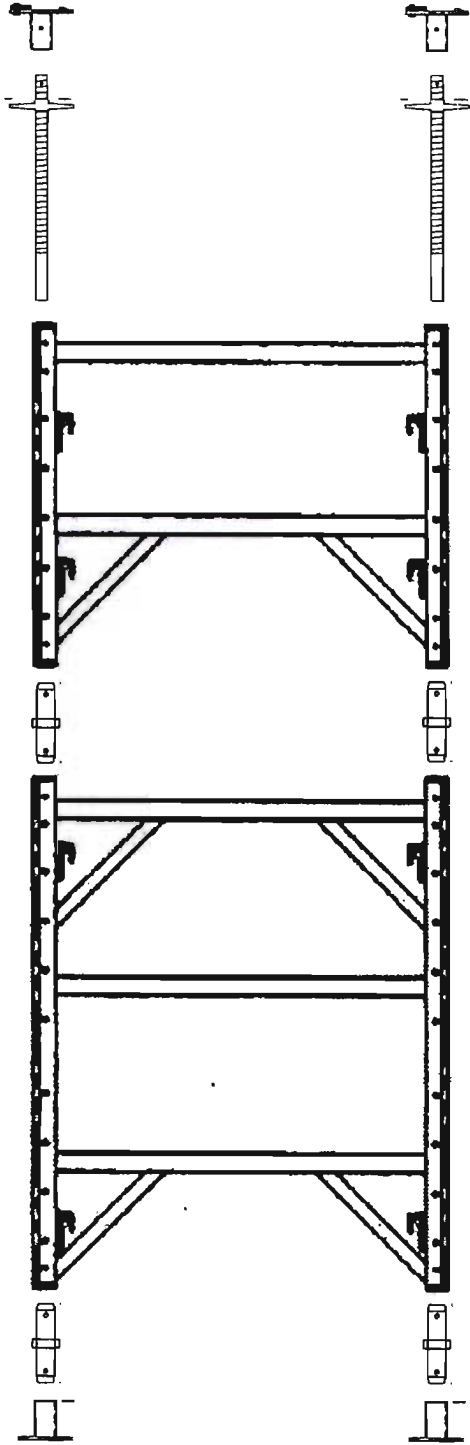

SH 41016  
X Brace  
Zone 41A

Folder: 08-02-06 to 08-02-08; SH 41016

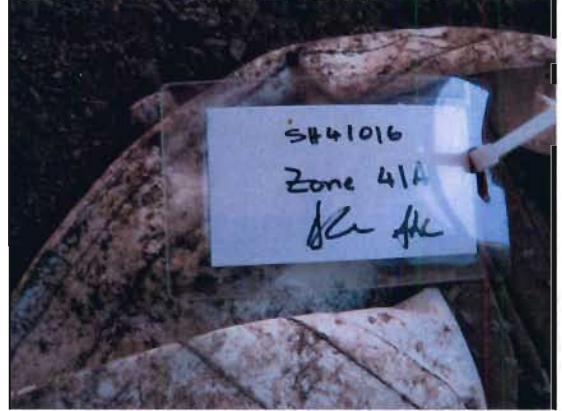

SH 41016 1



SH 41016 2

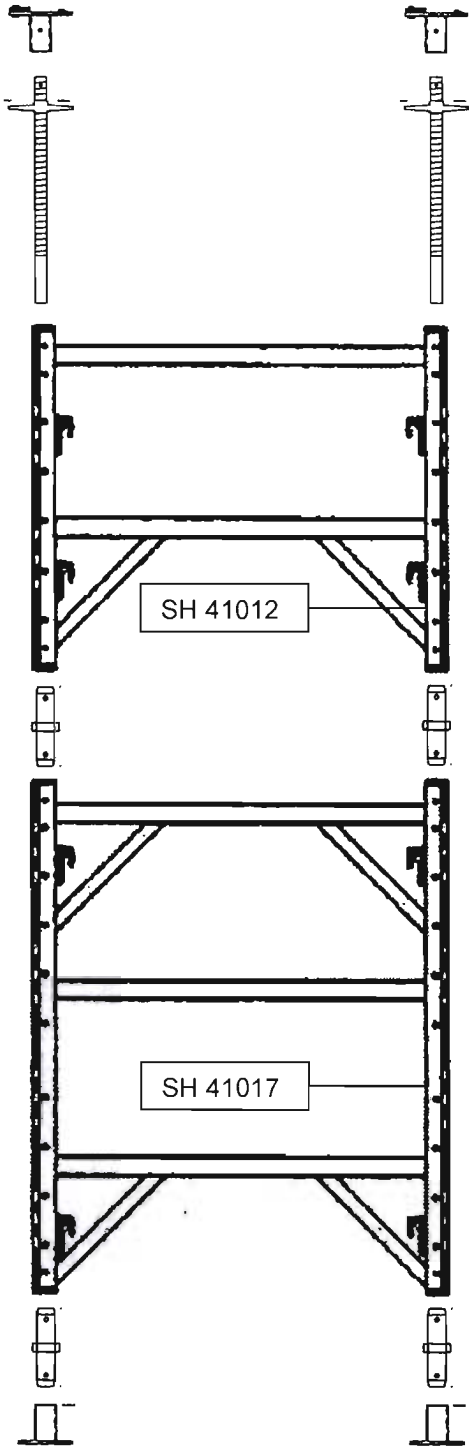

SH 41017  
Bottom of SH 41012  
Zone 41B

Folder: 08-02-06 to 08-02-08; SH 41017



SH 41017 1



SH 41017 2

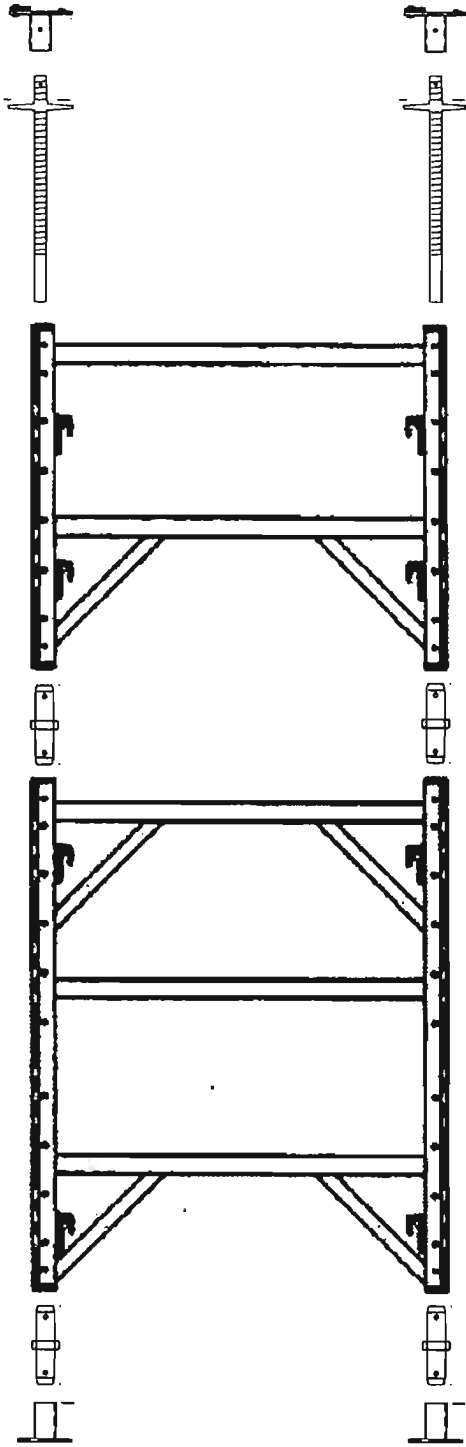

SH 41018  
Brace for SH 41017  
Zone 41B

Folder: 08-02-06 to 08-02-08; SH 41018



SH 41018 1



SH 41018 3



SH 41018 2



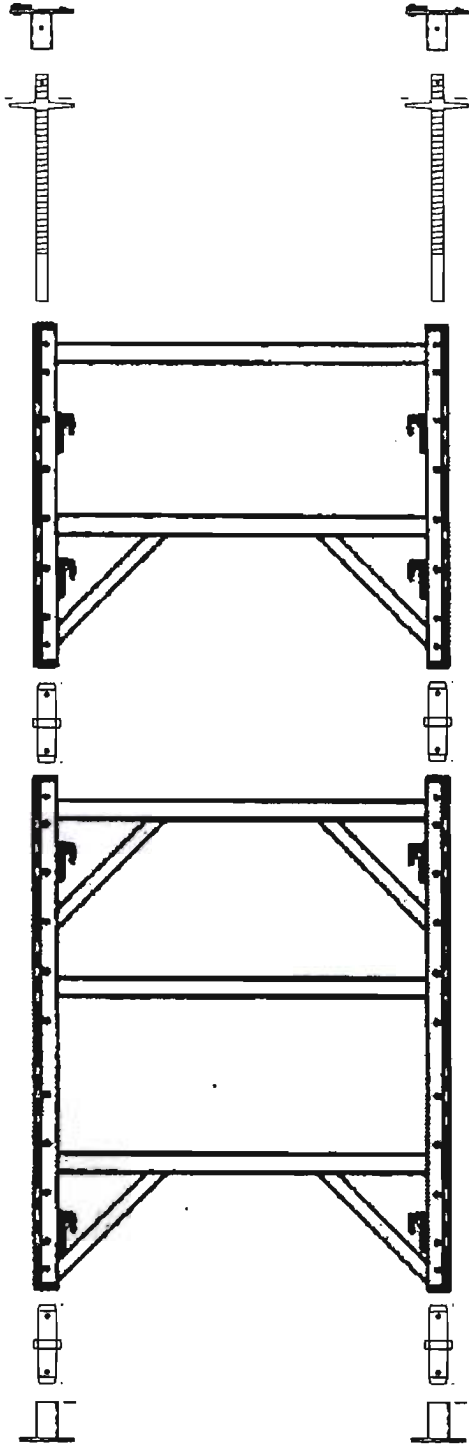

SH 41019  
 Top brace  
 Connect to SH 41012  
 Zone 41B

Folder: 08-02-06 to 08-02-08; SH 41019



SH 41019 1



SH 41019 2



SH 41019 3

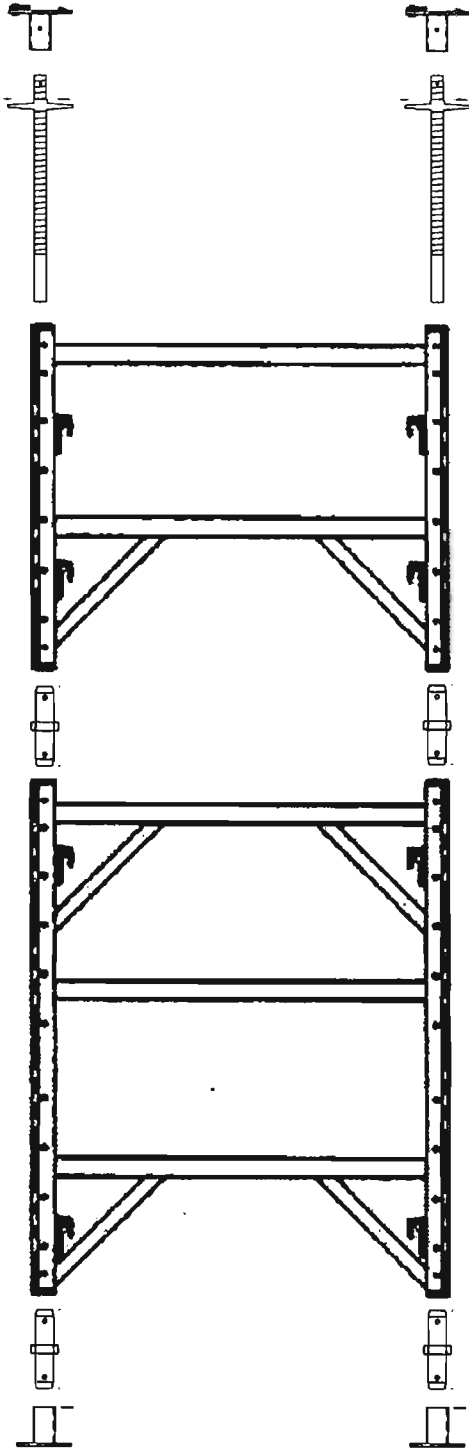

SH 41020  
Bottom Brace  
Attached to SH 41017 & SH 41039  
Zone 41B

Folder: 08-02-06 to 08-02-08; SH 41020



SH 41020 1



SH 41020 2



SH 41020 3

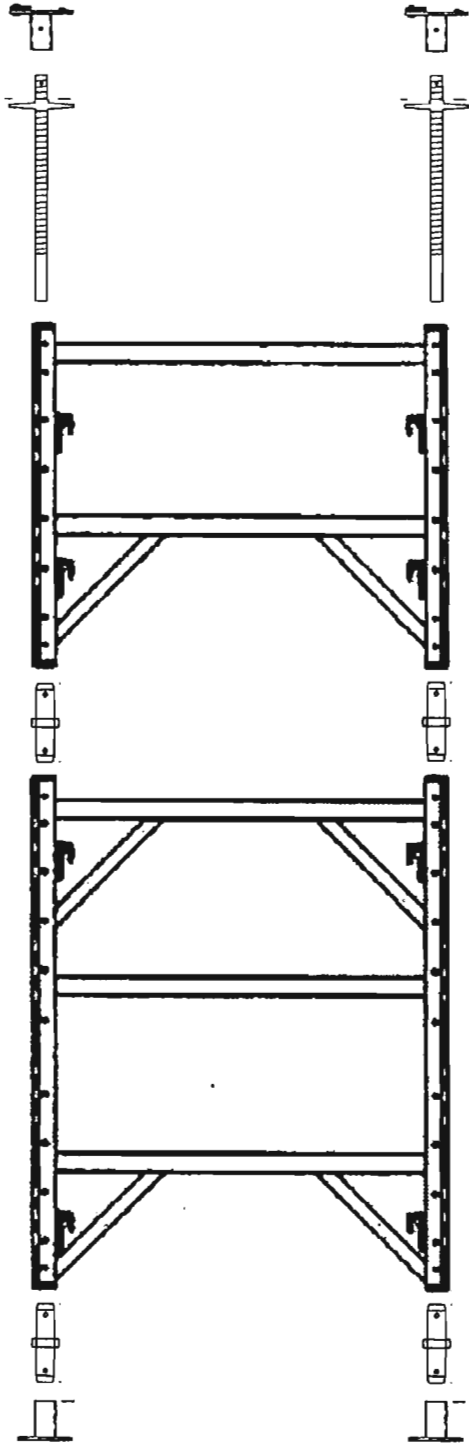

SH 41021  
Top brace  
Attached to SH 41012  
Zone 41B

Folder: 08-02-06 to 08-02-08; SH 41021



SH 41021 1



SH 41021 2

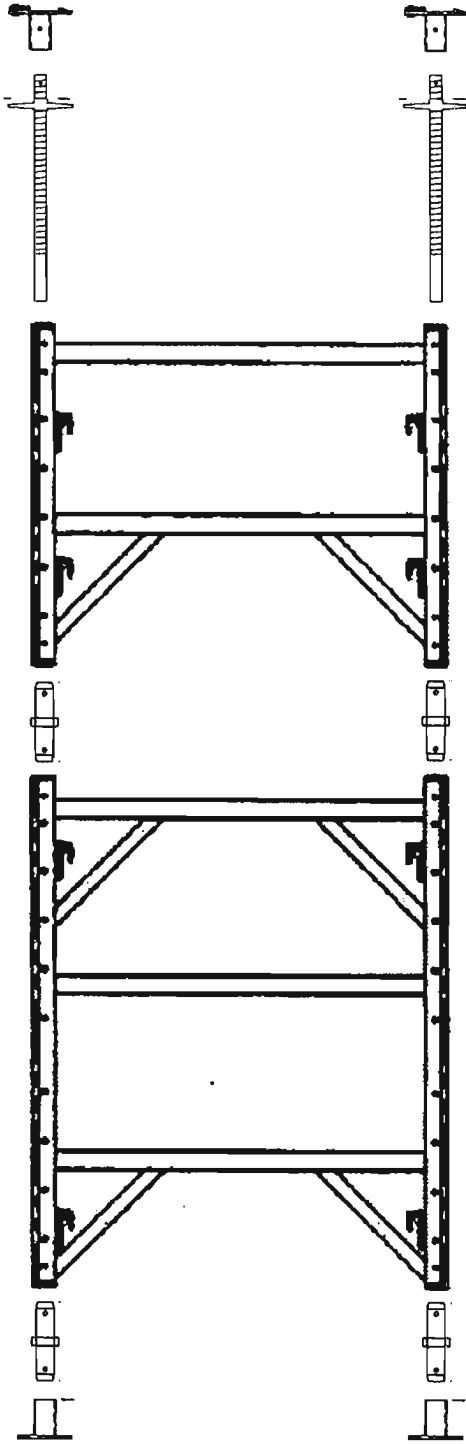

SH 41022  
Brace  
Zone 41B

Folder: 08-02-06 to 08-02-08; SH 41022



SH 41022 1



SH 41022 2

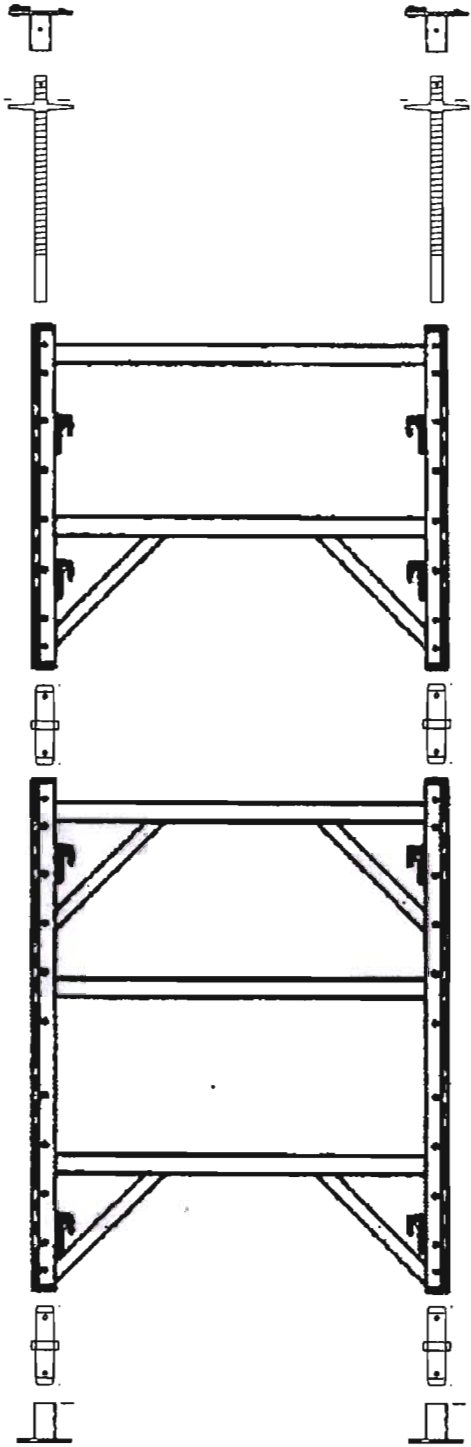

SH 41023  
Brace  
Zone 41B

Folder: 08-02-06 to 08-02-08; SH 41023

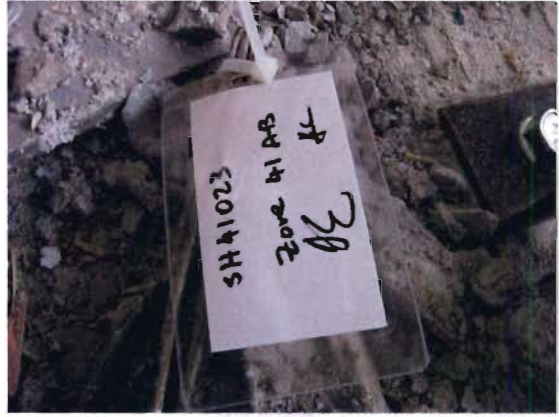

SH 41023 1



SH 41023 2

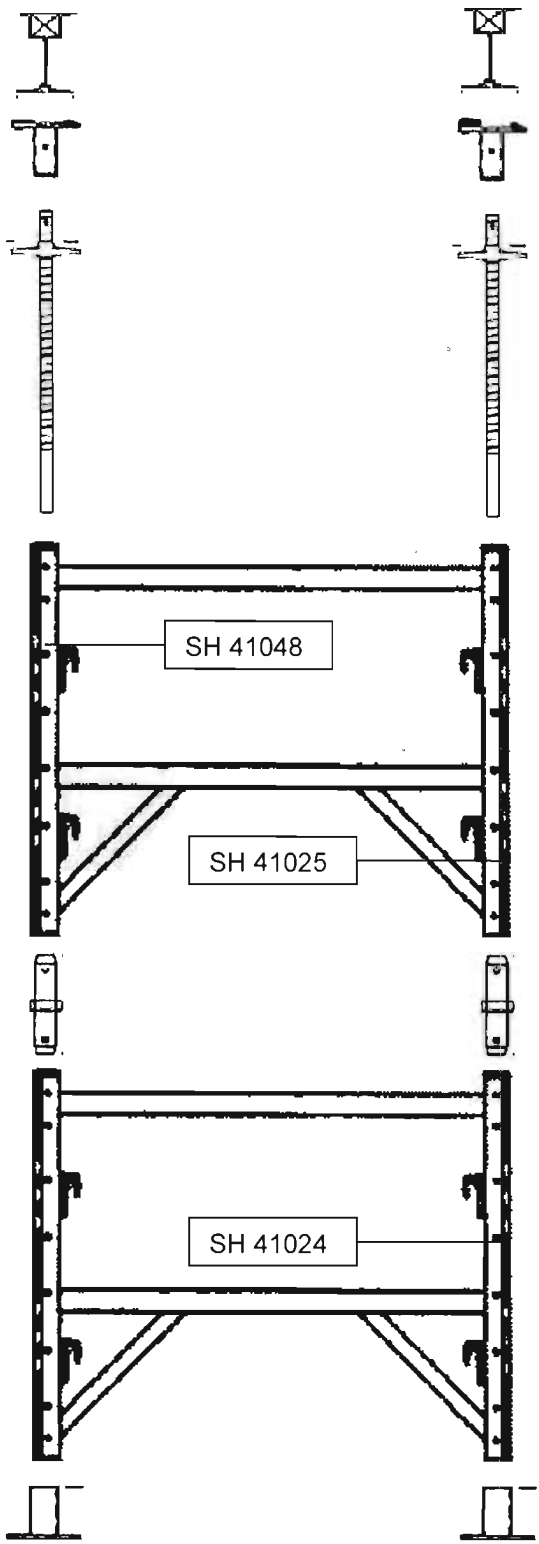

SH 41024  
 Bottom Shore of SH 41025 and SH 41048  
 Zone 41F

Folder: 08-02-06 to 08-02-08; SH 41024



SH 41024 1



SH 41024 2

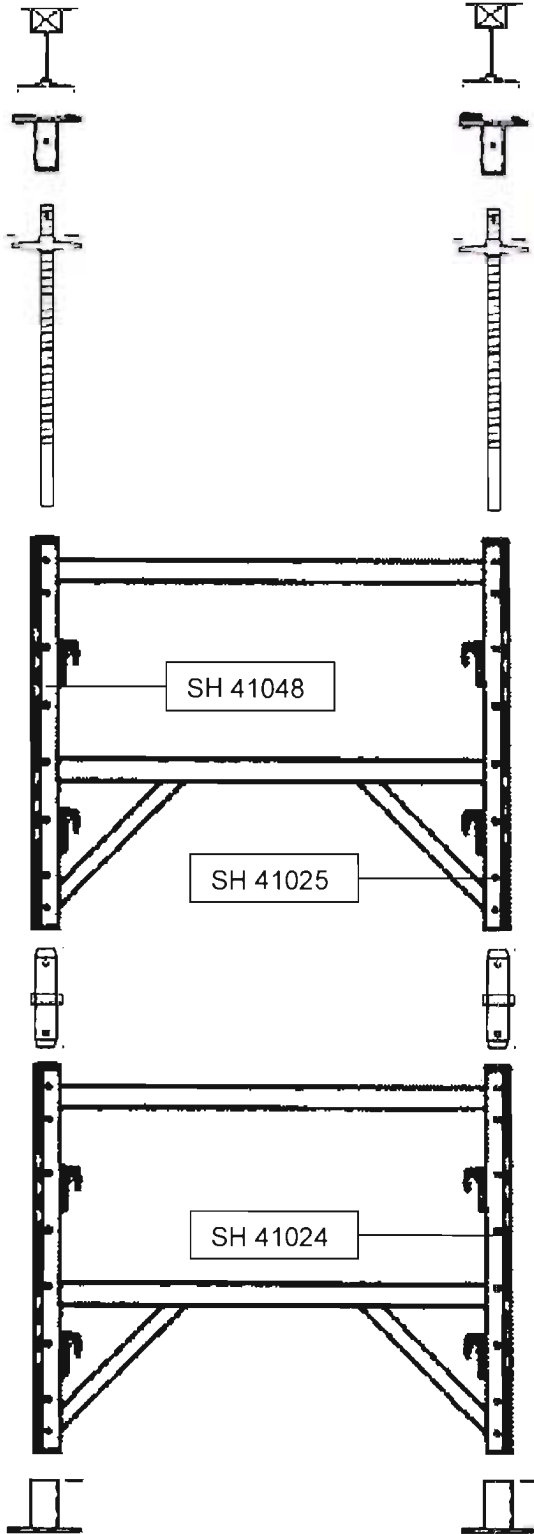

SH 41025  
 Broken Top Shore of SH 41024  
 Connect to top plate SH 41026  
 Zone 41F

Folder: 08-02-06 to 08-02-08; SH 41025

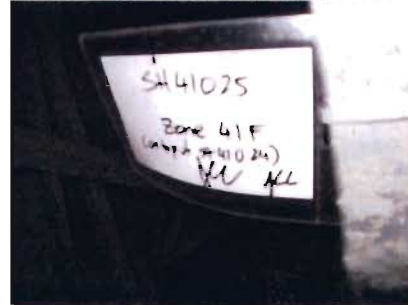

SH 41025 1



SH 41024 2



SH 41025 2

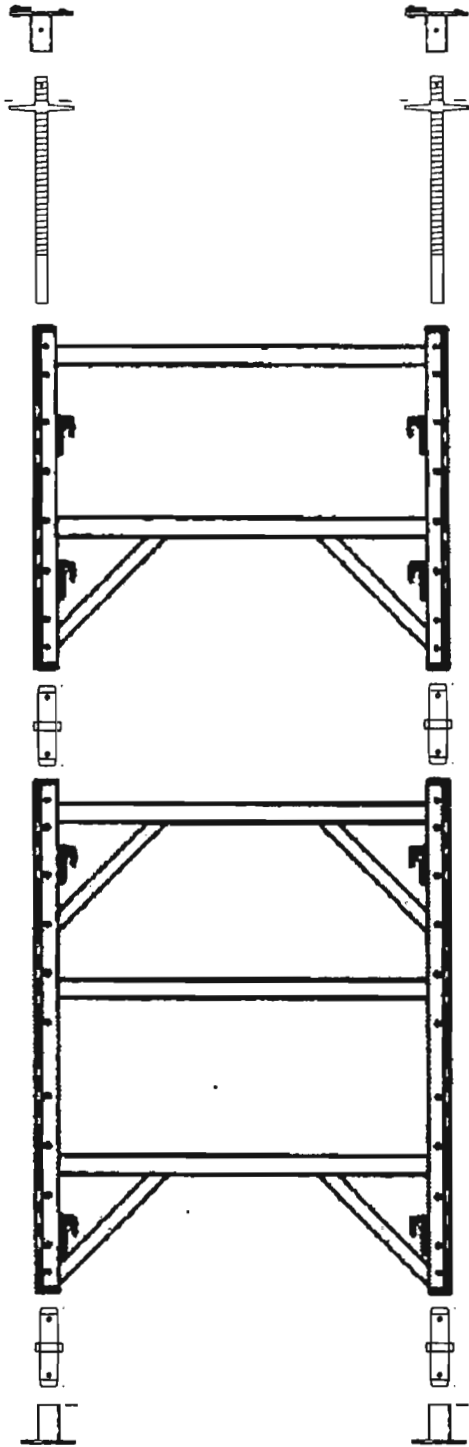

SH 41026  
Top plate of SH 41025  
Zone 41F

Folder: 08-02-06 to 08-02-08; SH 41026

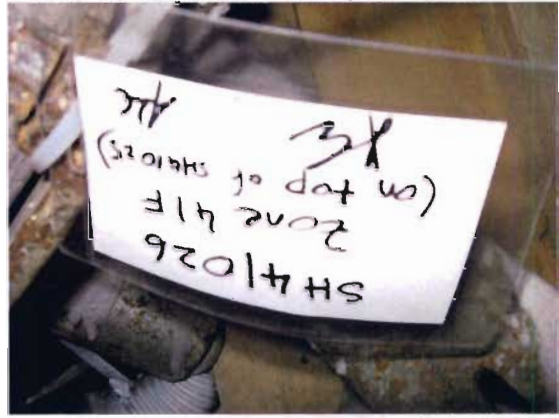

SH 41026 1



SH 41025 2



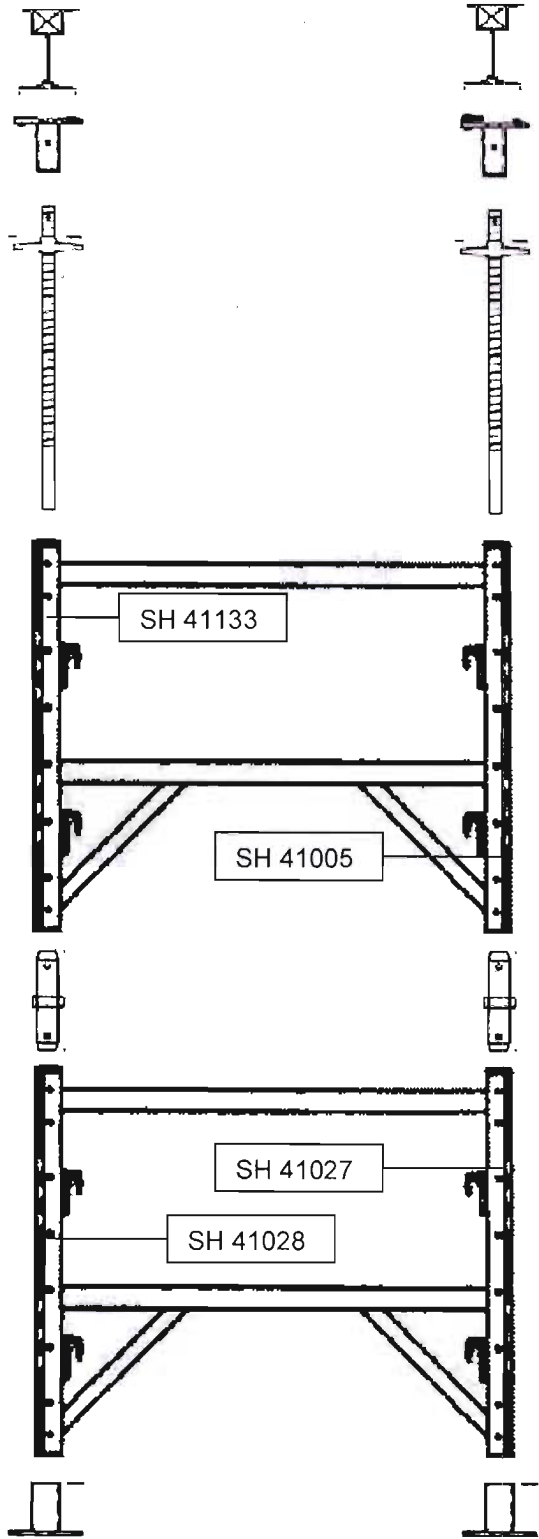

SH 41027  
 Broken  
 Bottom Frame of SH 41005  
 Zone 41G

Folder: 08-02-06 to 08-02-08; SH 41027



SH 41027 1



SH 41027 2

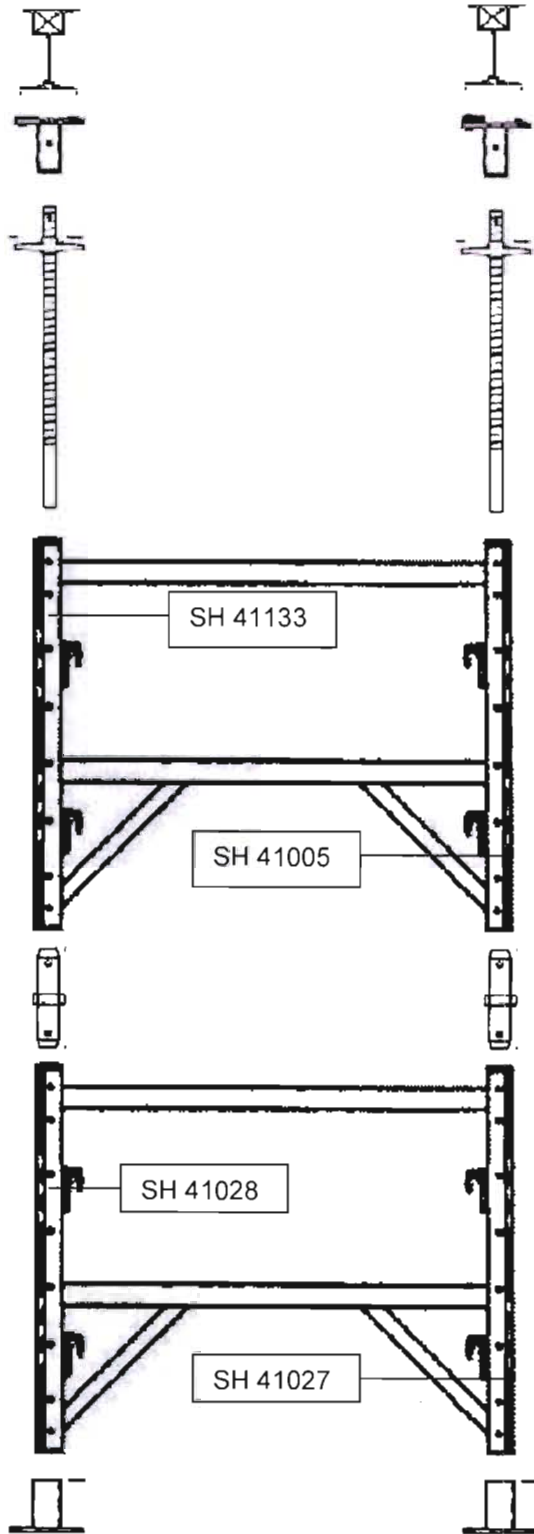

SH 41028  
 Broken  
 Bottom Frame 3'6"  
 Bottom Shore of SH 41005  
 Connected to brace SH 41030  
 Zone 41G

Folder: 08-02-06 to 08-02-08; SH 41028

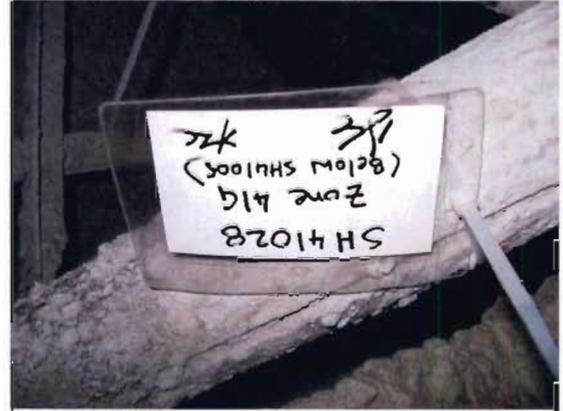

SH 41028 1



SH 41028 2



SH 41028\_3

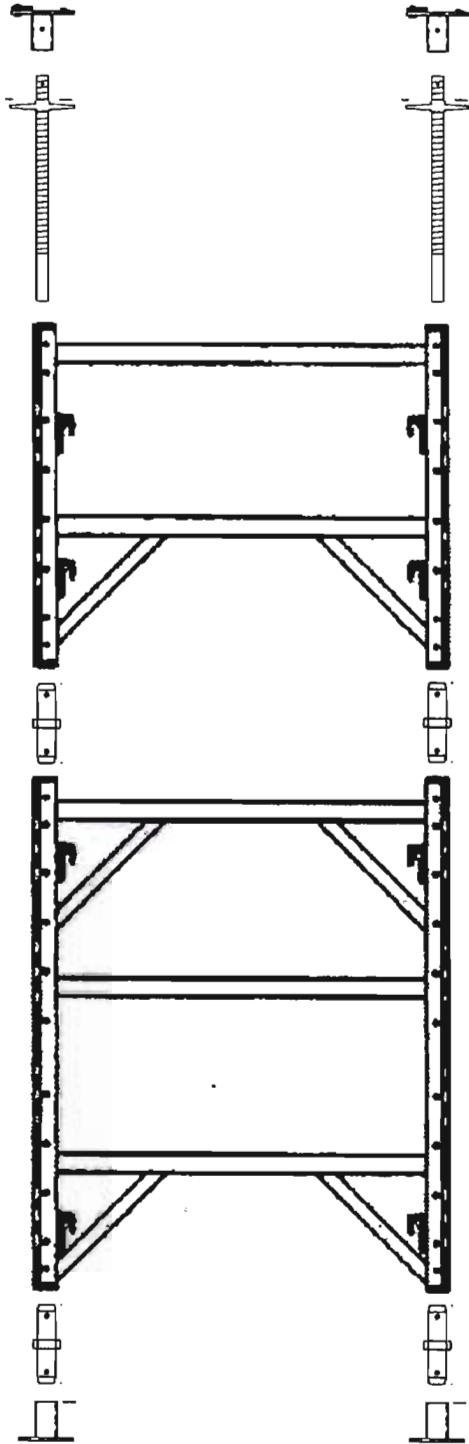

SH 41029  
Top brace  
Attached to SH 410005  
Zone 41F

Folder: 08-02-06 to 08-02-08; SH 41029

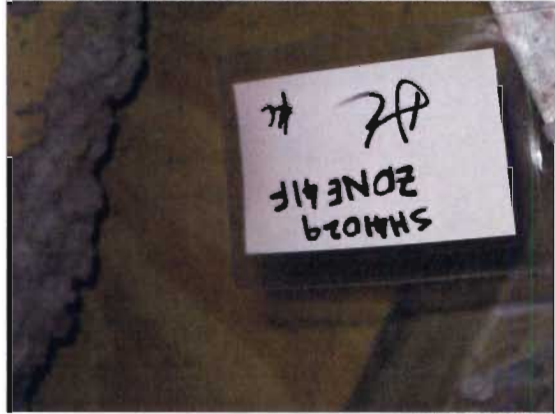

SH 41029 1



SH 41029 2

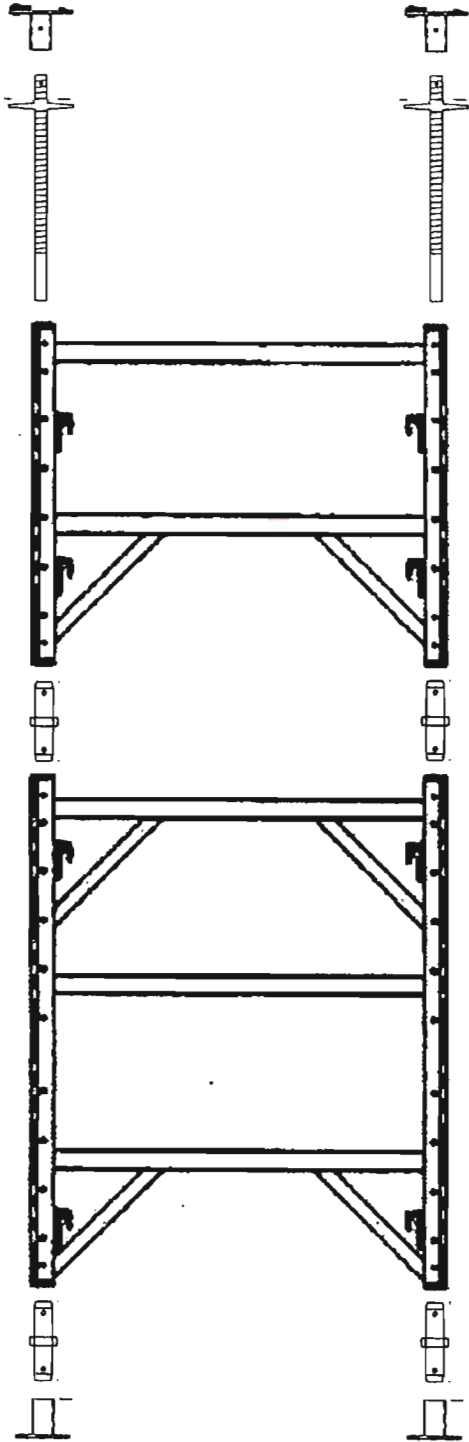

SH 41030  
Bottom Brace  
Attached to SH 41028  
Zone 41F

Folder: 08-02-06 to 08-02-08; SH 41030



SH 41030 1



SH 41030 3

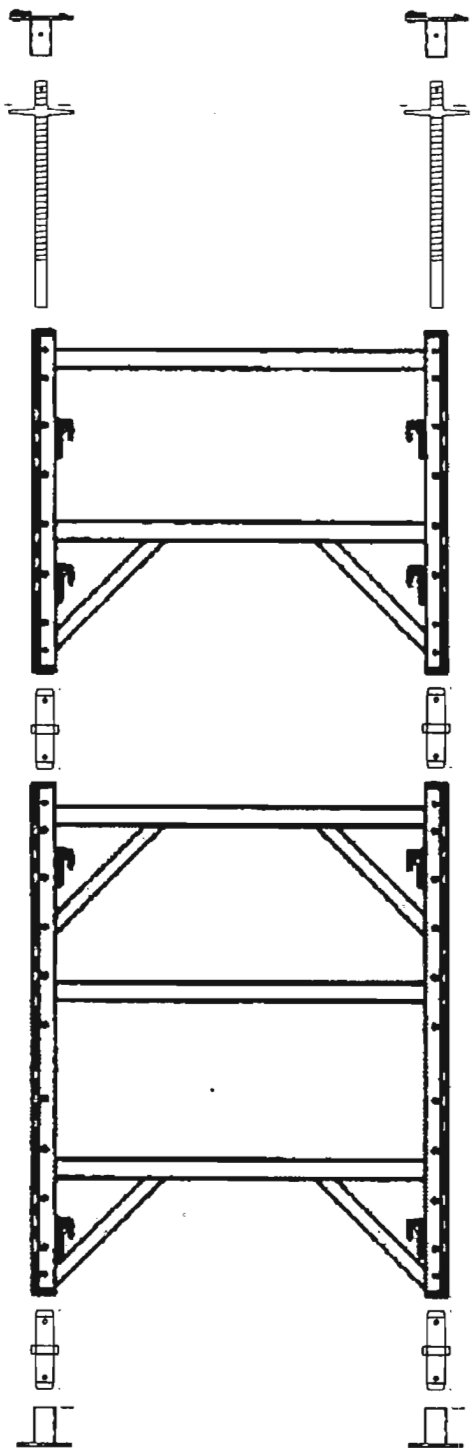

SH 41031  
Top plate of SH 41005 and AB 41004  
Zone 41F

Folder: 08-02-06 to 08-02-08; SH 41031

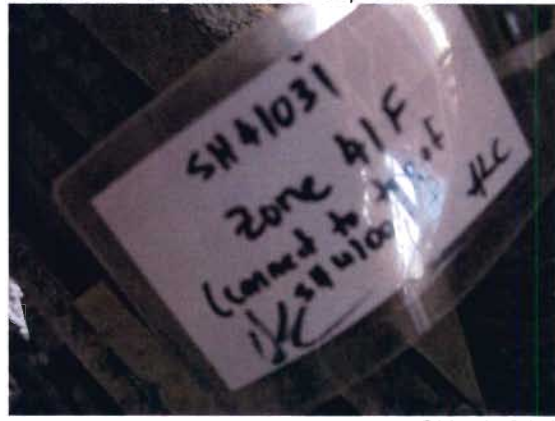

SH 41031 1



SH 41031 2

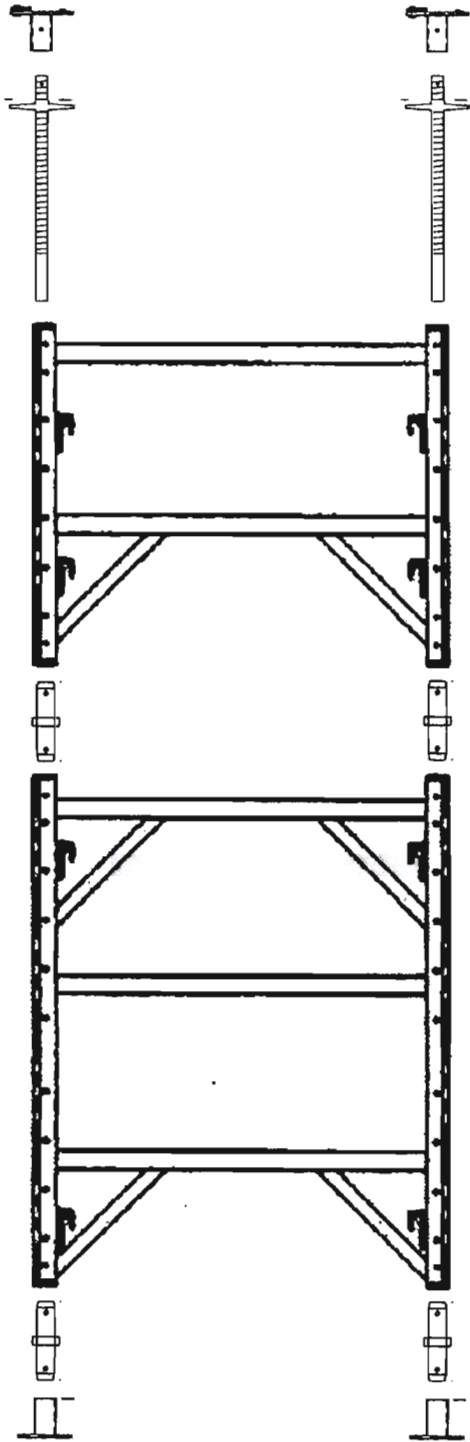

SH 41032  
Brace  
Zone 41J

Folder: 08-02-06 to 08-02-08; SH 41032

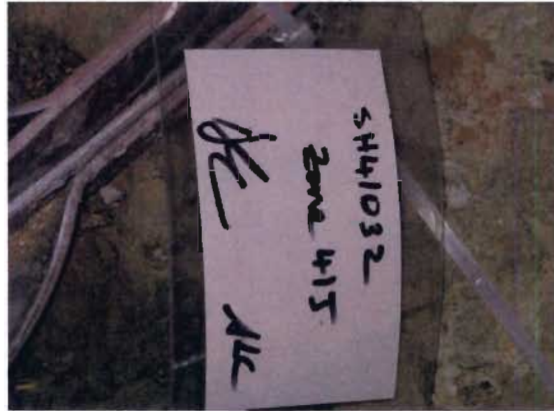

SH 41032 1



SH 41032 2

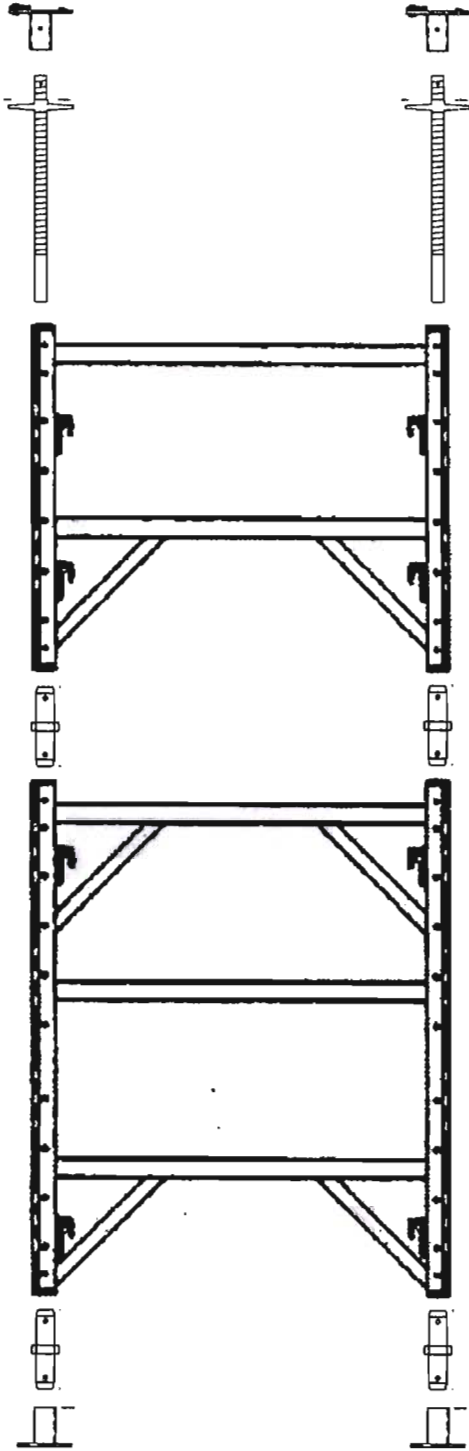

SH 41033  
End plate  
Zone 41J

Folder: 08-02-06 to 08-02-08; SH 41033

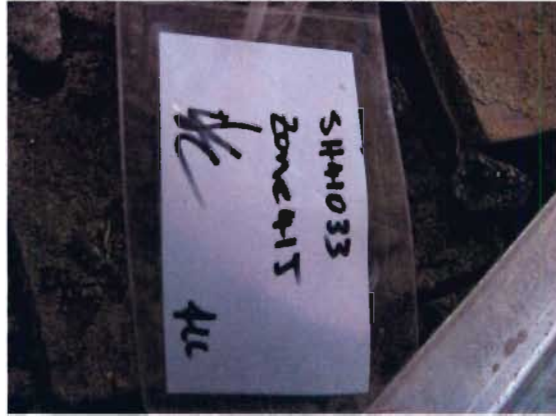

SH 41033 1



SH 41033 2

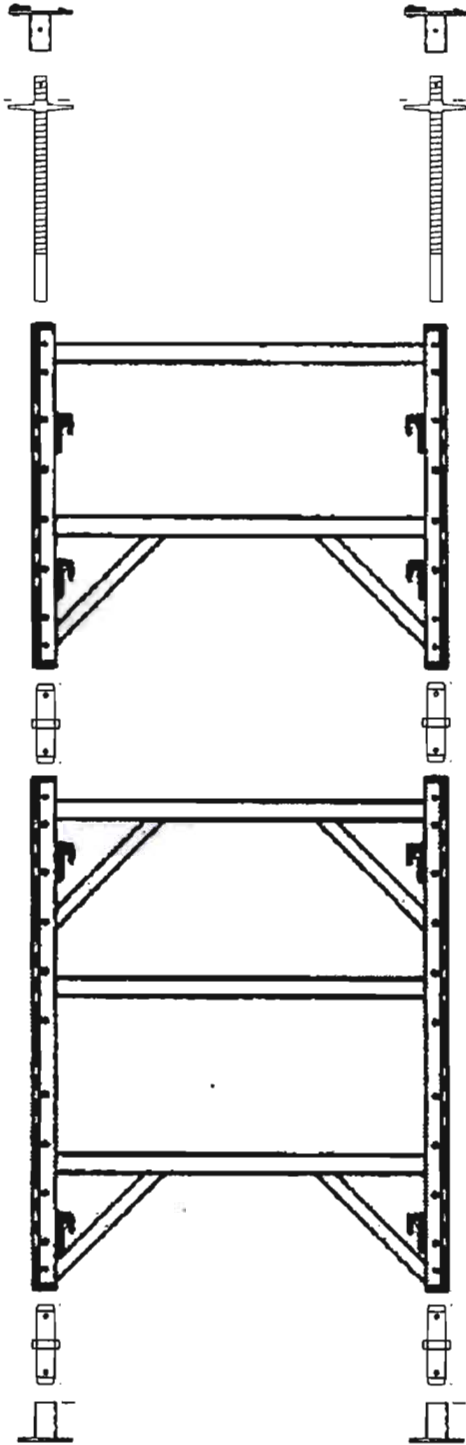

SH 41034  
Coupler  
Zone 41J

Folder: 08-02-06 to 08-02-08; SH 41034

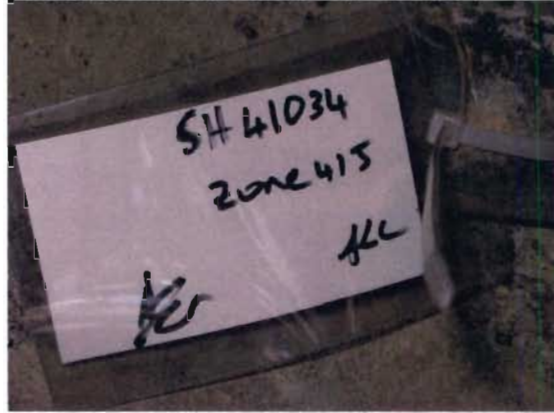

SH 41034 1



SH 41034 2



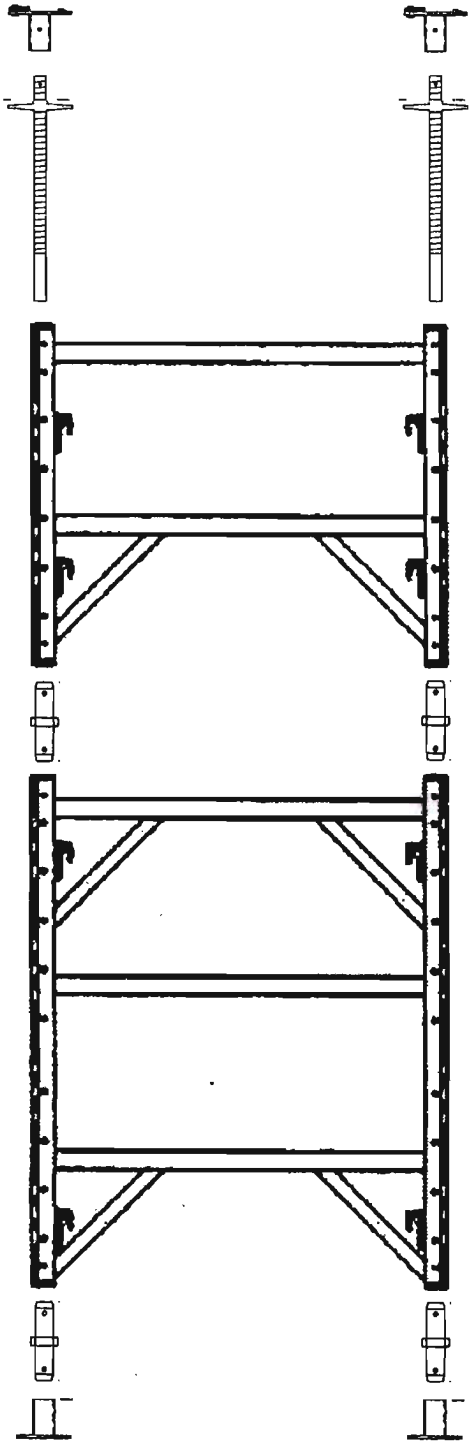

SH 41035  
Coupler

Folder: 08-02-06 to 08-02-08; SH 41035



SH 41035 1



SH 41035 2

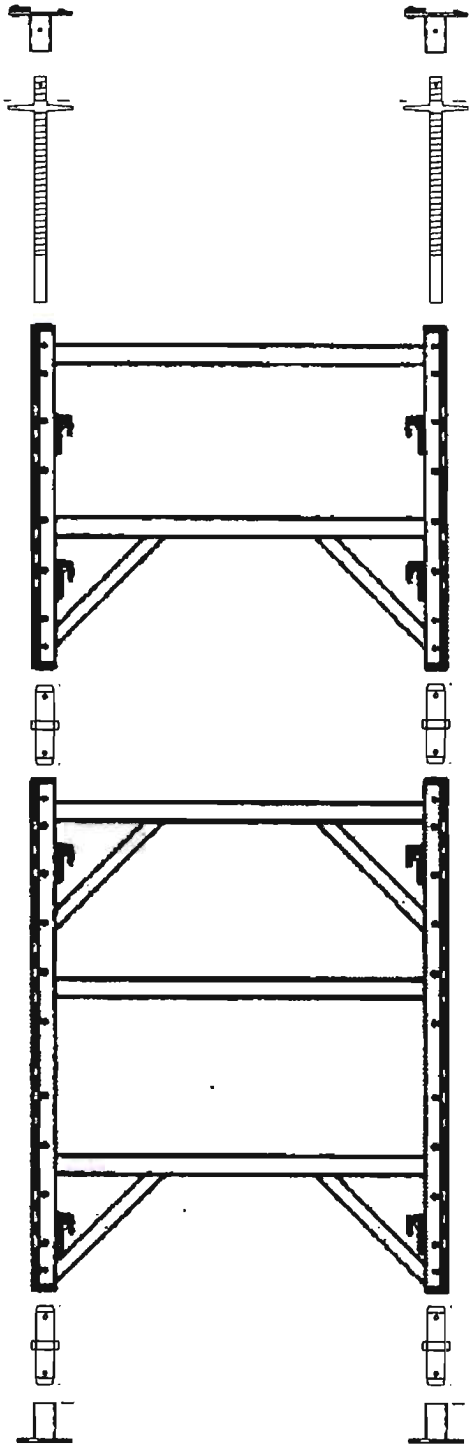

SH 41036  
Brace  
Zone 41B

Folder: 08-02-06 to 08-02-08; SH 41036

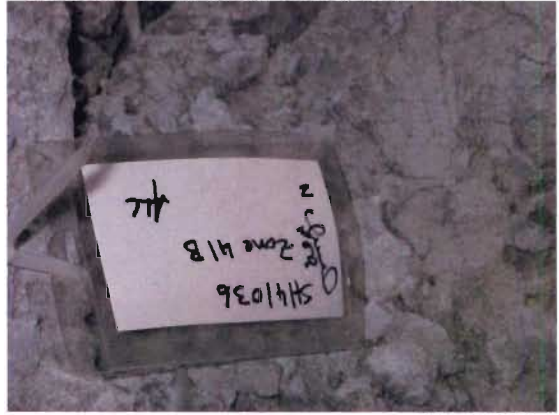

SH 41036 1



SH 41036 2

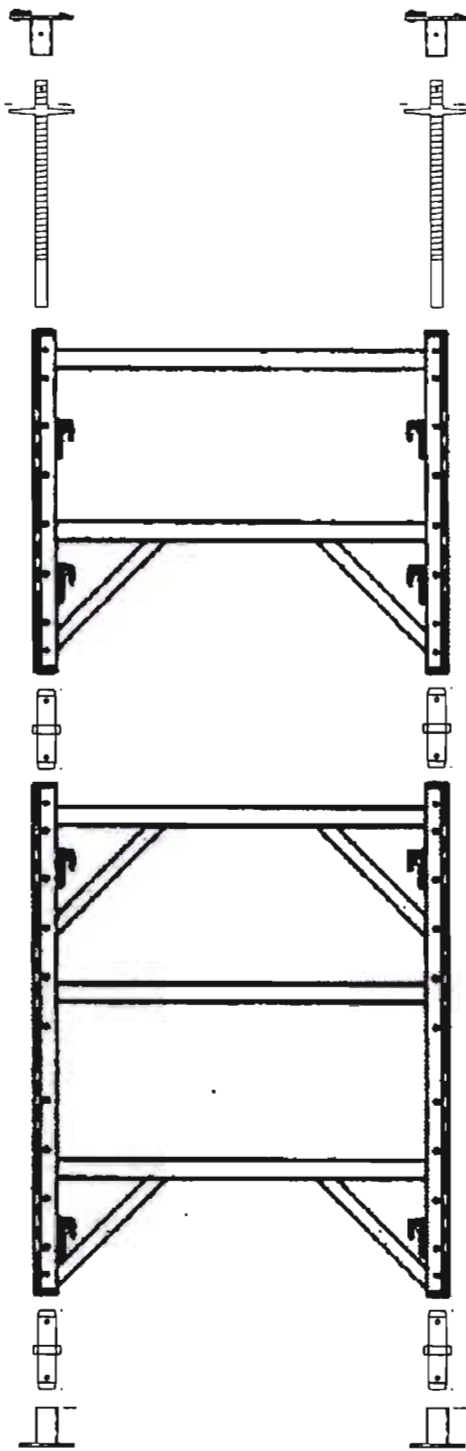

SH 41037  
Brace  
Zone 41B

Folder: 08-02-06 to 08-02-08; SH 41037

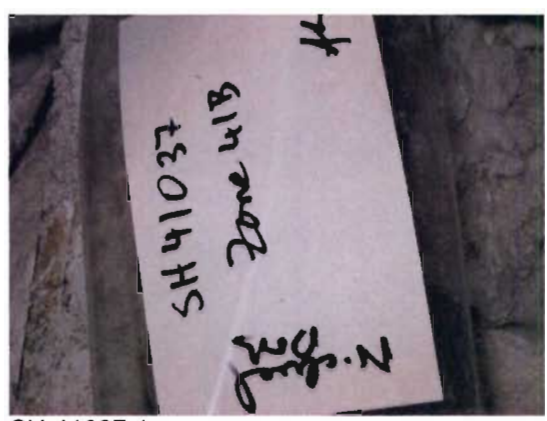

SH 41037 1



SH 41037 2

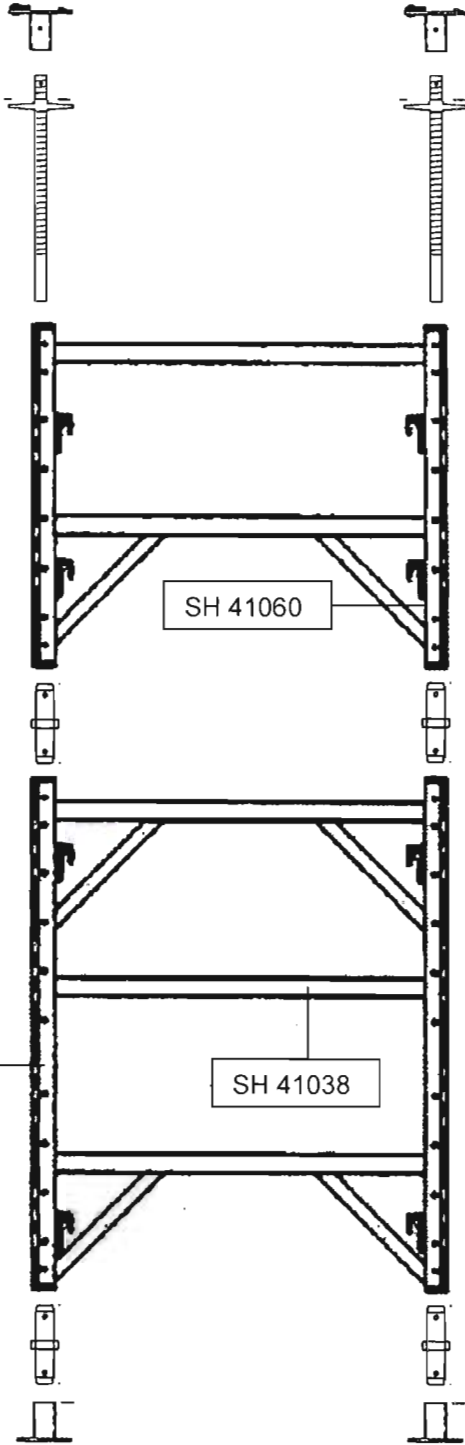

SH 41038  
 Bottom Piece of Shoring frame  
 Attached to SH 41060  
 Zone 41B

Folder: 08-02-06 to 08-02-08; SH 41038



SH 41038 1



SH 41038 2

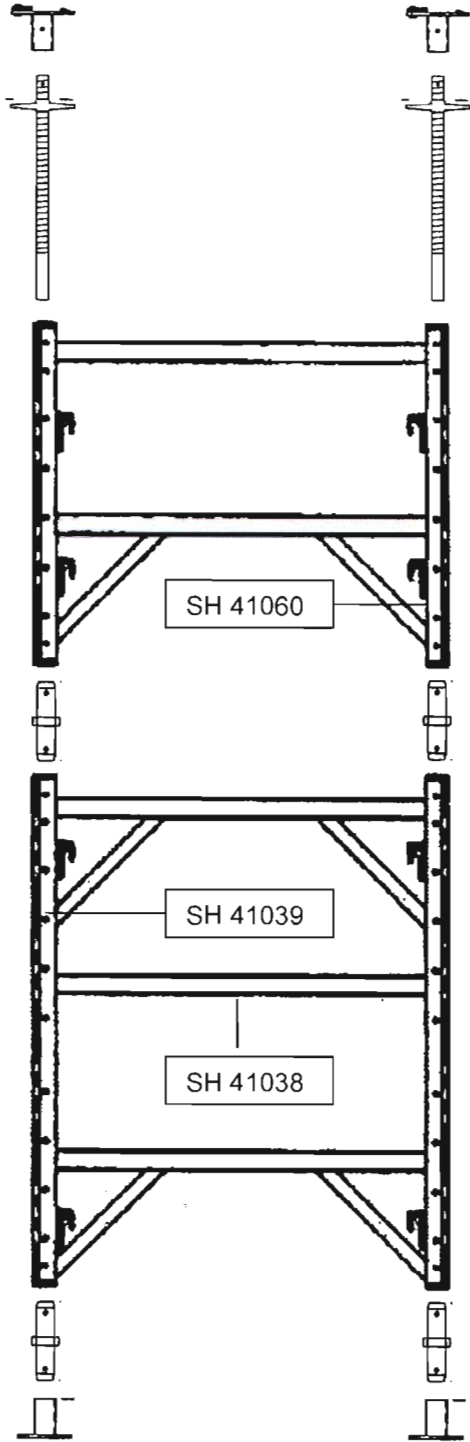

SH 41039  
 Bottom Frame of SH 41060  
 Part of SH 41038  
 Zone 41B

Folder: 08-02-06 to 08-02-08; SH 41039



SH 41039 1



SH 41039 2

SH 41040  
Cross Brace SH 41024  
No photo  
Zone 41B

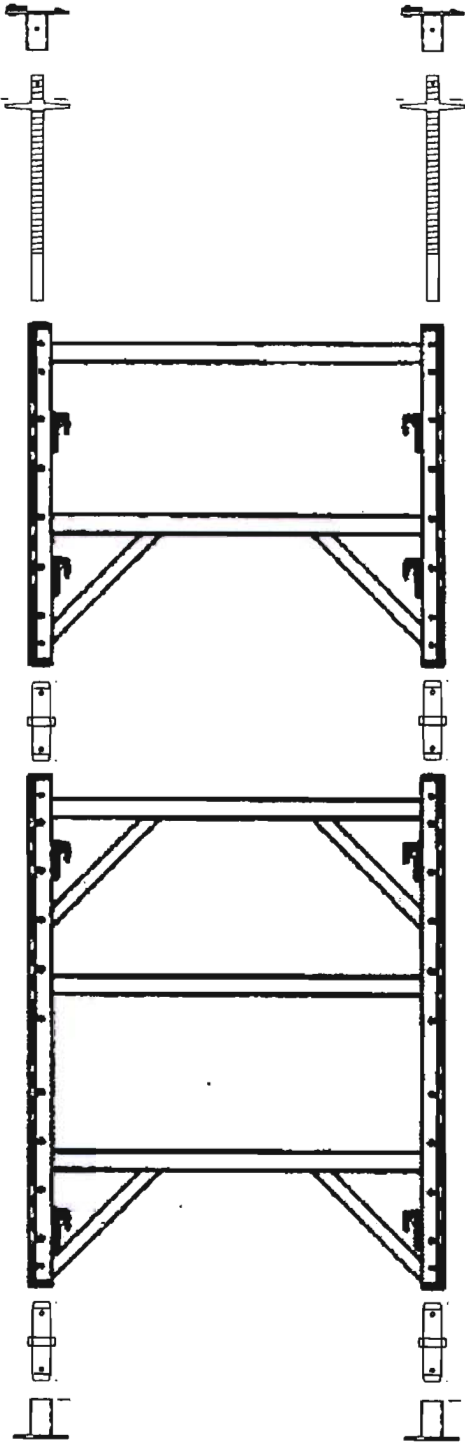

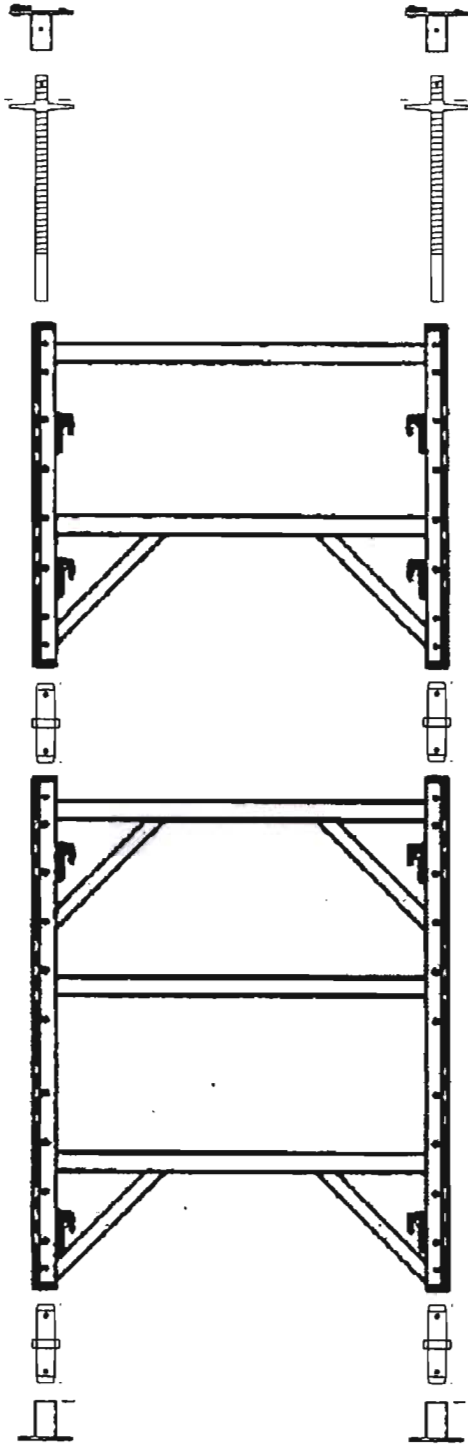

SH 41041  
Screw Jack  
Zone 41B

Folder: 08-02-06 to 08-02-08; SH 41041

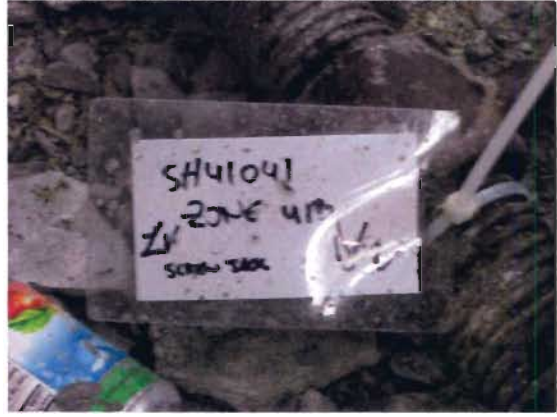

SH41041\_1



SH41041\_2

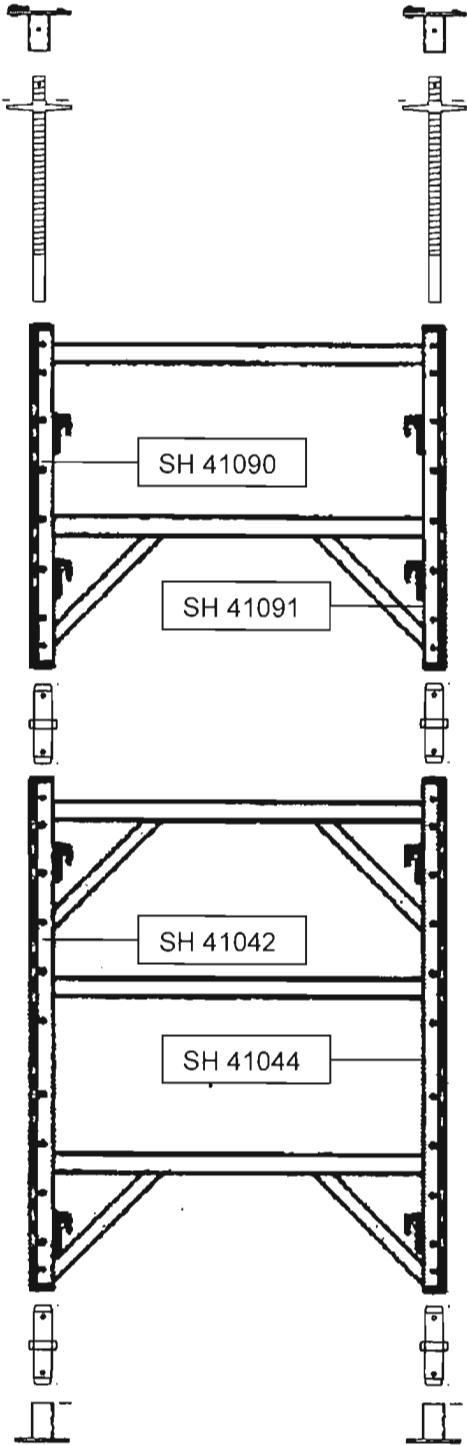

SH 41042  
 Bottom frame of SH 41091 & SH 41090  
 Attached to SH 41043  
 Zone 41F

Folder: 08-02-06 to 08-02-08; SH 41042

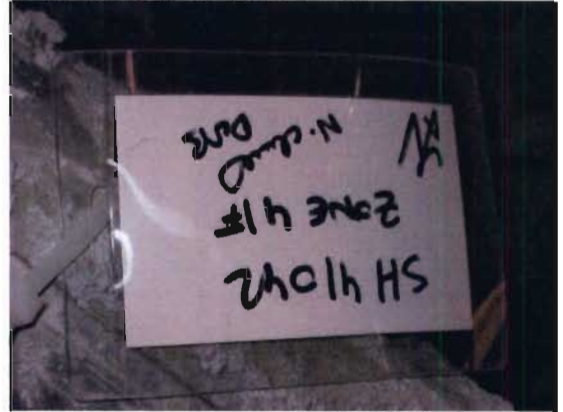

SH41042\_1



SH41042\_2



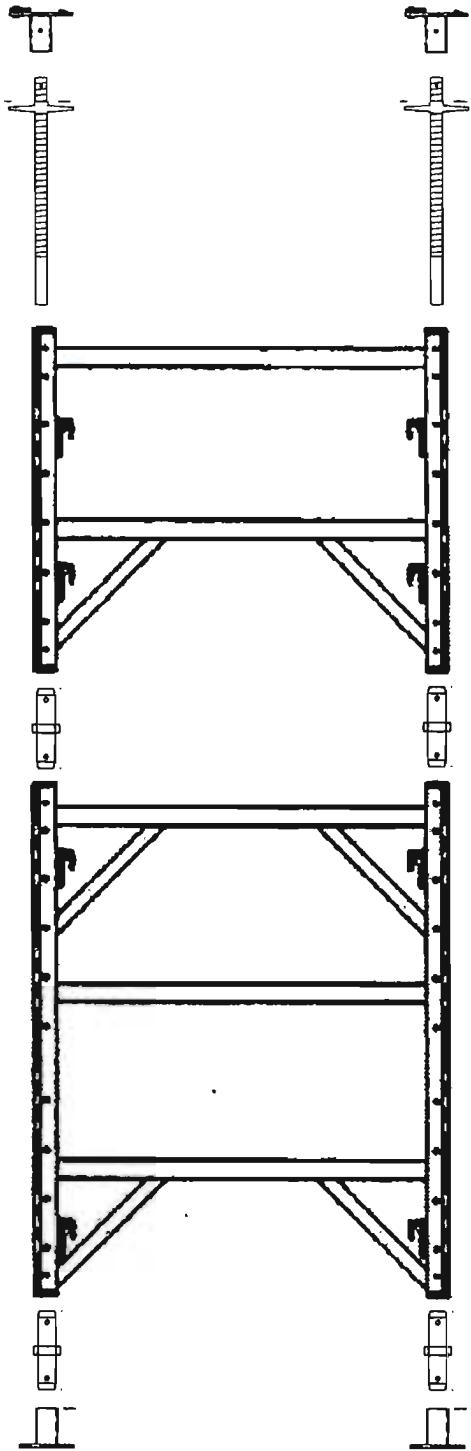

SH 41043  
Brace  
Attached to SH 41042  
Zone 41F

Folder: 08-02-06 to 08-02-08; SH 41043



SH41043\_1



SH41043\_2

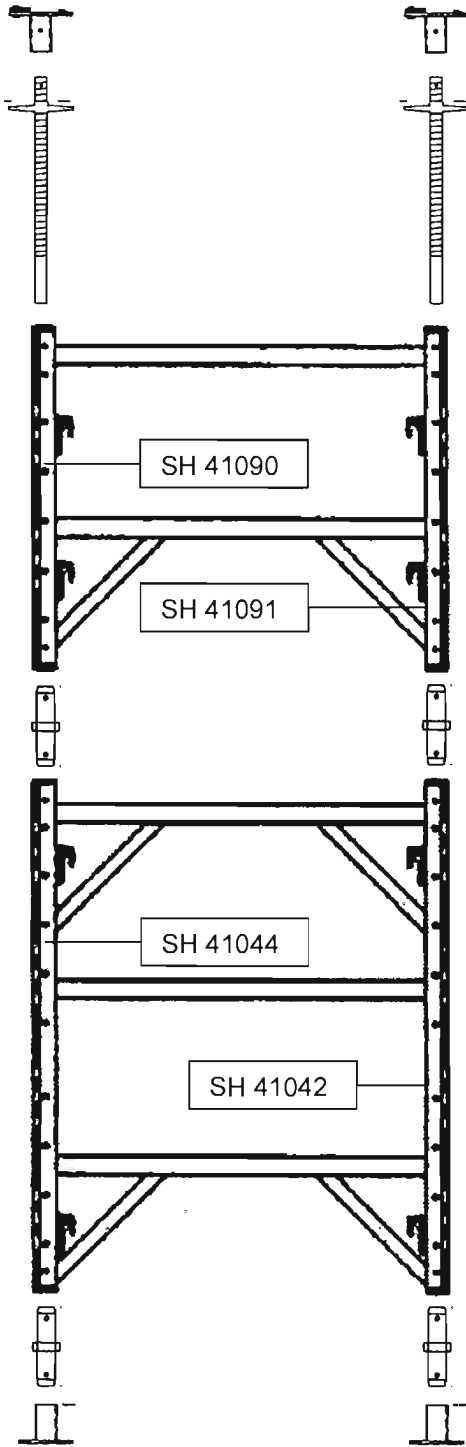

SH 41044  
 Broken With SH 41042  
 Bottom Shore of SH 41090 & SH 41091  
 Attached to SH 41042  
 Zone 41F

Folder: 08-02-06 to 08-02-08; SH 41044

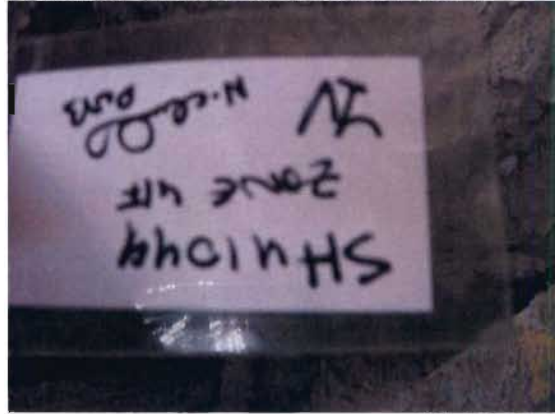

SH41044\_1



SH41044\_2

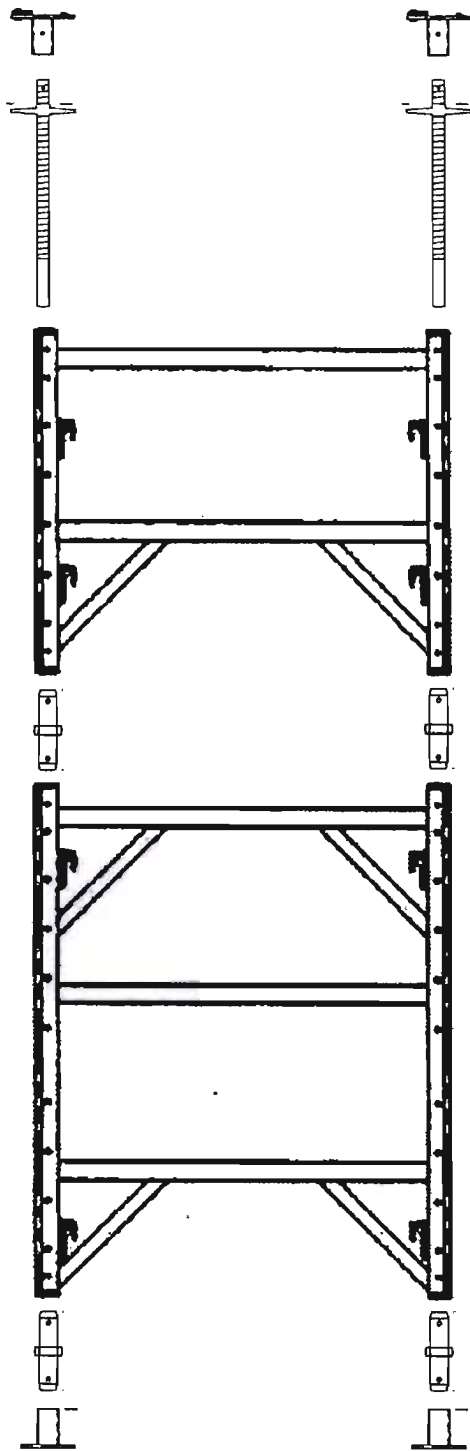

SH 41045  
Bottom Brace of SH 41024  
Zone 41F

Folder: 08-02-06 to 08-02-08; SH 41045

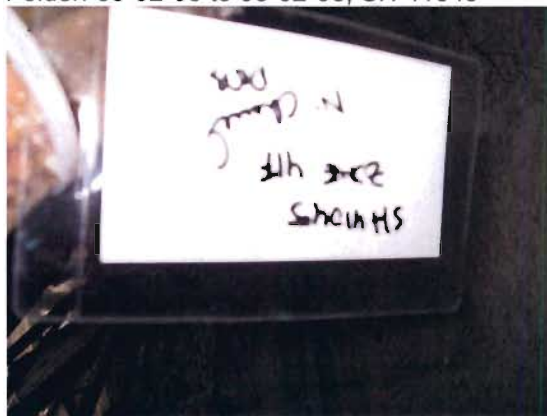

SH41045\_1



SH41045\_2

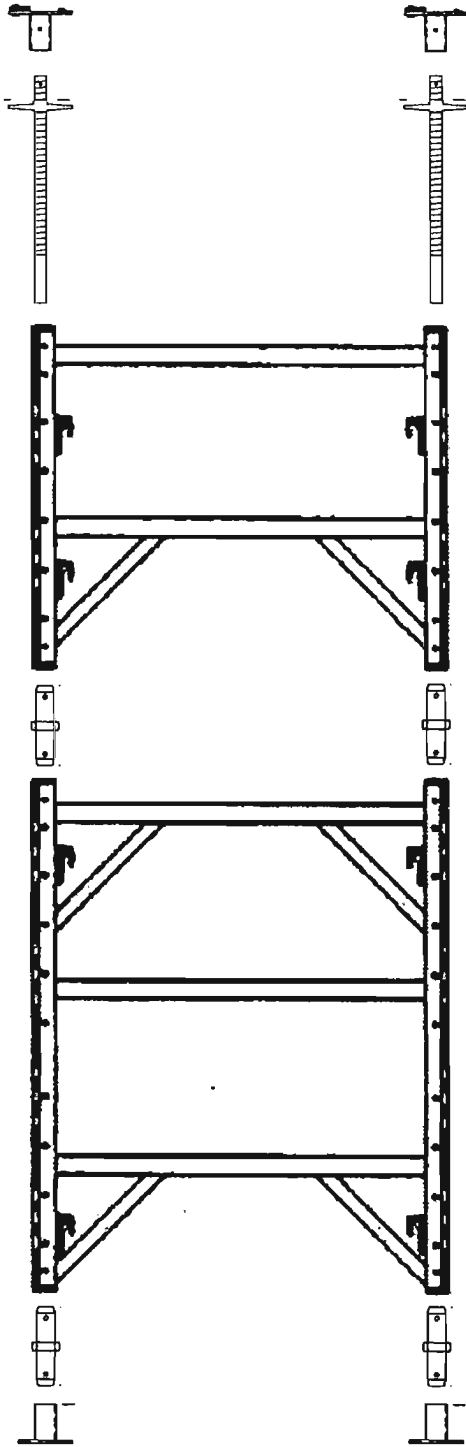

SH 41046  
Brace  
Connected to SH 41047  
Zone 41F

Folder: 08-02-06 to 08-02-08; SH 41046



SH41047\_2

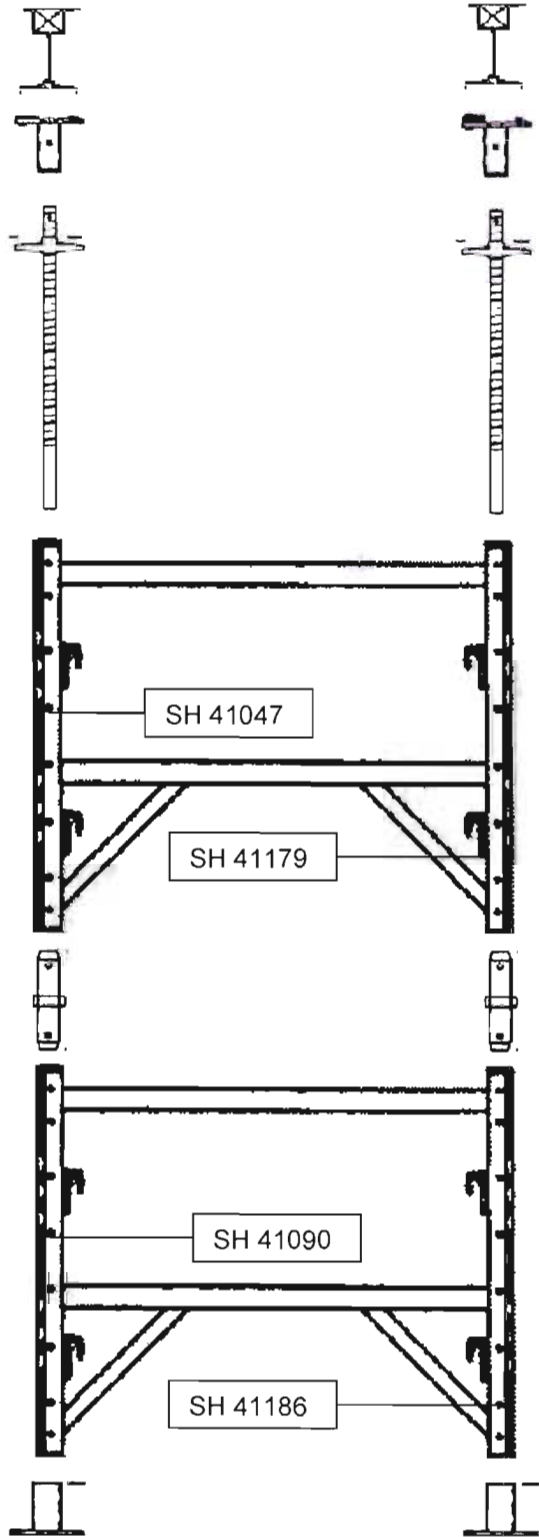

SH 41047  
 Broken With SH 41179  
 Top Shore of SH 41186 & SH 41190  
 Attached to brace SH 41046  
 Zone 41F

Folder: 08-02-06 to 08-02-08; SH 41047



SH41047\_1



SH41047\_2

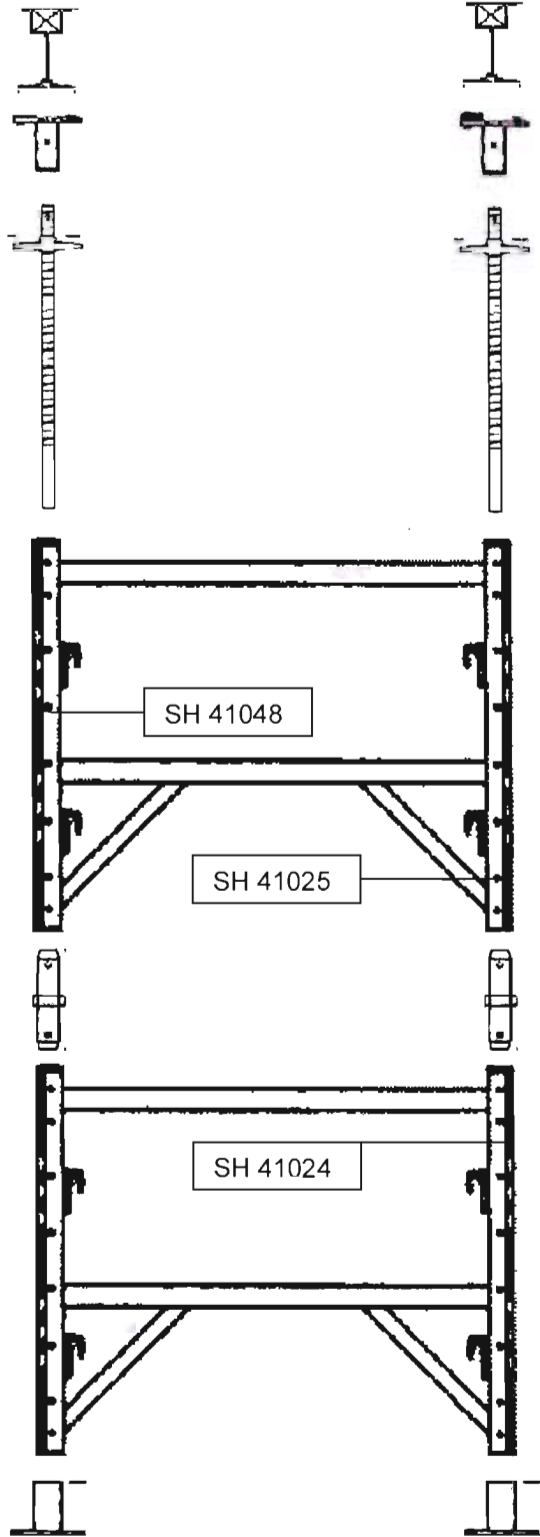

SH 41048  
 Broken  
 Top Shore  
 Attached to SH 41046 on top SH 41024  
 Piece of Frame SH 41049  
 Zone 41F

Folder: 08-02-06 to 08-02-08; SH 41048

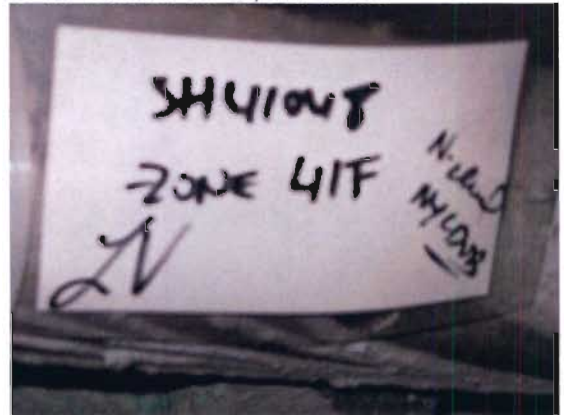

SH41048\_1



SH41048\_2

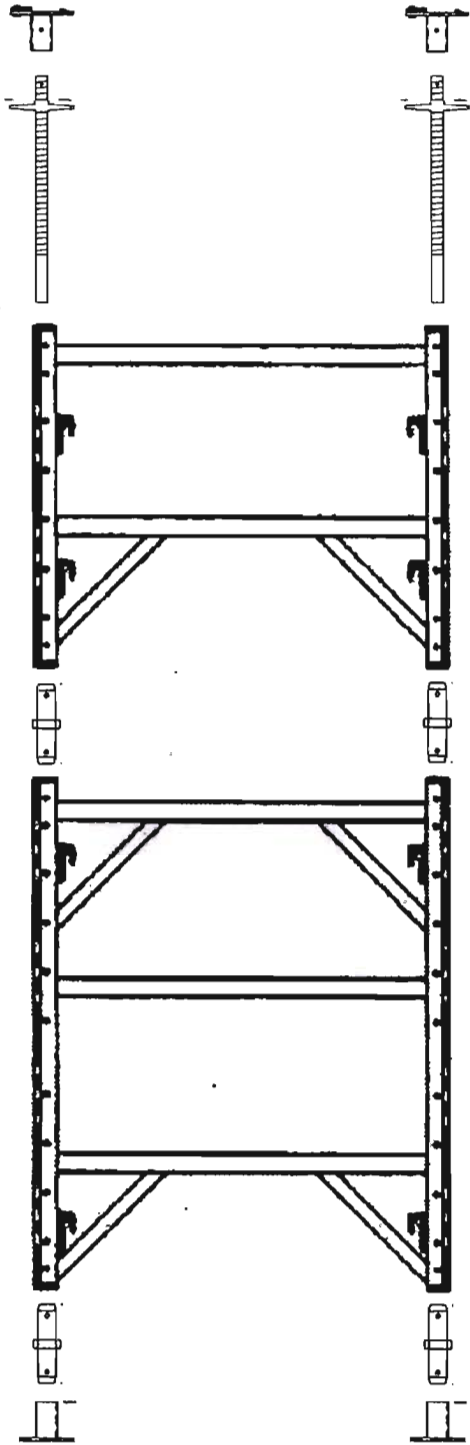

SH 41049  
Broken piece from SH 41048  
Zone 41 F

Folder: 08-02-06 to 08-02-08; SH 41049

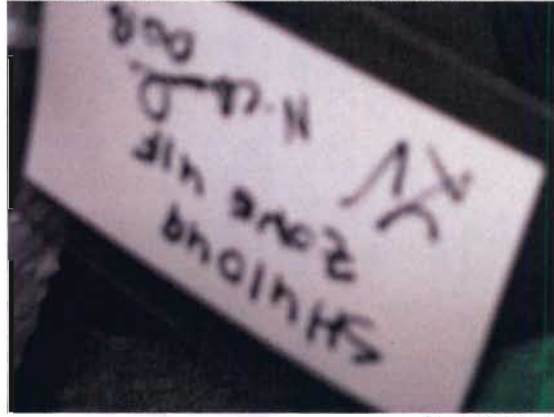

SH41049\_1



SH41049\_2

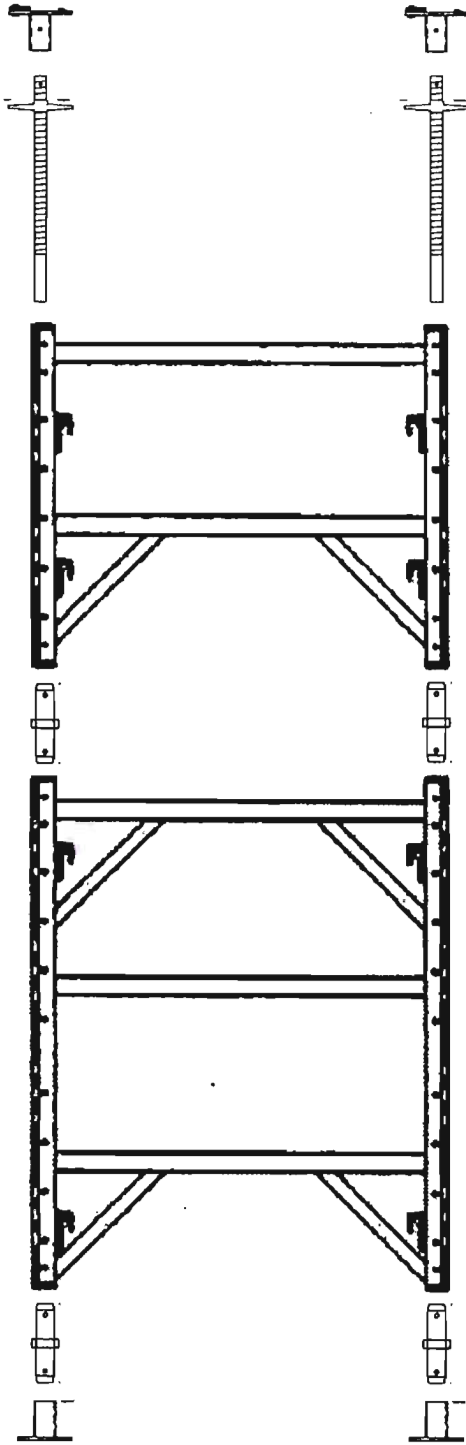

SH 41050  
Brace  
Zone 41F

Folder: 08-02-06 to 08-02-08; SH 41050



SH41050\_1



SH41050\_2



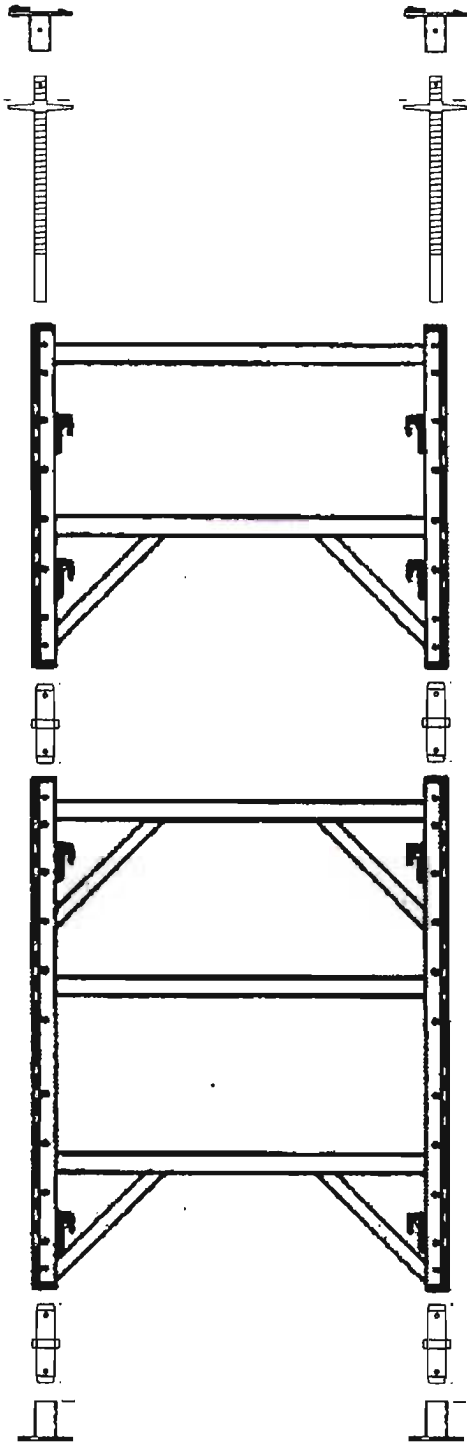

SH 41051  
Broken piece of frame  
Attached to bottom SH 41044  
Zone 41F

Folder: 08-02-06 to 08-02-08; SH 41051

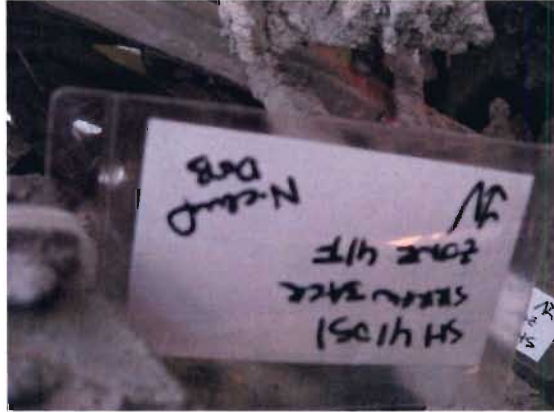

SH41051\_1



SH41051\_2

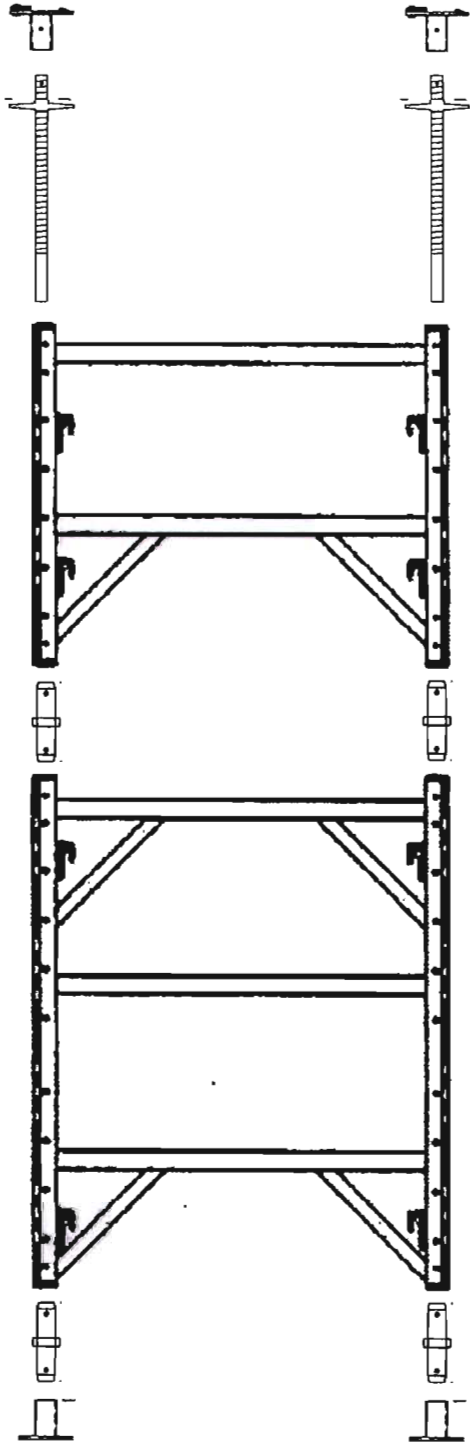

SH 41052  
Brace  
Zone 41F

Folder: 08-02-06 to 08-02-08; SH 41052



SH41052\_1



SH41052\_2

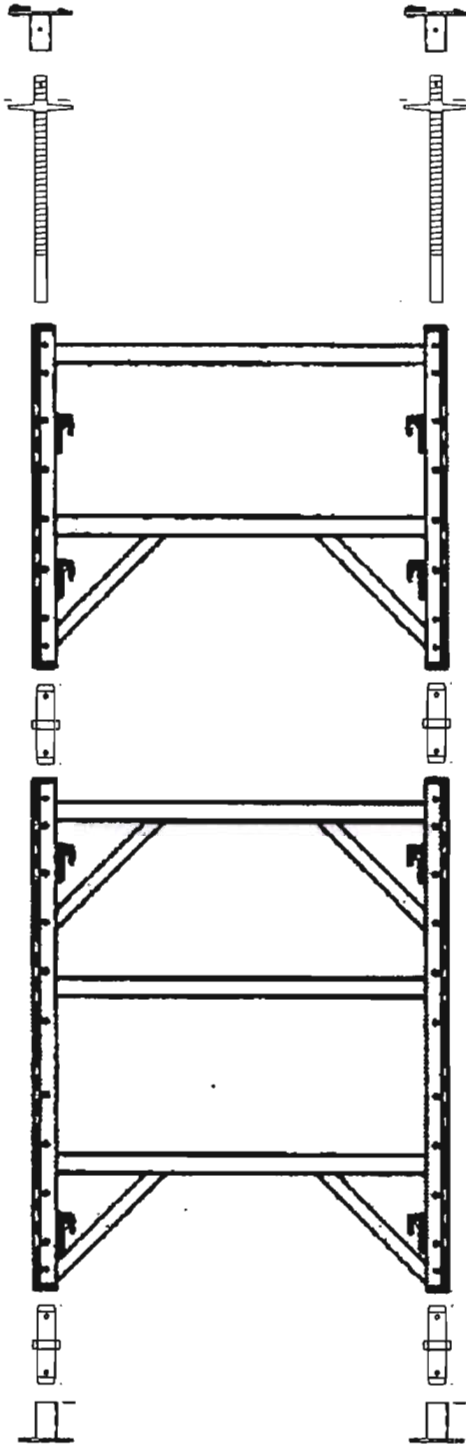

SH 41053  
Screw Jack  
Zone 41F

Folder: 08-02-06 to 08-02-08; SH 41053



SH41053\_1



SH41053\_2

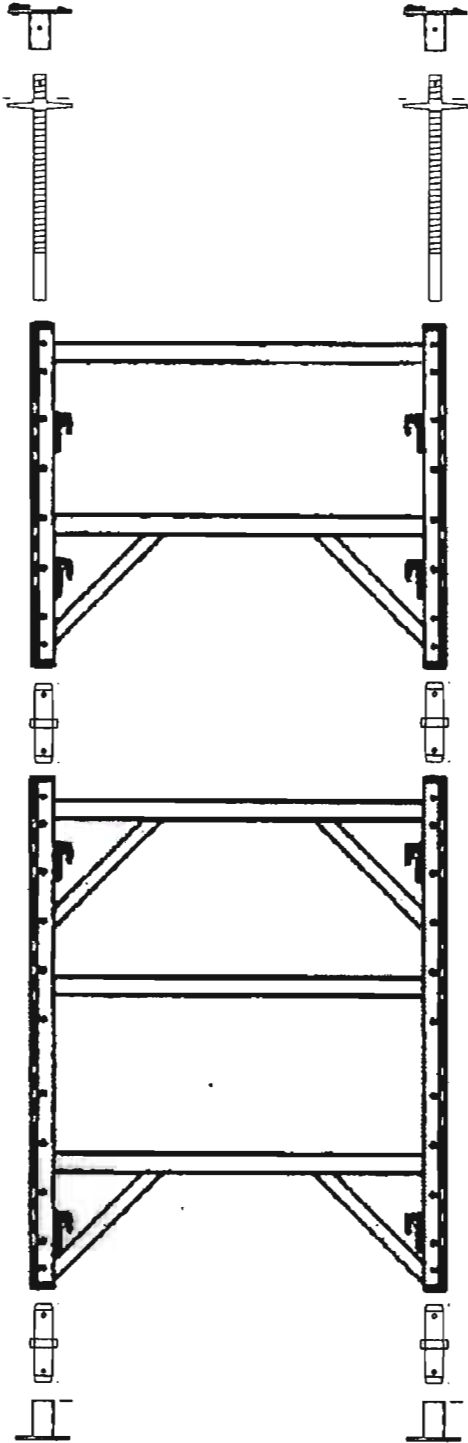

SH 41054  
Brace  
Zone 41F

Folder: 08-02-06 to 08-02-08; SH 41054

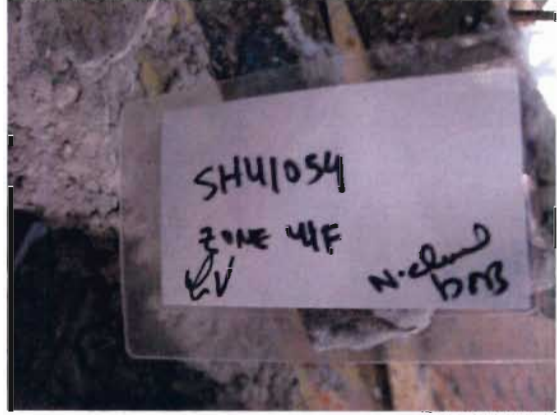

SH41054\_1



SH41054\_2

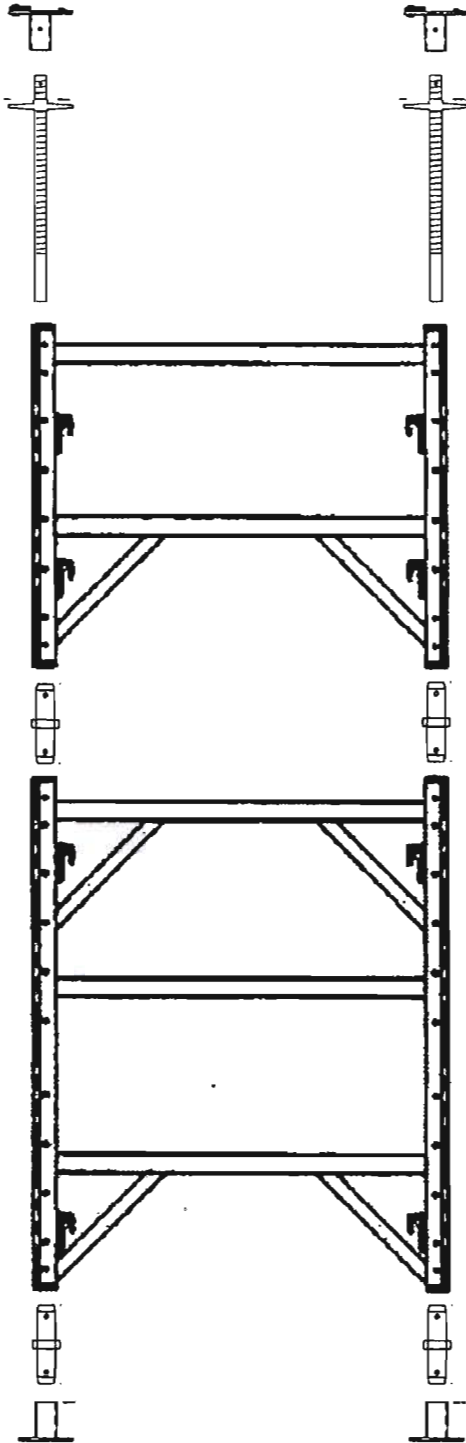

SH 41055  
Bottom Plate  
Zone 41F

Folder: 08-02-06 to 08-02-08; SH 41055

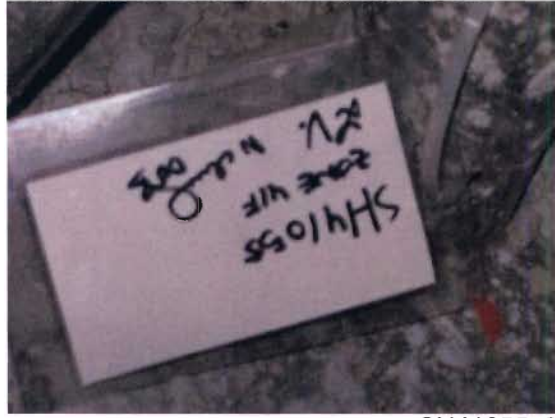

SH41055\_2



SH41055\_1

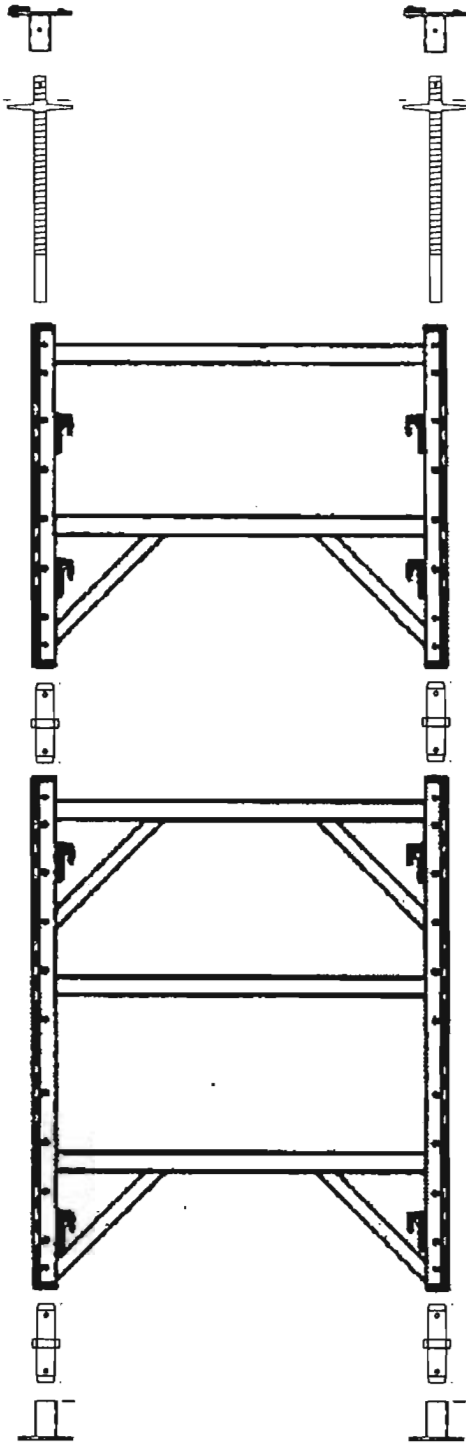

SH 41056  
Top plate and Screw Jack  
Zone 41B

Folder: 08-02-06 to 08-02-08; SH 41056

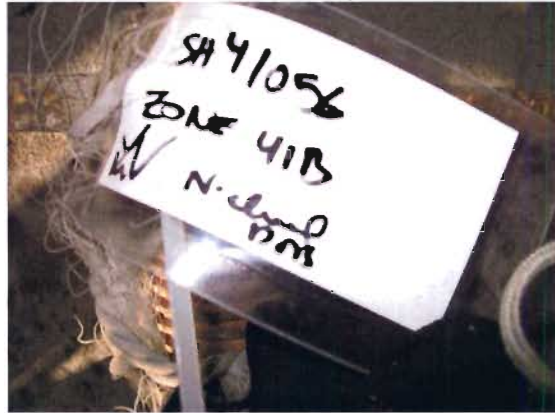

SH41056\_1



SH41056\_2

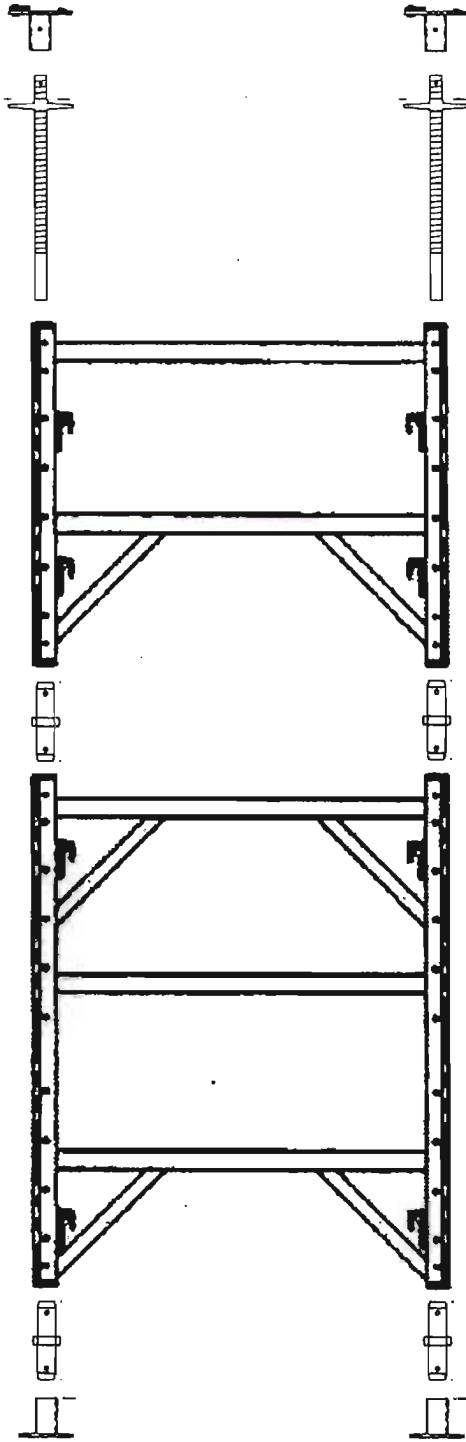

SH 41057  
Top plate and Screw Jack  
Zone 41B

Folder: 08-02-06 to 08-02-08; SH 41057



SH41058\_1



SH41058\_2

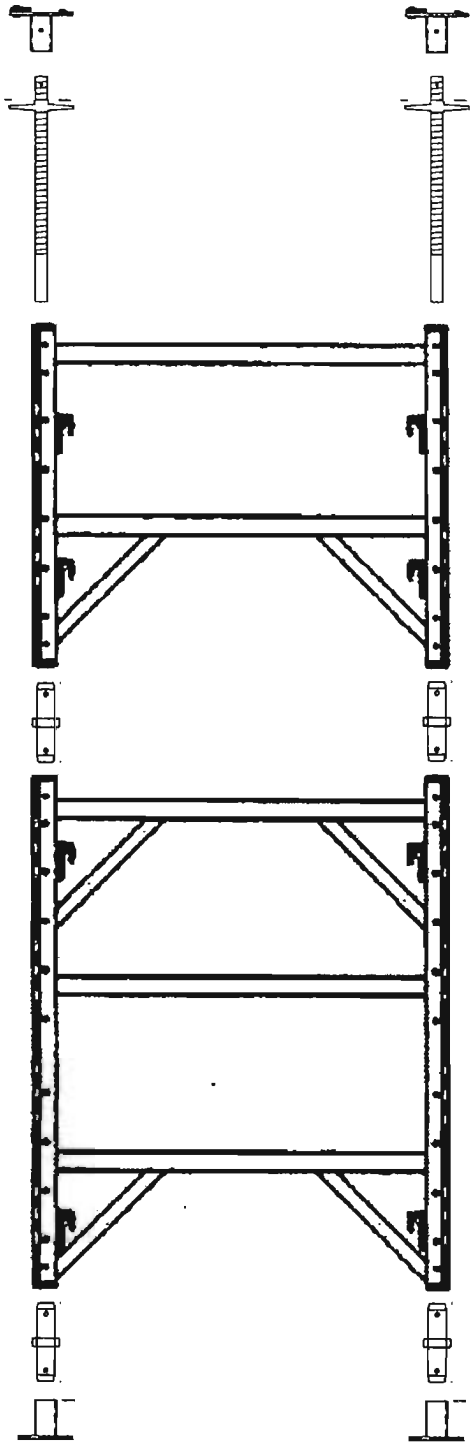

SH 41058  
Top plate and Screw Jack  
Zone 41B

Folder: 08-02-06 to 08-02-08; SH 41058

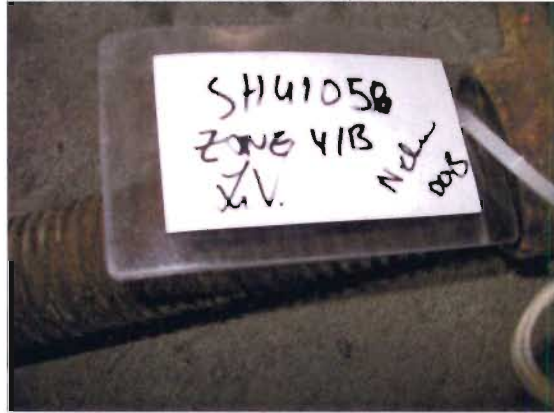

SH41058\_1



SH41058\_2



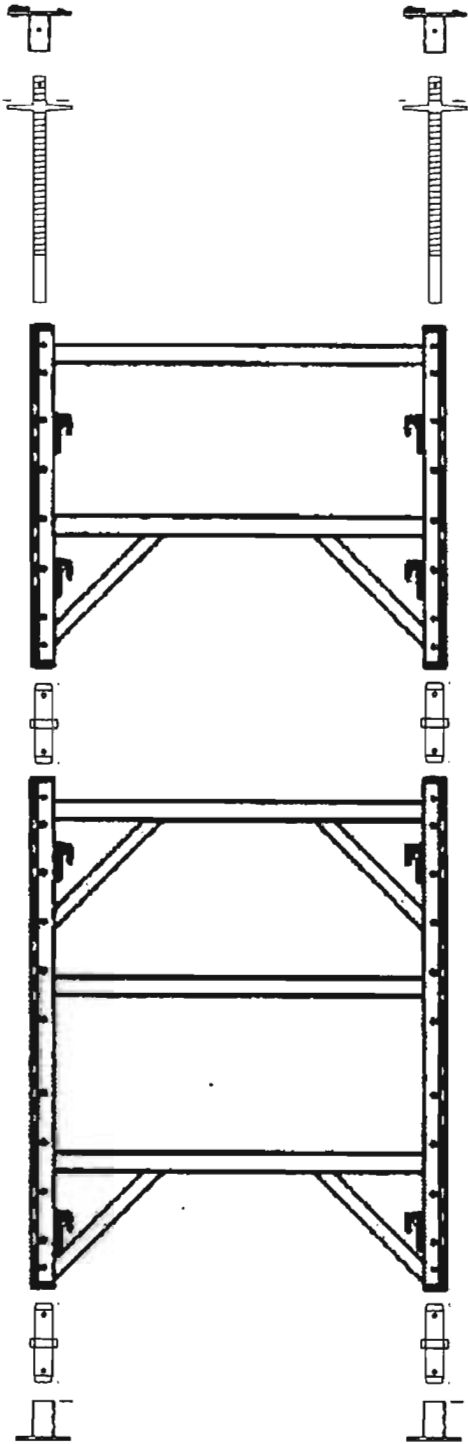

SH 41059  
Top Plate and Screw Jack  
Zone 41B

Folder: 08-02-06 to 08-02-08; SH 41059

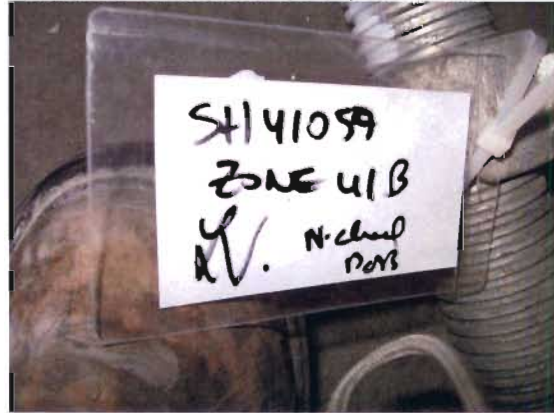

SH41059\_1



SH41059\_2

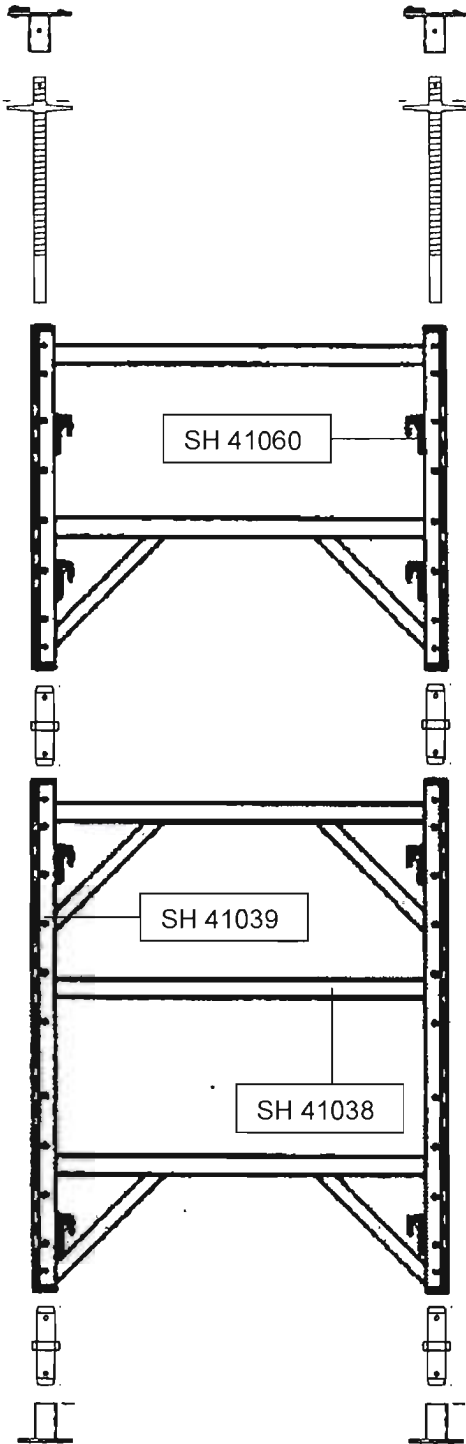

SH 41060  
 Top frame of SH 41038  
 Zone 41B

Folder: 08-02-06 to 08-02-08; SH 41060



SH41060\_1



SH41060\_2



SH41060\_3

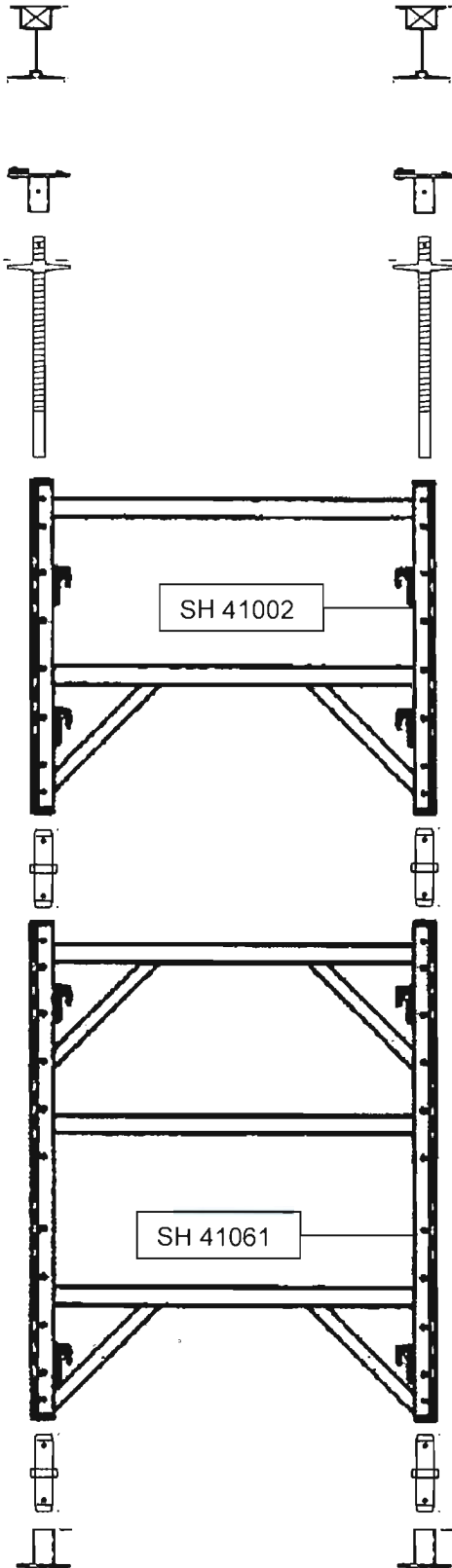

SH 41061  
 Bottom of SH 41002  
 Zone 41K

Folder: 08-02-11; 08-02-11; SH 41061

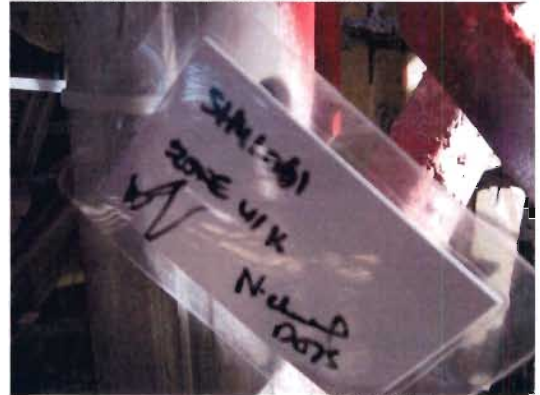

SH41061\_1



SH41061\_2

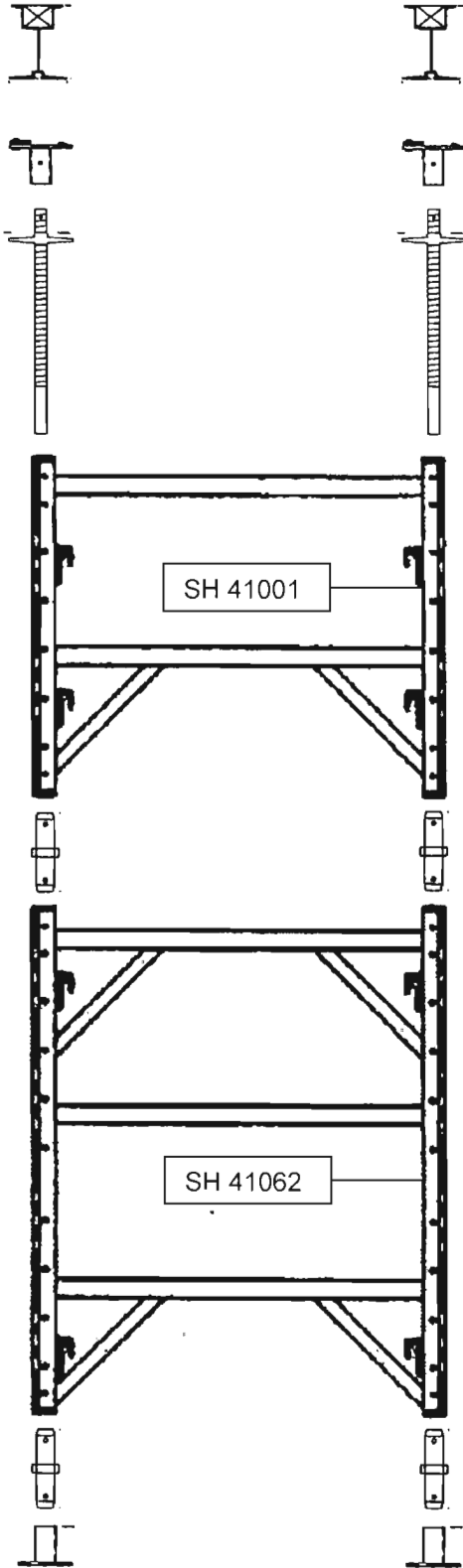

SH 41062  
 Bottom of SH 41001  
 Zone 41K

Folder: 08-02-11; 08-02-11; SH 41062

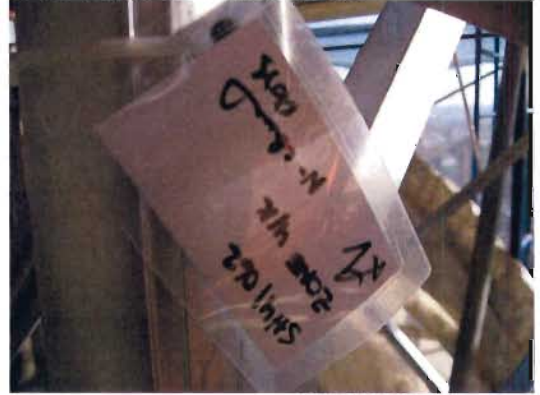

SH41062\_2

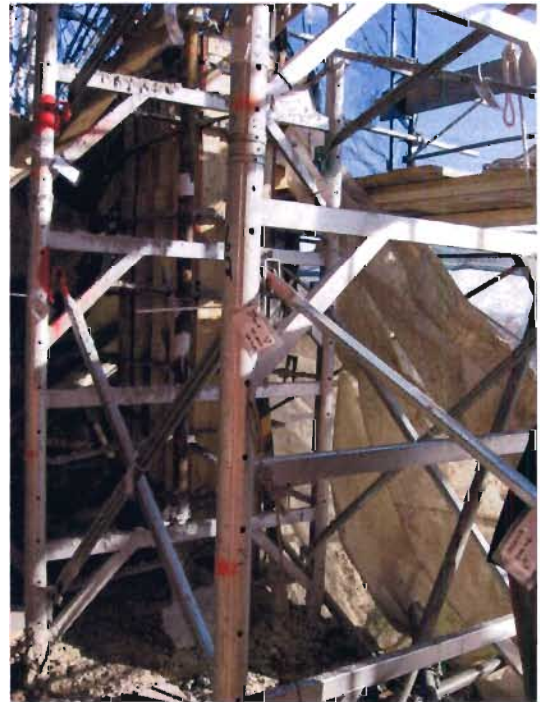

SH41062\_3

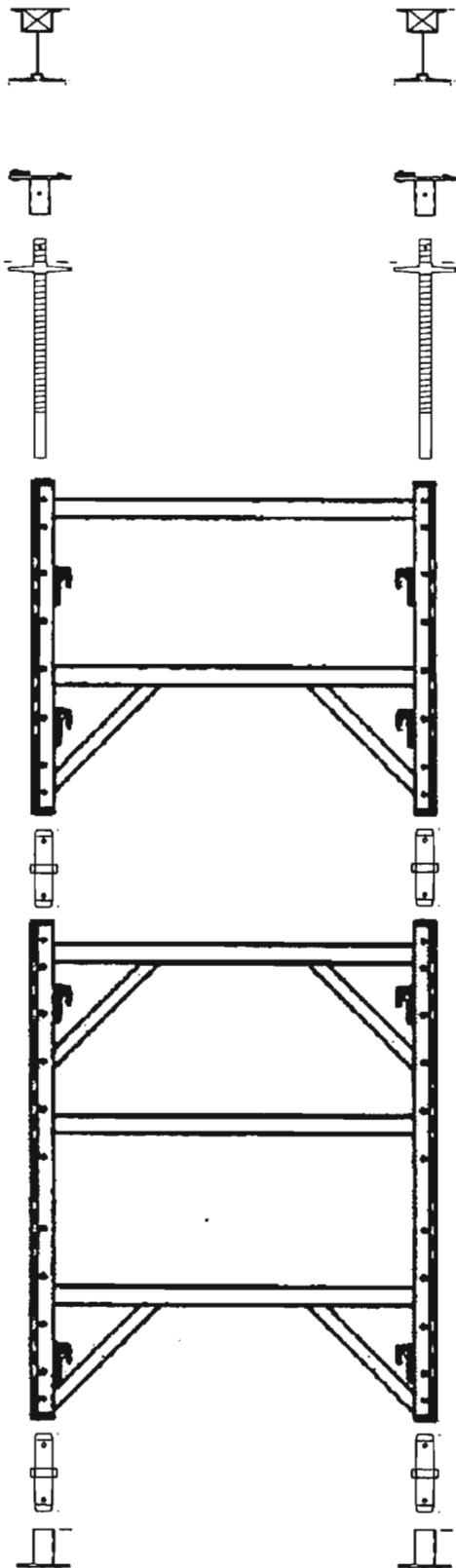

SH 41063  
 Brace  
 Connects SH 41062 to SH 41061  
 Zone 41K

Folder: 08-02-11; 08-02-11; SH 41063



SH41063\_1



SH41063\_2

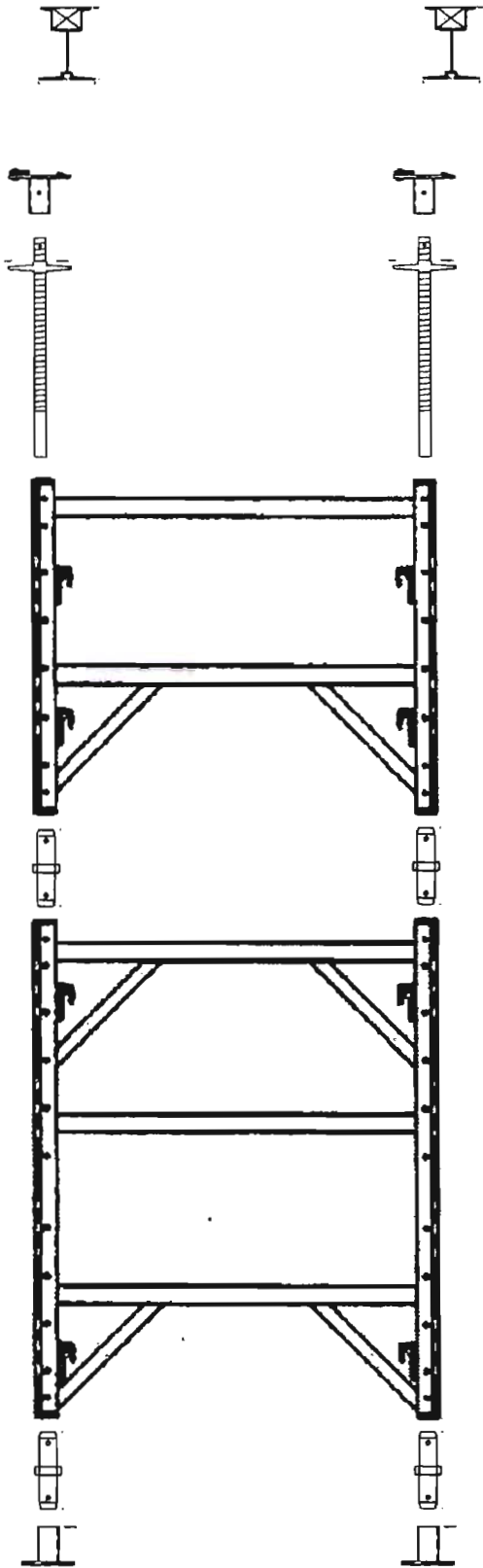

SH 41064  
 Brace  
 Connects SH 41062 to SH 41061  
 Zone 41K

Folder: 08-02-11; 08-02-11; SH 41064



SH41064\_1



SH41064\_2



SH41064\_3

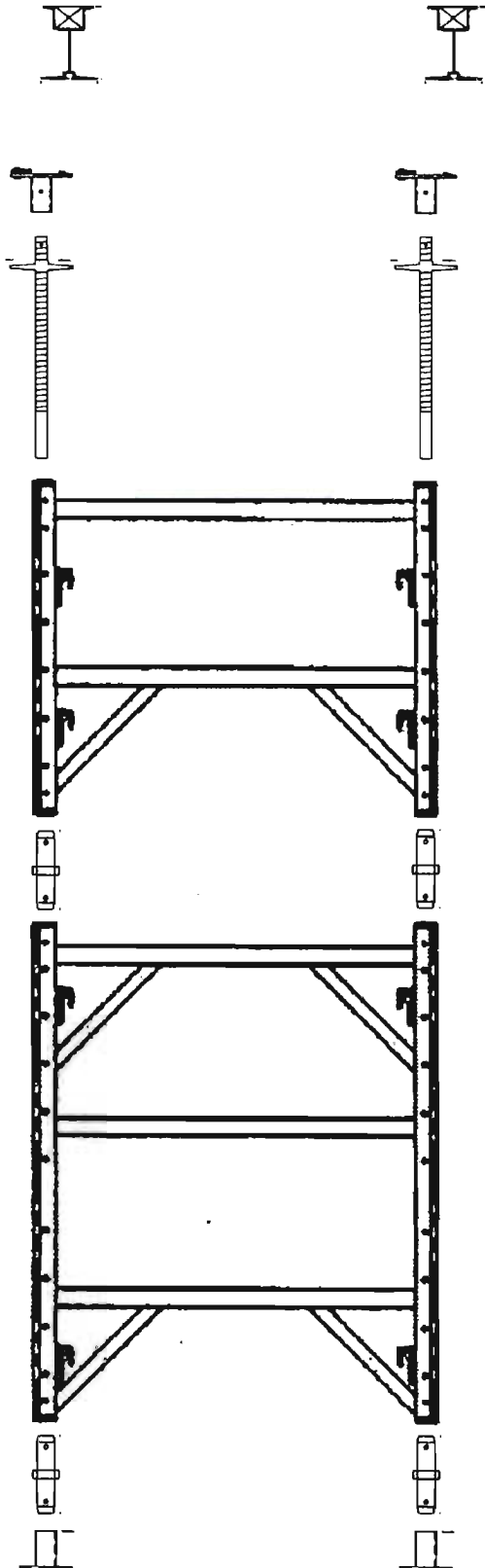

SH 41065  
 Brace  
 Connects SH 41001 to SH 41002  
 Zone 41K

Folder: 08-02-11; 08-02-11; SH 41065

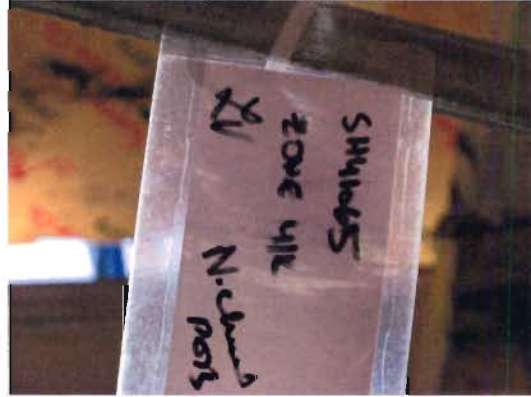

SH41065\_1



SH41065\_2



SH 41066  
Brace  
Connects SH 41001 to SH 41002  
Zone 41K

Folder: 08-02-11; 08-02-11; SH 41066

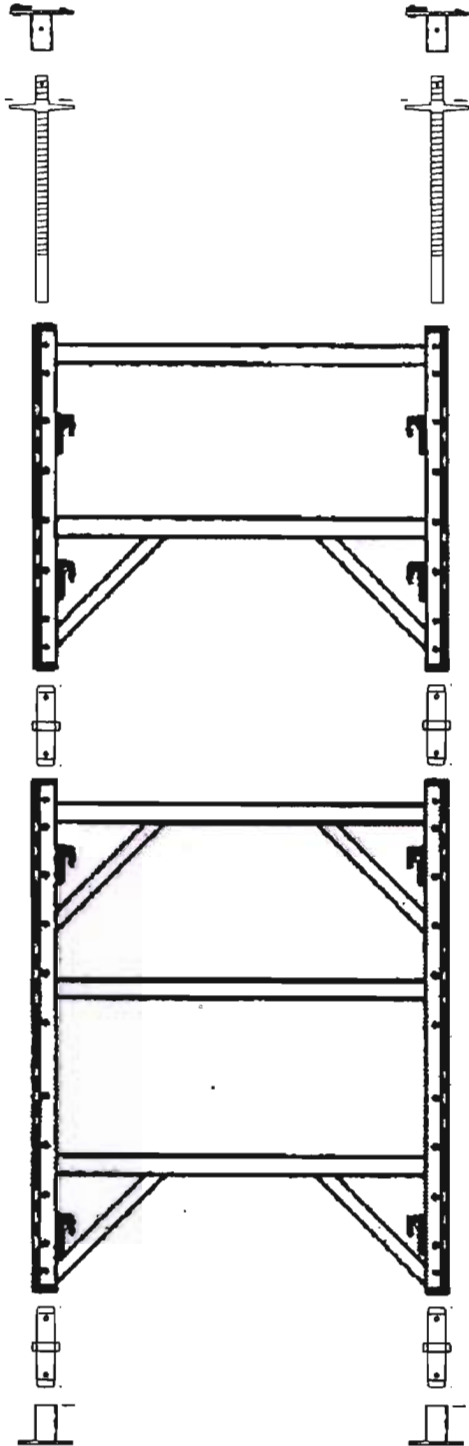

SH41066\_1



SH41066\_2





SH 41067  
 Brace connect to bottom SH 41062  
 Zone 41K

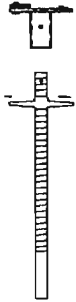
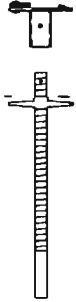

Folder: 08-02-11; 08-02-11; SH 41067

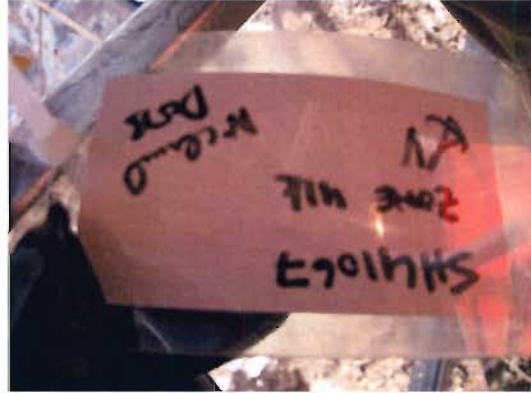

SH41067\_1

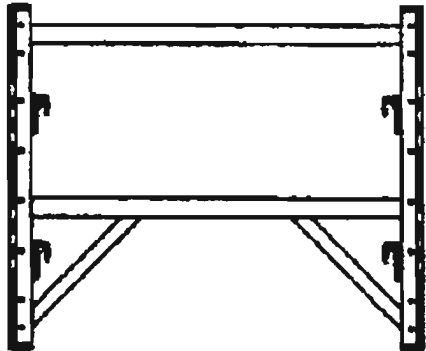

SH41067\_2

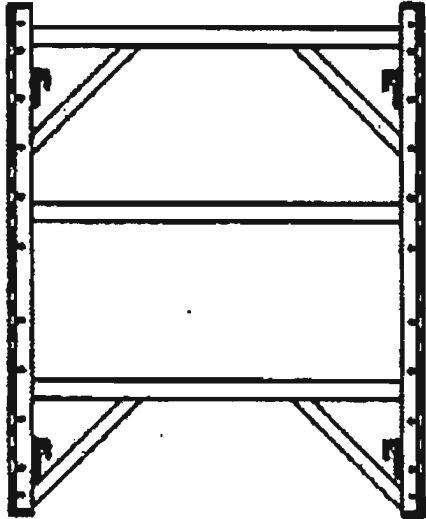

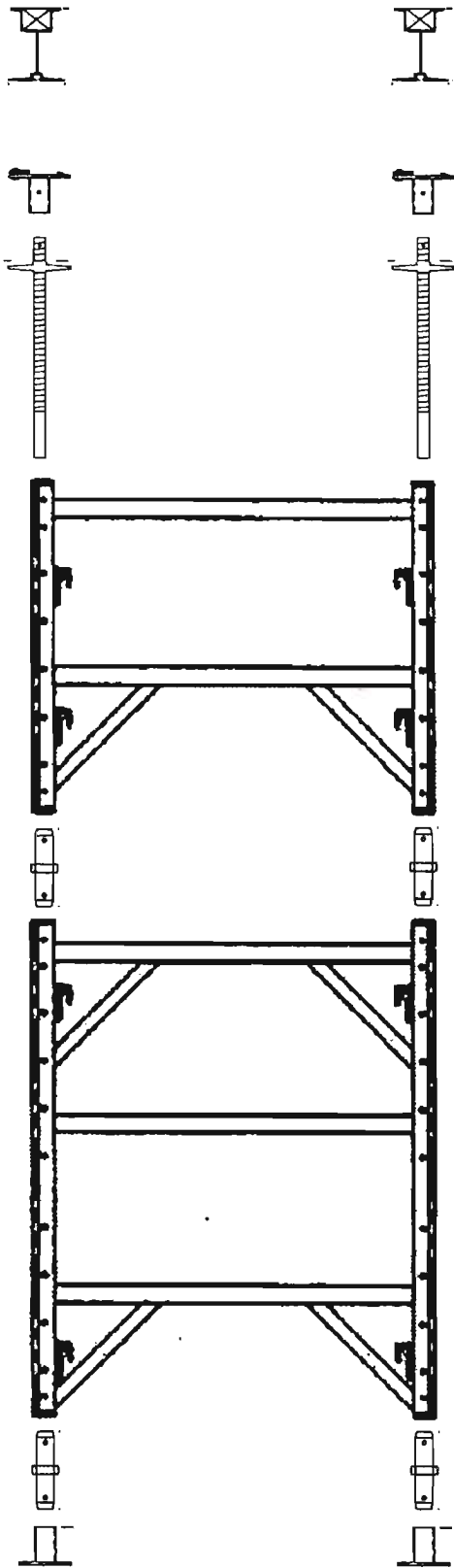

SH 41068  
 Brace connecting SH 41062 to SH 41083

Folder: 08-02-11; 08-02-11; SH 41068

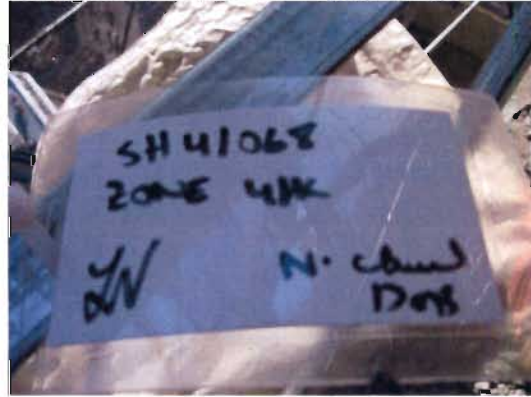

SH41068\_1



SH41067\_2

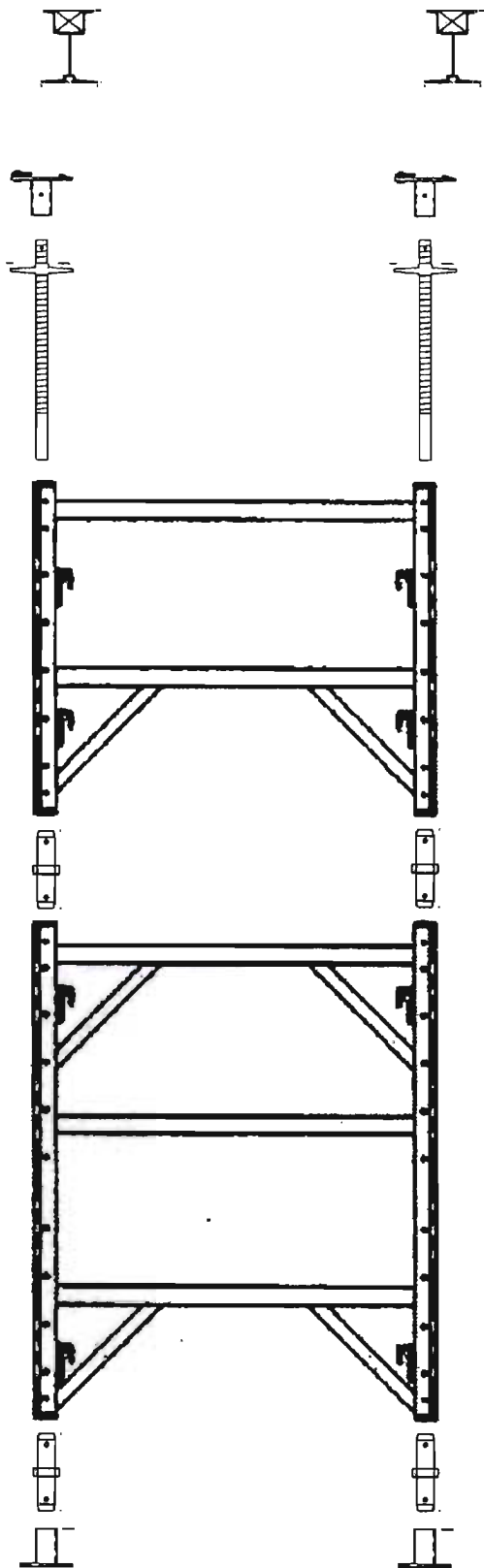

SH 41069  
 Top Brace  
 Connect SH 41001 to SH 41084  
 Zone 41K

Folder: 08-02-11; 08-02-11; SH 41069



SH41069\_1



SH41069\_2

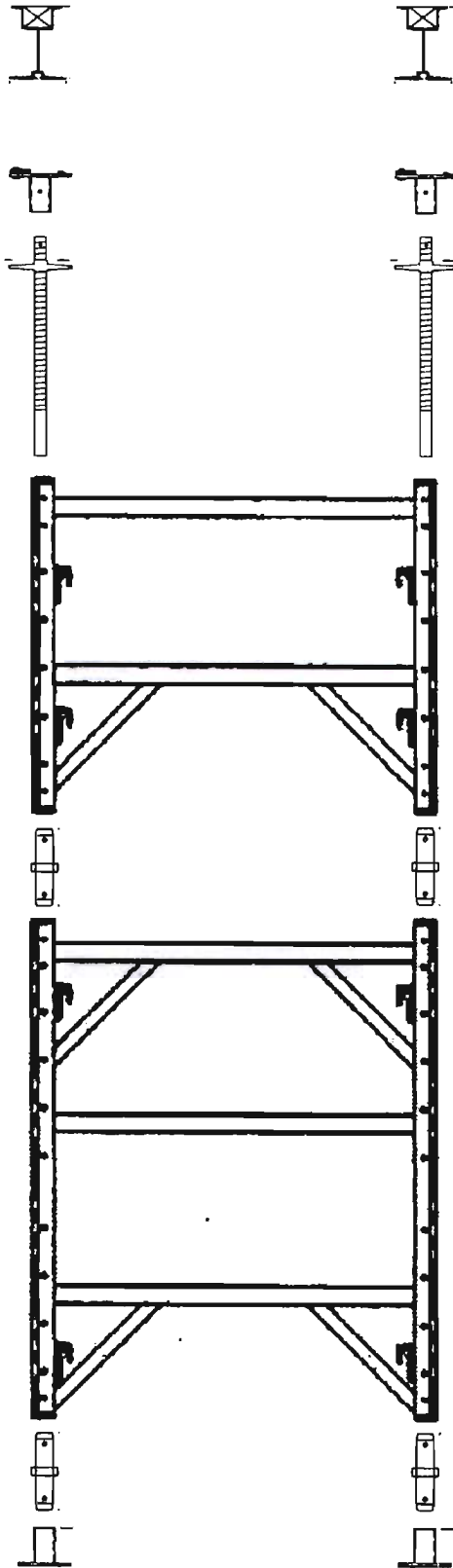

SH 41070  
 Brace  
 Connect SH 41001 to SH 41084  
 Zone 41K

Folder: 08-02-11; 08-02-11; SH 41070

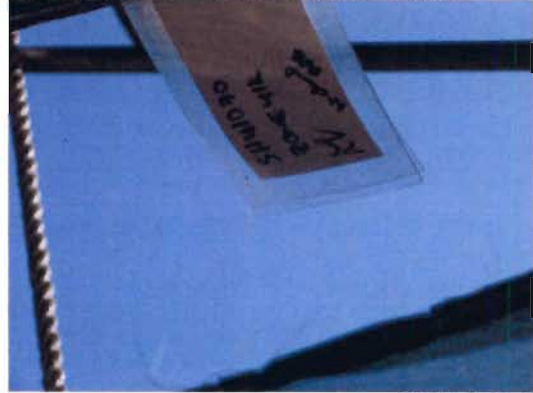

SH41070\_1



SH41070\_2

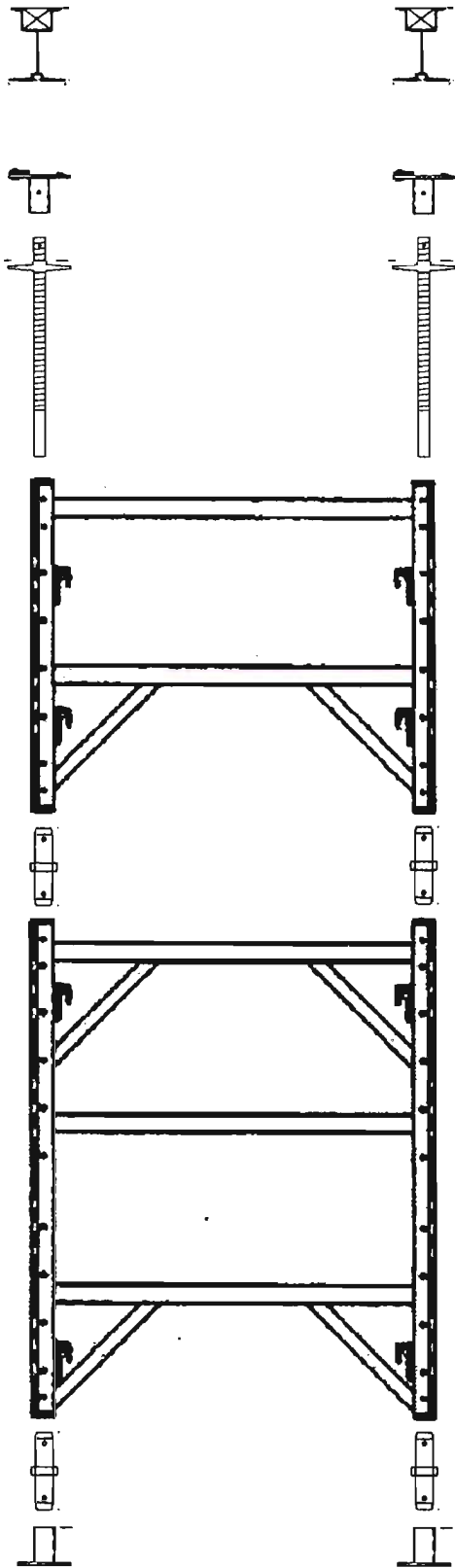

SH 41071  
 Brace  
 Connect SH 41074 to SH 41075  
 Zone 41K

Folder: 08-02-11; 08-02-11; SH 41071



SH41071\_1



SH41071\_2

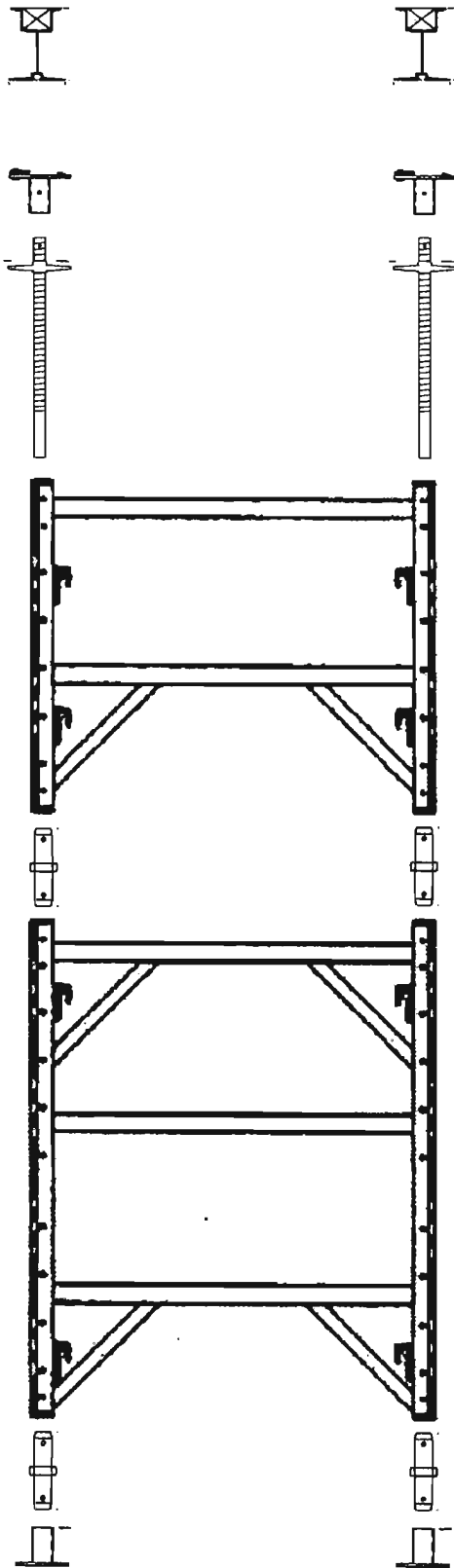

SH 41072  
 Brace connects SH 41075  
 Zone 41K

Folder: 08-02-11; 08-02-11; SH 41072



SH41072\_1



SH41072\_2

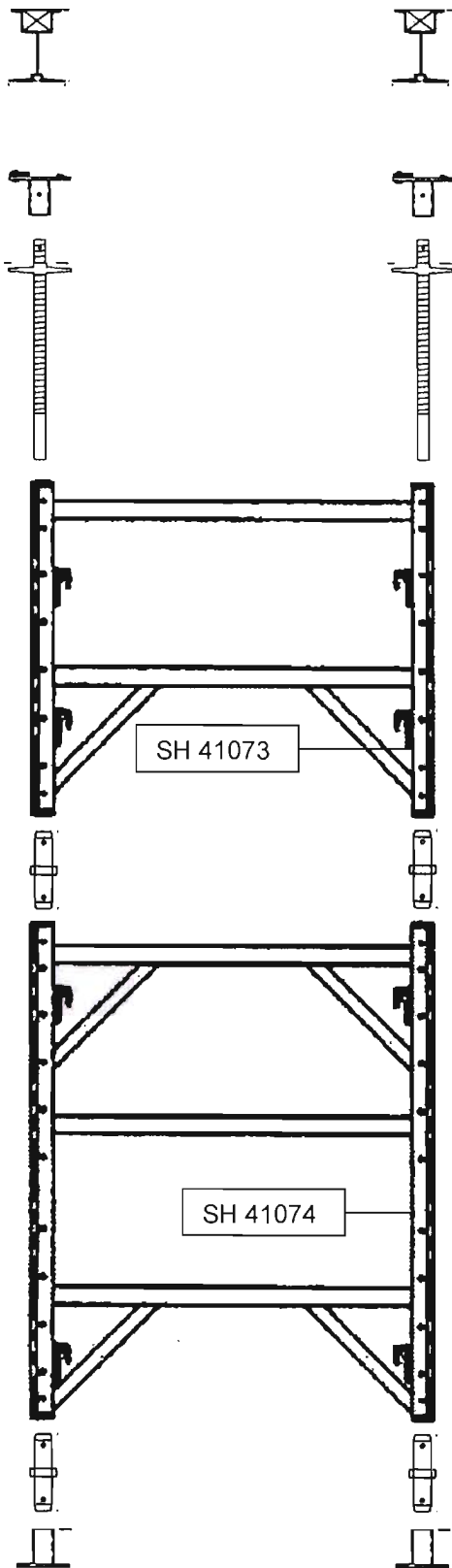

SH 41073  
 Top of SH 41074  
 Connects to top brace SH 41081  
 Connects to bottom brace SH 41071  
 Zone 41K

Folder: 08-02-11; 08-02-11; SH 41073



SH41073\_1



SH41073\_2

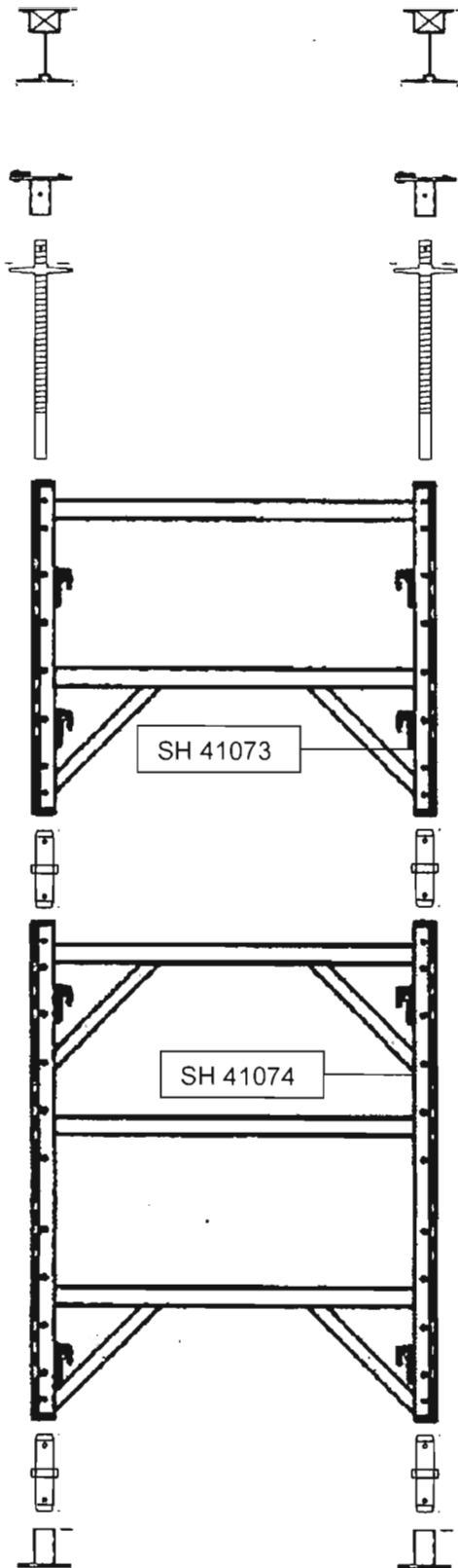

SH 41074  
 Bottom Frame of SH 41073  
 Connects to SH 41071 and SH 41072  
 Zone 41K

Folder: 08-02-11; 08-02-11; SH 41074



SH41074\_1

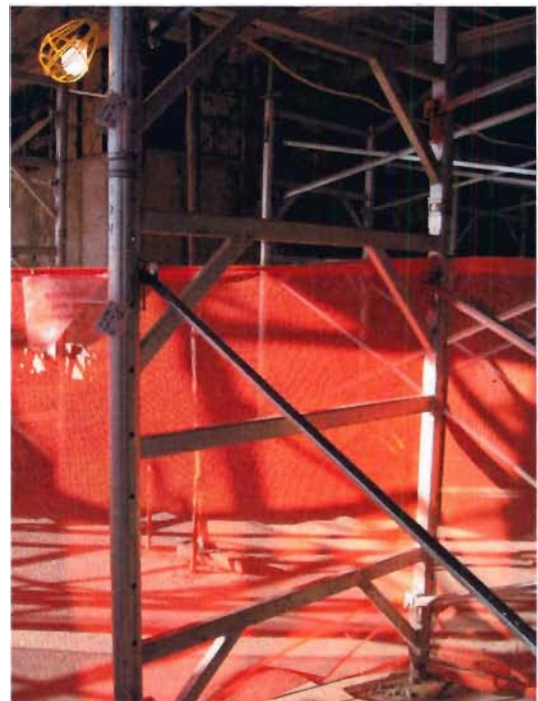

SH41074\_2



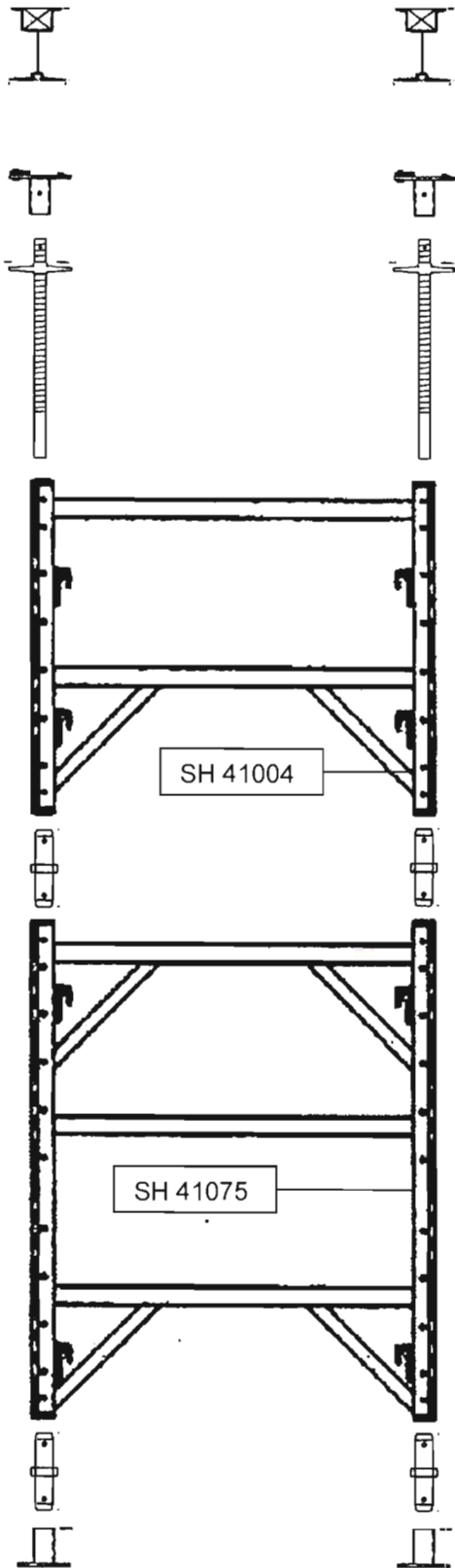

SH 41075  
 Bottom Frame of SH 41004  
 Connects to braces SH 41071 and SH 41072  
 Zone 41K

Folder: 08-02-11; 08-02-11; SH 41075

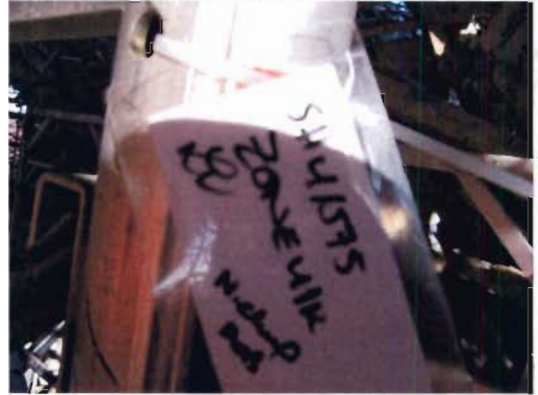

SH41075\_1



SH41075\_2

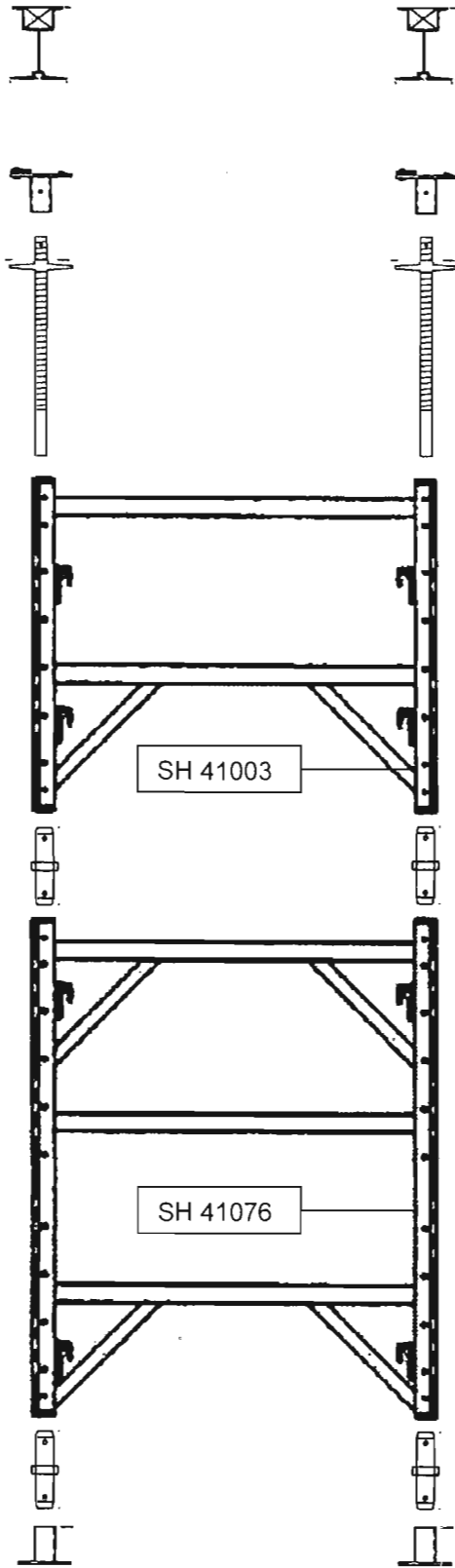

SH 41076  
 Bottom Frame of SH 41003  
 Zone 41K

Folder: 08-02-11; 08-02-11; SH 41076



SH41076\_1



SH41076\_2

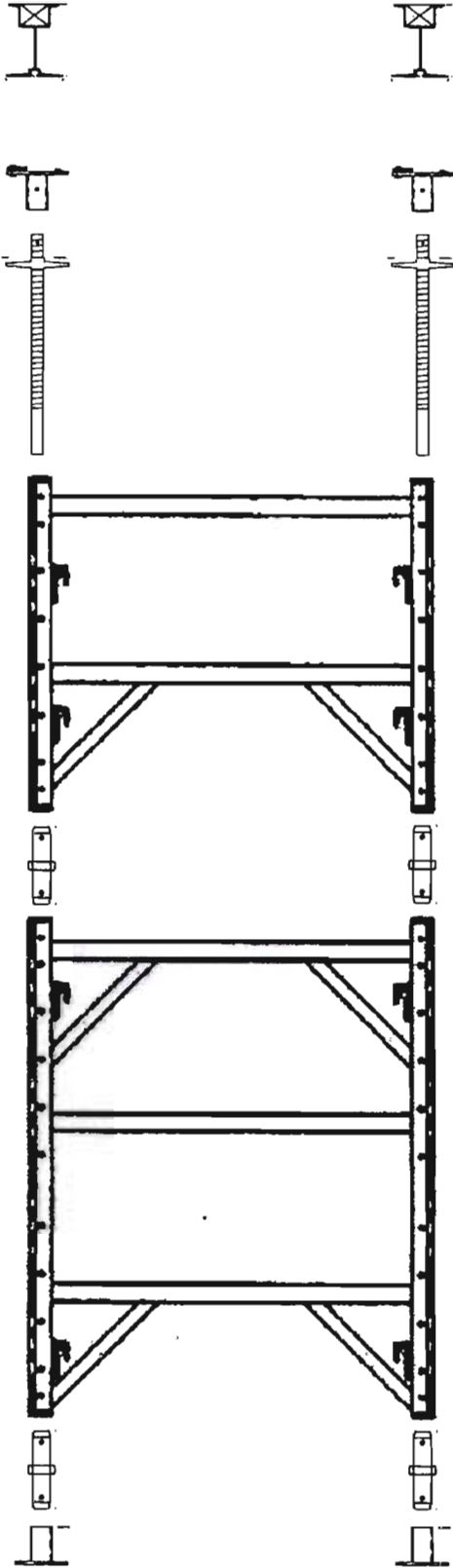

SH 41077  
 Brace connects SH 41075 to SH 41076  
 Zone 41K

Folder: 08-02-11; 08-02-11; SH 41077



SH41077\_1



SH41077\_2



SH 41078  
Brace connects SH 410745 to SH 41076  
Zone 41K

Folder: 08-02-11; 08-02-11; SH 41078

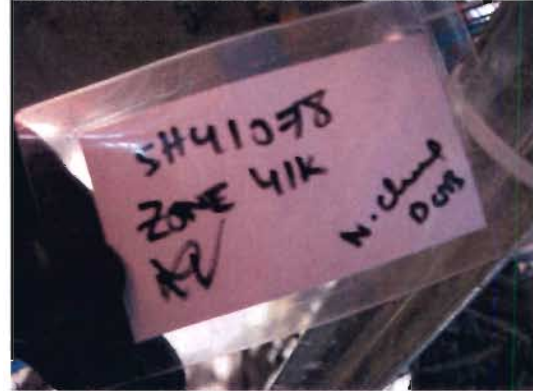
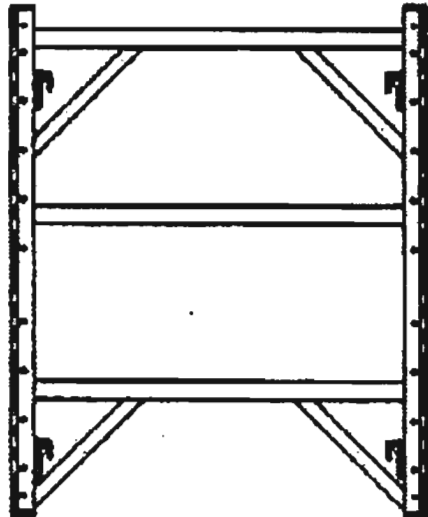
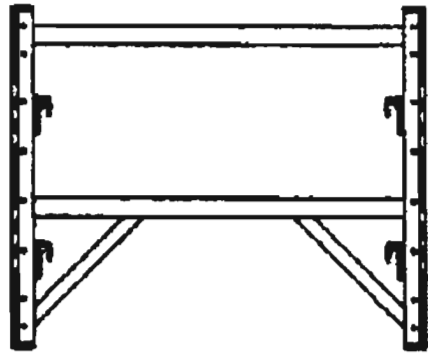

SH41078\_1



SH41078\_2